



KARUMO TECHNICAL
TRAINING INSTITUTE

**PROPOSED CONSTRUCTION OF ADMINISTRATION AND TUITION
COMPLEX - PHASE 1 AT KARUMO TECHNICAL TRAINING
INSTITUTE – MERU COUNTY**

TENDER DOCUMENT
TENDER NO: KTTI/CONST/ADMIN&TC/001/2023-2024

CLIENT

KARUMO TECHNICAL TRAINING INSTITUTE
P.O.BOX 276-60602
KIANJAI

PROJECT MANAGER
REGIONAL WORKS OFFICER
EASTERN REGION
P.O.BOX 455-60100
EMBU

ARCHITECT
REGIONAL ARCHITECT
EASTERN REGION
P.O.BOX 455-60100
EMBU

QUANTITY SURVEYOR
REGIONAL QUANTITY SURVEYOR
EASTERN REGION
P.O.BOX 455-60100
EMBU

ELECTRICAL ENGINEER
REGIONAL ENGINEER (ELECTRICAL)
EASTERN REGION
P.O.BOX 455-60100
EMBU

STRUCTURAL ENGINEER
REGIONAL ENGINEER (STRUCTURAL)
EASTERN REGION
P.O.BOX 455-60100
EMBU

MECHANICAL ENGINEER
REGIONAL ENGINEER (MECHANICAL-B.S)
EASTERN REGION
P.O.BOX 455-60100
EMBU

MAY, 2024

**PROPOSED CONSTRUCTION OF ADMINISTRATION AND TUITION
COMPLEX - PHASE 1 AT KARUMO TECHNICAL TRAINING
INSTITUTE – MERU COUNTY**

TENDER NO: KTTI/CONST/ADMIN&TC/001/2023-2024

TENDER DOCUMENTS

Consisting

A	Contents page	(i)
B	Signature and Special notes page	(ii)
C	Standard Tender Documents for Procurement of Works:	
	Section I: Instructions to Tenderers	1
	Section II: Tender Data Sheet (TDS)	18
	Section III: Evaluation and Qualification Criteria	22
	Section IV: Tendering Forms	28
	Section V: Bills of Quantities	60
	Section VI: Specifications	73
	Section VII: Drawings	73
	Section VIII: General Conditions of Contract (GCC)	74
	Section IX: Special Conditions of Contract (SCC)	130
	Section X: Contract Forms	132
D	Preambles and pricing notes	P/1
E	Preliminaries	PN/1
F	Measured Works	BW/1
G	Provisional Sums	PS/1
H	Grand Summary	GS/1

**PROPOSED CONSTRUCTION OF ADMINISTRATION AND TUITION
COMPLEX - PHASE 1 AT KARUMO TECHNICAL TRAINING
INSTITUTE – MERU COUNTY**

TENDER NO: KTTI/CONST/ADMIN&TC/001/2023-2024

Prepared by: -
Regional Works Office
Eastern Region
P. O. Box 455-60100,
Embu.

The contract for the above-mentioned works entered into this..... day of 20...
by the undersigned refers to these Tender Documents and the MINISTRY OF LANDS, PUBLIC
WORKS , HOUSING, URBAN DEVELOPMENT & and public General Specification dated March,
1976 (together with any amendments issued thereto) shall be read and construed as part of the said
contract.

.....
THE CONTRACTOR

.....
**PRINCIPAL, KARUMO TECHNICAL
TRAINING INSTITUTE**

Date :

Date:

SPECIAL NOTES

The Contractor is required to check the numbers of the pages of these Bills of Quantities and should
he find any missing or in duplicate or figures indistinct he must inform the Regional Works Officer,
Eastern Region at once and have the same rectified.

Should the Contractor be in doubt about the precise meaning of any item or figure for any reason
whatsoever, he must inform the Regional Works Officer, Eastern Region in order that the correct
meaning may be decided before the date for submission of tenders.

No liability will be admitted nor claim allowed in respect of errors in the Contractor’s Tender due to
mistakes in the specifications, which should have been rectified in the manner, described above.

SIGNATURE PAGE AND NOTES

TABLE OF CONTENTS

INVITATION TO TENDER.....	v
PART 1: TENDERING PROCEDURES.....	1
SECTION I - INSTRUCTIONS TO TENDERERS	1
A. GENERAL PROVISIONS	1
1.0 Scope of tender.....	1
2.0 Fraud and corruption	1
3.0 Eligible tenderers.....	1
4.0 Eligible goods, equipment, and services.....	3
5.0 Tenderer's responsibilities.....	3
B. CONTENTS OF TENDER DOCUMENTS.....	4
6.0 Sections of Tender Document	4
7.0 Clarification of Tender Document, Site Visit,Pre-tender Meeting.....	4
8.0 Amendment of Tender Documents.....	5
10.0 Language of Tender.....	5
11.0 Documents Comprising the Tender.....	5
12.0 Form of Tender and Schedules.....	6
13.0 Alternative Tenders	6
14.0 Tender Prices and Discounts	6
15.0 Currencies of Tender and Payment.....	6
16.0 Documents Comprising the Technical Proposal	7
17.0 Documents Establishing the Eligibility and Qualifications of The Tenderer.....	7
18.0 Period of Validity of Tenders	8
19.0 Tender Security	8
20.0 Format and Signing ofTender	9
D. SUBMISSION AND OPENING OF TENDERS.....	11
21.0 Sealing and Marking of Tenders	11
22.0 Deadline for Submission of Tenders	11
23.0 Late Tenders.....	11
24.0 Withdrawal, Substitution, and Modification of Tenders.....	11
25.0 Tender Opening	12
E. EVALUATION AND COMPARISON OF TENDERS.....	12
26.0 Confidentiality.....	12
27.0 Clarification of Tenders.....	13
29.0 Determination of Responsiveness	13
30.0 Non-material Non-conformities	13
31.0 Arithmetical Errors.....	14
33.0 Margin of PreferenceandReservations.....	14
34.0 Nominated Subcontractors.....	14
35.0 Evaluation of Tenders	15
36.0 Comparison of tenders.....	15
37.0 Abnormally low tenders and abnormally high tenders.....	15
Abnormally LowTenders.....	15
Abnormally high tenders	15
38.0 Unbalanced and/or front-loaded tenders.....	16
39.0 Qualifications of the tenderer	16
40.0 Lowest evaluated tender	16
41.0 Procuring entity's right to accept any tender, and to reject any orall tenders.....	16

F. AWARD OF CONTRACT	17
42.0 Award criteria.....	17
43.0 Notice of intention to enter into a contract	17
44.0 Standstill Period	17
44.0 Standstill Period	17
45.0 Debriefing By The Procuring Entity	17
46.0 Letter of Award	17
47.0 Signing of Contract	17
48.0 Performance Security.....	17
49.0 Publication of Procurement Contract	18
50.0 Procurement related Complaint	18
SECTION II - TENDER DATA SHEET (TDS).....	18
SECTION III - EVALUATION AND QUALIFICATION CRITERIA	22
1. General Provisions.....	22
2. Preliminary examination for Determination of Responsiveness	22
3. Tender Evaluation.....	22
4. Multiple Contracts	22
5. AlternativeTenders	23
6. Margin of Preference	23
7. Post qualification and Contract Award	23
8. QUALIFICATION FORM	25
SECTION IV –TENDERING FORMS.....	28
1. FOREIGN TENDERERS 40% RULE	28
2. Form EQU: EQUIPMENT.....	29
3. FORM PER - 1:.....	30
4. FORM PER - 2:.....	31
5. TENDERERS QUALIFICATION WITHOUT PRE-QUALIFICATION	33
OTHER FORMS	43
1. FORM OF TENDER	43
a) TENDERER'S ELIGIBILITY- CONFIDENTIALBUSINESS QUESTIONNAIRE	46
b) CERTIFICATE OF INDEPENDENTTENDERDETERMINATION	50
c) SELF-DECLARATION FORM - SELF DECLARATION OFTHETENDERER.....	51
d) APPENDIX 1 - FRAUD AND CORRUPTION	54
2. FORM OF TENDER SECURITY - DEMANDBANKGUARANTEE	56
3. FORM OF TENDER SECURITY (TENDER BOND).....	57
4. FORM OF TENDER-SECURING DECLARATION	58
5. APPENDIX TO TENDER.....	59
SECTION V – BILLS OF QUANTITIES.....	60
1. PREAMBLES	63
2. Bill No. 1 – Preliminary Items	67
3. Bill No. 2: Work Items	38
4. Bill No. 3: Schedule of Daywork Rates - Labour.....	69
5. Bill No. 3: Schedule of Daywork Rates - Materials	70
6. Bill No. 3: Schedule of Daywork Rates - Contractor's Equipment.....	71
7. Bill No. 3: Daywork Summary.....	71
8. Bill No. 4: Provisional Sums	72
9. GRAND SUMMARY	72

SECTION VI - SPECIFICATIONS..... 73

SECTION VII - DRAWINGS..... 73

SECTION VIII - GENERAL CONDITIONS OF CONTRACT (GCC)..... 74

1. General Provisions 74

2. The Procuring Entity 80

3. The Engineer 81

4. The Contractor 83

5. Nominated Subcontractors 91

6. Staff and Labor 92

7. Plant, Materials and Workmanship 95

8. Commencement, Delays and Suspension 97

9. Tests on Completion 100

10. Procuring Entity's Taking Over 100

11. Defects Liability 102

12. Measurement and Evaluation 104

13. Variations and Adjustments 105

14. Contract Price and Payment 109

15. Termination by Procuring Entity 115

16. Suspension and Termination by Contractor 117

17. Risk and Responsibility 119

18. Insurance 121

19. Force Majeure 124

20. Settlement of Claims and Disputes 126

Section IX - Special Conditions of Contract 130

SECTION X – CONTRACT FORMS..... 132

FORM No. 1 - NOTIFICATION OF INTENTION TO AWARD 133

FORM No. 2 - NOTIFICATION OF AWARD - LETTER OF ACCEPTANCE 135

FORM No. 3 – CONTRACT AGREEMENT 136

FORM No. 4 - PERFORMANCE SECURITY [Option 1 - Unconditional Demand Bank Guarantee] 137

FORM No. 5- PERFORMANCE SECURITY [Option 2 – Performance Bond] 138

FORM No. 6 – ADVANCE PAYMENT SECURITY 140

FORM No. 7 – RETENTION MONEY SECURITY 141



KARUMO TECHNICAL TRAINING INSTITUTE

TENDER DOCUMENTS FOR PROCUREMENT OF WORKS (BUILDING AND ASSOCIATED CIVIL ENGINEERING WORKS)

1) NAME AND CONTACT ADDRESSES OF PROCURING ENTITY

Name: **KARUMO TECHNICAL TRAINING INSTITUTE**

Address: **P.O.BOX 276-60602 KIANJAI**

Email address: *as indicated in the tender advertisement*

2) Invitation to Tender (ITT) No: *as indicated in the tender advertisement*

3) Tender Name: **PROPOSED CONSTRUCTION OF ADMINISTRATION AND TUITION COMPLEX – PHASE 1 AT KARUMO TECHNICAL TRAINING INSTITUTE - MERU COUNTY**

INVITATION TO TENDER

PROCURING ENTITY: KARUMO TECHNICAL TRAINING INSTITUTE

CONTRACT NAME AND DESCRIPTION: PROPOSED CONSTRUCTION OF ADMINISTRATION AND TUITION COMPLEX – PHASE 1 AT KARUMO TECHNICAL TRAINING INSTITUTE- MERU COUNTY

1. The *Principal, Karumo Technical Training Institute* invites sealed tenders for the construction of the ***PROPOSED CONSTRUCTION OF ADMINISTRATION AND TUITION COMPLEX – PHASE 1 AT KARUMO TECHNICAL TRAINING INSTITUTE – MERU COUNTY***
2. Tendering will be conducted under open competitive method National using a standardized tender document. Tendering is open to all qualified and interested Tenderers.
3. Qualified and interested tenderers may obtain further information and inspect the Tender Documents during office hours *0900 to 1700 hours* at the address given below.
4. Tender documents may be viewed and downloaded for free from the Public Procurement Information Portal (PIIP) or institute website (*as per tenderadvert*).
5. Tenderers who download the tender document must forward their particulars immediately to karumotti@gmail.com to facilitate any further clarification or addendum.
6. Tenders shall be quoted be in Kenya Shillings and shall include all taxes. Tenders shall remain valid for 120 days from the date of opening of tenders.
7. All Tenders must be accompanied by a *tender Security of Kenya Shillings 855,000*
8. The Tenderer shall chronologically serialize all pages of the tender documents submitted.
9. Completed tenders must be delivered to the address below on or before *as per tender advert*.

Electronic Tenders *will not be* permitted.
10. Tenders will be opened immediately after the deadline date and time specified above or any dead line date and times pecified later. Tenders will be publicly opened in the presence of the Tenderers' designated representatives who choose to attend at the address below.
11. Late tenders will be rejected.
12. The addresses referred to above are:

A. Address for obtaining further information and for purchasing tender documents

Name of Procuring Entity:

- (1) KARUMO TECHNICAL TRAINING INSTITUTE
- (2) Physical address for hand Courier Delivery to an office or Tender Box (*As indicated in tender advertisement*)
- (3) Postal Address: P.O.BOX 276-60602 KIANJAI
- (4) Insert name, telephone number and e-mail address of the officer to be contacted.

B. Address for Submission of Tenders.

- 1) Name of Procuring Entity: KARUMO TECHNICAL TRAINING INSTITUTE
- 2) Postal Address: P.O.BOX 276-60602 KIANJAI (Attn: The Principal)
- (I) Physical address for hand Courier Delivery to an office or Tender Box (*As indicated in tender advertisement*)

C. Address for Opening of Tenders.

- 1) Name of Procuring Entity: KARUMO TECHNICAL TRAINING INSTITUTE
- 2) Physical address for the location: P.O.BOX 276-60602 KIANJAI

THE PRINCIPAL, KARUMO TECHNICAL TRAINING INSTITUTE

Name _____
(*Official of the Procuring Entity issuing the invitation*)

Designation _____

Signature _____

Date _____

PART I: TENDERING PROCEDURES

SECTION I - INSTRUCTIONS TO TENDERERS

A GENERAL PROVISIONS

10 Scope of tender

11 The Procuring Entity as defined in the Appendix to Conditions of Contract invites tenders for Works Contract as described in the tender documents. The name, identification, and number of lots (contracts) of this Tender Document are specified in the TDS.

12 Throughout this tendering document:

- a) The term “in writing” means communicated in written form (e.g. by mail, e-mail, fax, including if specified in the TDS, distributed or received through the electronic-procurement system used by the Procuring Entity) with proof of receipt;
- b) if the context so requires, “singular” means “plural” and vice versa;
- c) “Day” means calendar day, unless otherwise specified as “Business Day”. A Business Day is any day that is an official working day of the Procuring Entity. It excludes official public holidays.

20 Fraud and corruption

21 The Procuring Entity requires compliance with the provisions of the Public Procurement and Asset Disposal Act, 2015, Section 62 “Declaration not to engage in corruption”. The tender submitted by a person shall include a declaration that the person shall not engage in any corrupt or fraudulent practice and a declaration that the person or his or her sub-contractors are not debarred from participating in public procurement proceedings.

22 The Procuring Entity requires compliance with the provisions of the Competition Act 2010, regarding collusive practices in contracting. Any tenderer found to have engaged in collusive conduct shall be disqualified and criminal and/or civil sanctions may be imposed. To this effect, Tenders shall be required to complete and sign the “Certificate of Independent Tender Determination” annexed to the Form of Tender.

23 Tenderers shall permit and shall cause their agents (whether declared or not), subcontractors, sub-consultants, service providers, suppliers, and their personnel, to permit the Procuring Entity to inspect all accounts, records and other documents relating to any initial selection process, pre-qualification process, tender submission, proposal submission, and contract performance (in the case of award), and to have them audited by auditors appointed by the Procuring Entity.

24 Unfair Competitive Advantage - Fairness and transparency in the tender process require that the firms or their Affiliates competing for a specific assignment do not derive a competitive advantage from having provided consulting services related to this tender. To that end, the Procuring Entity shall indicate in the **Data Sheet** and make available to all the firms together with this tender document all information that would in that respect give such firm any unfair competitive advantage over competing firms.

30 Eligible tenderers

31 A Tenderer may be a firm that is a private entity, a state-owned enterprise or institution subject to ITT 3.8, or an individual or any combination of such entities in the form of a joint venture (JV) under an existing agreement with the intent to enter into such an agreement supported by a letter of intent. In the case of a joint venture, all members shall be jointly and severally liable for the execution of the entire Contract in accordance with the Contract terms. The JV shall nominate a Representative who shall have the authority to conduct all business for and on behalf of any and all the members of the JV during the tendering process and, in the event the JV is awarded the Contract, during contract execution. Members of a joint venture may not also make an individual tender, be a subcontractor in a separate tender or be part of another joint venture for the purposes of the same Tender. The maximum number of JV members shall be specified in the **TDS**.

32 Public Officers of the Procuring Entity, their Spouses, Child, Parent, Brothers or Sister. Child, Parent, Brother or Sister of a Spouse, their business associates or agents and firms/organizations in which they have a substantial or controlling interest shall not be eligible to tender or be awarded a contract. Public Officers are also not allowed to participate in any procurement proceedings.

33 A Tenderer shall not have a conflict of interest. Any tenderer found to have a conflict of interest shall be disqualified. A tenderer may be considered to have a conflict of interest for the purpose of this tendering process, if the tenderer:

- a) Directly or indirectly controls, is controlled by or is under common control with an other tenderer;
 - b) Receives or has received any director indirect subsidy from another tenderer;
 - c) Has the same legal representative as an other tenderer;
 - d) Has a relationship with an other tenderer, directly or through common third parties, that puts it in a position to influence the tender of an other tenderer, or influence the decisions of the Procuring Entity regarding this tendering process;
 - e) Any of its affiliates participated as a consultant in the preparation of the design or technical specifications of the goods or works that are the subject of the tender;
 - f) Any of its affiliates has been hired (or is proposed to be hired) by the Procuring Entity as a consultant for Contract implementation;
 - g) Would be providing goods, works, or non-consulting services resulting from or directly related to consulting services for the preparation or implementation of the contract specified in this Tender Document;
 - h) Has a close business or personal relationship with senior management or professional staff of the Procuring Entity who has the ability to influence the bidding process and:
 - i) Are directly or indirectly involved in the preparation of the Tender document or specifications of the Contract, and/or the Tender evaluation process of such contract; or
 - ii) May be involved in the implementation or supervision of such Contract unless the conflicts stemming from such relationship has been resolved in a manner acceptable to the Procuring Entity throughout the tendering process and execution of the Contract.
- 34 A tenderer shall not be involved in corrupt, coercive, obstructive or fraudulent practice. A tenderer that is proven to have been involved in any of these practices shall be automatically disqualified
- 35 A Tenderer (either individually or as a JV member) shall not participate in more than one Tender, except for permitted alternative tenders. This includes participation as a subcontractor in other Tenders. Such participation shall result in the disqualification of all Tenders in which the firm is involved. Members of a joint venture may not also make an individual tender, be a sub-contractor in a separate tender or be part of another joint venture for the purposes of the same Tender. A firm that is not a tenderer or a JV member may participate as a subcontractor in more than one tender.
- 36 A Tenderer may have the nationality of any country, subject to the restrictions pursuant to ITT3.9. A Tenderer shall be deemed to have the nationality of a country if the Tenderer is constituted, incorporated or registered in and operates in conformity with the provisions of the laws of that country, as evidenced by its articles of incorporation (or equivalent documents of constitution or association) and its registration documents, as the case may be. This criterion also shall apply to the determination of the nationality of proposed sub-contractors or sub-consultants for any part of the Contract including related Services.
- 37 A Tenderer that has been debarred from participating in public procurement shall be ineligible to tender or be awarded a contract. The list of debarred firms and individuals is available from the website of PPR www.ppra.go.ke.
- 38 A Tenderer that is a state-owned enterprise or a public institution in Kenya may be eligible to tender and be awarded Contract(s) only if it is determined by the Procuring Entity to meet the following conditions, i.e. if it is:
- i) A legal public entity of Government and/or public administration,
 - ii) financially autonomous and not receiving any significant subsidies or budget support from any public entity or Government, and;
 - (iii) Operating under commercial law and vested with legal rights and liabilities similar to any commercial enterprise to enable it compete with firms in the private sector on an equal basis.
- 39 Firms and individuals shall be ineligible if their countries of origin are:
- (a) As a matter of law or official regulations, Kenya prohibits commercial relations with that country;
 - (b) By an act of compliance with a decision of the United Nations Security Council taken under Chapter VII of the Charter of the United Nations, Kenya prohibits any import of goods or contracting of works or services from that country, or any payments to any country, person, or entity in that country.

A tenderer shall provide such documentary evidence of eligibility satisfactory to the Procuring Entity, as the Procuring Entity shall reasonably request.

- 3.10 Foreign tenderers are required to source at least forty (40%) percent of their contract inputs (in supplies, local sub-contracts and labor) from citizen suppliers and contractors. To this end, a foreign tenderer shall provide in its tender documentary evidence that this requirement is met. Foreign tenderers not meeting this criterion will be automatically disqualified. Information required to enable the Procuring Entity determine if this condition is met shall be provided for this purpose in “*SECTION III - EVALUATION AND QUALIFICATION CRITERIA, Item 9*”.
- 3.11 Pursuant to the eligibility requirements of ITT 3.10, a tender is considered a foreign tenderer, if it is registered in Kenya and has less than 51 percent ownership by nationals of Kenya and if it does not subcontract to foreign firms or individuals more than 10 percent of the contract price, excluding provisional sums. JVs are considered as foreign tenderers if the individual member firms registered in Kenya have less 51 percent ownership by nationals of Kenya. The JV shall not subcontract to foreign firms more than 10 percent of the contract price, excluding provisional sums.
- 3.12 The National Construction Authority Act of Kenya requires that all local and foreign contractors be registered with the National Construction Authority and be issued with a Registration Certificate before they can undertake any construction works in Kenya. Registration shall not be a condition for tender, but it shall be a condition of contract award and signature. A selected tenderer shall be given opportunity to register before such award and signature of contract. Application for registration with National Construction Authority may be accessed from the website www.nca.go.ke.
- 3.13 The Competition Act of Kenya requires that firms wishing to tender as Joint Venture undertakings which may prevent, distort or lessen competition in provision of services are prohibited unless they are exempt in accordance with the provisions of Section 25 of the Competition Act, 2010. JVs will be required to seek for exemption from the Competition Authority. Exemption shall not be a condition for tender, but it shall be a condition of contract award and signature. A JV tenderer shall be given opportunity to seek such exemption as a condition of award and signature of contract. Application for exemption from the Competition Authority of Kenya may be accessed from the website www.cak.go.ke.
- 3.14 A Kenyan tenderer shall be eligible to tender if it provides evidence of having fulfilled his/her tax obligations by producing valid tax compliance certificate or tax exemption certificate issued by the Kenya Revenue Authority.

40 Eligible goods, equipment, and services

- 41 Goods, equipment and services to be supplied under the Contract may have their origin in any country that is not ineligible under ITT 3.9. At the Procuring Entity's request, Tenderers may be required to provide evidence of the origin of Goods, equipment and services.
- 42 Any goods, works and production processes with characteristics that have been declared by the relevant national environmental protection agency or by other competent authority as harmful to human beings and to the environment shall not be eligible for procurement.

50 Tenderer's responsibilities

- 51 The tenderer shall bear all costs associated with the preparation and submission of his/her tender, and the Procuring Entity will in no case be responsible or liable for those costs.
- 52 The tenderer, at the tenderer's own responsibility and risk, is encouraged to visit and examine and inspect the Site of the Works and its surroundings and obtain all information that may be necessary for preparing the tender and entering into a contract for construction of the Works. The costs of visiting the Site shall be the tenderer's own expense.
- 53 The Tenderer and any of its personnel or agents will be granted permission by the Procuring Entity to enter upon its premises and lands for the purpose of such visit. The Tenderer shall indemnify the Procuring Entity against liability arising from death or personal injury, loss of or damage to property, and any other losses and expenses incurred as a result of the examination and inspection.

- 54 The tenderer shall provide in the Form of Tender and Qualification Information, a preliminary description of the proposed work method and schedule, including charts, as necessary or required.

B. CONTENTS OF TENDER DOCUMENTS

60 Sections of Tender Document

- 61 The tender document consists of Parts 1, 2, and 3, which includes all the sections specified below, and which should be read in conjunction with any Addenda issued in accordance with ITT 10.

PART 1: Tendering Procedures

Section I – Instructions to Tenderers

Section II – Tender Data Sheet (TDS)

Section III- Evaluation and Qualification

Criteria Section IV – Tendering Forms

PART 2: Works' Requirements

Section V - Bills of Quantities

Section VI - Specifications

Section VII - Drawings

PART 3: Conditions of Contract and Contract Forms

Section VIII - General Conditions (GCC)

Section IX - Special Conditions of Contract

Section X- Contract Forms

- 62 The Invitation to Tender Notice issued by the Procuring Entity is not part of the Contract documents. Unless obtained directly from the Procuring Entity, the Procuring Entity is not responsible for the completeness of the Tender document, responses to requests for clarification, the minutes of a pre-arranged site visit and those of the pre-Tender meeting (if any), or Addenda to the Tender document in accordance with ITT 10. In case of any contradiction, documents obtained directly from the Procuring Entity shall prevail.

- 63 The Tenderer is expected to examine all instructions, forms, terms, and specifications in the Tender Document and to furnish with its Tender all information and documentation as is required by the Tender document.

70 Clarification of Tender Document, Site Visit, Pre-tender Meeting

- 71 A Tenderer requiring any clarification of the Tender Document shall contact the Procuring Entity in writing at the Procuring Entity's address specified in the **TDS** or raise its enquiries during the pre-Tender meeting if provided for in accordance with ITT 7.2. The Procuring Entity will respond in writing to any request for clarification, provided that such request is received no later than the period specified in the **TDS** prior to the deadline for submission of tenders. The Procuring Entity shall forward copies of its response to all tenderers who have acquired the Tender documents in accordance with ITT 7.4, including a description of the inquiry but without identifying its source. If so specified in the **TDS**, the Procuring Entity shall also promptly publish its response at the web page identified in the **TDS**. Should the clarification result in changes to the essential elements of the Tender Documents, the Procuring Entity shall amend the Tender Documents following the procedure under ITT 8 and ITT 22.2.

- 72 The Tenderer, at the Tenderer's own responsibility and risk, is encouraged to visit and examine and inspect the site(s) of the required contracts and obtain all information that may be necessary for preparing a tender. The costs of visiting the Site shall be at the Tenderer's own expense. The Procuring Entity shall specify in the **TDS** if a pre-arranged Site visit and or a pre-tender meeting will be held, when and where. The Tenderer's designated representative is invited to attend a pre-arranged site visit and a pre-tender meeting, as the case may be. The purpose of the site visit and the pre-tender meeting will be to clarify issues and to answer questions on any matter that may be raised at that stage.

- 73 The Tenderer is requested to submit any questions in writing, to reach the Procuring Entity not later than the period specified in the **TDS** before the meeting.

- 74** Minutes of a pre-arranged site visit and those of the pre-tender meeting, if applicable, including the text of the questions asked by Tenderers and the responses given, together with any responses prepared after the meeting, will be transmitted promptly to all Tenderers who have acquired the Tender Documents. Minutes shall not identify the source of the questions asked.
- 75** The Procuring Entity shall also promptly publish anonymized (*no names*) Minutes of the pre-arranged site visit and those of the pre-tender meeting at the web page identified in the **TDS**. Any modification to the Tender Documents that may become necessary as a result of the pre-arranged site visit and those of the pre-tender meeting shall be made by the Procuring Entity exclusively through the issue of an Addendum pursuant to ITT 8 and not through the minutes of the pre-Tender meeting. Non-attendance at the pre-arranged site visit and the pre-tender meeting will not be a cause for disqualification of a Tenderer.
- 80** **Amendment of Tender Documents**
- 81** At any time prior to the deadline for submission of Tenders, the Procuring Entity may amend the Tender Documents by issuing addenda.
- 82** Any addendum issued shall be part of the Tender Documents and shall be communicated in writing to all who have obtained the Tender Documents from the Procuring Entity. The Procuring Entity shall also promptly publish the addendum on the Procuring Entity's website in accordance with ITT 7.5.
- 83** To give Tenderers reasonable time in which to take an addendum into account in preparing their Tenders, the Procuring Entity should extend the dead line for the submission of Tenders, pursuant to ITT 22.2.

C. PREPARATION OF TENDERS

9.0 Cost of Tendering

The Tenderer shall bear all costs associated with the preparation and submission of its Tender, and the Procuring Entity shall not be responsible or liable for those costs, regardless of the conduct or outcome of the tendering process.

10.0 Language of Tender

The Tender, as well as all correspondence and documents relating to the tender exchanged by the tenderer and the Procuring Entity, shall be written in the English Language. Supporting documents and printed literature that are part of the Tender may be in another language provided they are accompanied by an accurate and notarized translation of the relevant passages into the English Language, in which case, for purposes of interpretation of the Tender, such translation shall govern.

11.0 Documents Comprising the Tender

- 11.1** The Tender shall comprise the following:
- a) Form of Tender prepared in accordance with ITT 12;
 - b) Schedules including priced Bill of Quantities, completed in accordance with ITT 12 and ITT 14;
 - c) Tender Security or Tender-Securing Declaration, in accordance with ITT 19.1;
 - d) Alternative Tender, if permissible, in accordance with ITT 13;
 - e) **Authorization**: written confirmation authorizing the signatory of the Tender to commit the Tenderer, in accordance with ITT 20.3;
 - f) **Qualifications**: documentary evidence in accordance with ITT 17 establishing the Tenderer's qualifications to perform the Contract if its Tender is accepted;
 - g) **Conformity**: a technical proposal in accordance with ITT 16;
 - h) Any other document required in the **TDS**.
- 11.2** In addition to the requirements under ITT 11.1, Tenders submitted by a JV shall include a copy of the Joint Venture Agreement entered into by all members. Alternatively, a letter of intent to execute a Joint Venture Agreement in the event of a successful Tender shall be signed by all members and submitted with the Tender, together with a copy of the proposed JV Agreement. Change of membership and conditions of the JV prior to contract signature will render the tenderer liable for disqualification.

12.0 Form of Tender and Schedules

- 12.1 The Form of Tender and Schedules, including the Bill of Quantities, shall be prepared using the relevant forms furnished in Section IV, Tendering Forms. The forms must be completed with out any alterations to the text, and no substitutes shall be accepted except as provided under ITT 20.3. All blank spaces shall be filled in with the information requested. The Tenderer shall chronologically serialize all pages of the tender documents submitted.
- 12.2 The Tenderer shall furnish in the Form of Tender information on commissions and gratuities, if any, paid or to be paid to agents or any other party relating to this Tender.

13 Alternative Tenders

- 13.1 Unless otherwise specified in the TDS, alternative Tenders shall not be considered.
- 13.2 When alternative times for completion are explicitly invited, a statement to that effect will be included in the **TDS**, and the method of evaluating different alternative times for completion will be described in Section III, Evaluation and Qualification Criteria.
- 13.3 Except as provided under ITT 13.4 below, Tenderers wishing to offer technical alternatives to the requirements of the Tender Documents must first price the Procuring Entity's design as described in the Tender Documents and shall further provide all information necessary for a complete evaluation of the alternative by the Procuring Entity, including drawings, design calculations, technical specifications, breakdown of prices, and proposed construction methodology and other relevant details. Only the technical alternatives, if any, of the Tenderer with the Winning Tender conforming to the basic technical requirements shall be considered by the Procuring Entity.
- 13.4 When specified in the **TDS**, Tenderers are permitted to submit alternative technical solutions for specified parts of the Works, and such parts will be identified in the **TDS**, as will the method for their evaluating, and described in Section VII, Works' Requirements.

140 Tender Prices and Discounts

- 141 The prices and discounts (including any price reduction) quoted by the Tenderer in the Form of Tender and in the Bill of Quantities shall conform to the requirements specified below.
- 142 The Tenderer shall fill in rates and prices for all items of the Works described in the Bill of Quantities. Items against which no rate or price is entered by the Tenderer shall be deemed covered by the rates for other items in the Bill of Quantities and will not be paid for separately by the Procuring Entity. An item not listed in the priced Bill of Quantities shall be assumed to be not included in the Tender, and provided that the Tender is determined substantially responsive notwithstanding this omission, the average price of the item quoted by substantially responsive Tenderers will be added to the Tender price and the equivalent total cost of the Tender so determined will be used for price comparison.
- 143 The price to be quoted in the Form of Tender, in accordance with ITT 12.1, shall be the total price of the Tender, including any discounts offered.
- 144 The Tenderer shall quote any discounts and the methodology for their application in the Form of Tender, in accordance with ITT 12.1.
- 145 It will be specified in the **TDS** if the rates and prices quoted by the Tenderer are or are not subject to adjustment during the performance of the Contract in accordance with the provisions of the Conditions of Contract, except incases where the contract is subject to fluctuations and adjustments, not fixed price. In such a case, the Tenderer shall furnish the indices and weightings for the price adjustment formulae in the Schedule of Adjustment Data and the Procuring Entity may require the Tenderer to justify its proposed indices and weightings.
- 146 Where tenders are being invited for individual lots (contracts) or for any combination of lots (packages), tenderers wishing to offer discounts for the award of more than one Contract shall specify in their Tender the price reductions applicable to each package, or alternatively, to individual Contracts within the package. Discounts shall be submitted in accordance with ITT 14.4, provided the Tenders for all lots (contracts) are opened at the sametime.

147 All duties, taxes, and other levies payable by the Contractor under the Contract, or for any other cause, as of the date 30 days prior to the deadline for submission of Tenders, shall be included in the rates and prices and the total Tender Price submitted by the Tenderer.

150 Currencies of Tender and Payment

151 The currency (ies) of the Tender and the currency (ies) of payments shall be the same.

152 Tenderers shall quote entirely in Kenya Shillings. The unit rates and the prices shall be quoted by the Tenderer in the Bill of Quantities, entirely in Kenya shillings.

a) A Tenderer expecting to incur expenditures in other currencies for inputs to the Works supplied from outside Kenya (referred to as “the foreign currency requirements”) shall (if so allowed in the **TDS**) indicate in the Appendix to Tender the percentage(s) of the Tender Price (excluding Provisional Sums), needed by the Tenderer for the payment of such foreign currency requirements, limited to no more than two foreign currencies.

b) The rates of exchange to be used by the Tenderer in arriving at the local currency equivalent and the percentage(s) mentioned in (a) above shall be specified by the Tenderer in the Appendix to Tender and shall be based on the exchange rate provided by the Central Bank of Kenya on the date 30 days prior to the actual date of tender opening. Such exchange rate shall apply for all foreign payments under the Contract.

153 Tenderers may be required by the Procuring Entity to justify, to the Procuring Entity's satisfaction, their local and foreign currency requirements, and to substantiate that the amounts included in the unit rates and prices and shown in the Schedule of Adjustment Data in the Appendix to Tender are reasonable, in which case a detailed break down of the foreign currency requirements shall be provided by Tenderers.

16.0 Documents Comprising the Technical Proposal

The Tenderer shall furnish a technical proposal including a statement of work methods, equipment, personnel, schedule and any other information as stipulated in Section IV, Tender Forms, and in sufficient detail to demonstrate the adequacy of the Tenderer's proposal to meet the work's requirements and the completion time.

170 Documents Establishing the Eligibility and Qualifications of the Tenderer

171 Tenderers shall complete the Form of Tender, included in Section IV, Tender Forms, to establish Tenderer's eligibility in accordance with ITT 4.

172 In accordance with Section III, Evaluation and Qualification Criteria, to establish its qualifications to perform the Contract the Tenderer shall provide the information requested in the corresponding information sheets included in Section IV, Tender Forms.

173 If a margin of preference applies as specified in accordance with ITT 33.1, national tenderers, individually or in joint ventures, applying for eligibility for national preference shall supply all information required to satisfy the criteria for eligibility specified in accordance with ITT 33.1.

174 Tenderers shall be asked to provide, as part of the data for qualification, such information, including details of ownership, as shall be required to determine whether, according to the classification established by the Procuring Entity, a particular contractor or group of contractors qualifies for a margin of preference. Further the information will enable the Procuring Entity identify any actual or potential conflict of interest in relation to the procurement and/or contract management processes, or a possibility of collusion between tenderers, and thereby help to prevent any corrupt influence in relation to the procurement process or contract management.

175 The purpose of the information described in **ITT 17.4** above overrides any claims to confidentiality which a tenderer may have. There can be no circumstances in which it would be justified for a tenderer to keep information relating to its ownership and control confidential where it is tendering to undertake public sector work and receive public sector funds. Thus, confidentiality will not be accepted by the Procuring Entity as a justification for a Tenderer's failure to disclose, or failure to provide required information on its ownership and control.

176 The Tenderer shall provide further documentary proof, information or authorizations that the Procuring Entity may request in relation to ownership and control which information on any changes to the information which was provided by the tenderer under ITT 6.4. The obligations to require this information shall continue for the duration of the procurement process and contract performance and after completion of the contract, if any change to the information previously provided may reveal a conflict of interest in relation to the award or management of the contract.

- 177** All information provided by the tenderer pursuant to these requirements must be complete, current and accurate as at the date of provision to the Procuring Entity. In submitting the information required pursuant to these requirements, the Tenderer shall warrant that the information submitted is complete, current and accurate as at the date of submission to the Procuring Entity.
- 178** If a tenderer fails to submit the information required by these requirements, its tender will be rejected. Similarly, if the Procuring Entity is unable, after taking reasonable steps, to verify to a reasonable degree the information submitted by a tenderer pursuant to these requirements, then the tender will be rejected.
- 179** If information submitted by a tenderer pursuant to these requirements, or obtained by the Procuring Entity (whether through its own enquiries, through notification by the public or otherwise), shows any conflict of interest which could materially and improperly benefit the tenderer in relation to the procurement or contract management process, then:
- i) If the procurement process is still ongoing, the tenderer will be disqualified from the procurement process,
 - ii) if the contract has been awarded to that tenderer, the contract award will be set aside pending the outcome of (iii),
 - iii) the tenderer will be referred to the relevant law enforcement authorities for investigation of whether the tenderer or any other person have committed any criminal offence.
- 17.10** If a tenderer submits information pursuant to these requirements that is incomplete, inaccurate or out-of-date, or attempts to obstruct the verification process, then the consequences ITT 17.8 will ensue unless the tenderer can show to the reasonable satisfaction of the Procuring Entity that any such act was not material, or was due to genuine error which was not attributable to the intentional act, negligence or recklessness of the tenderer.

18.0 Period of Validity of Tenders

- 18.1.** Tenders shall remain valid for the Tender Validity period specified in the **TDS**. The Tender Validity period starts from the date fixed for the Tender submission deadline (as prescribed by the Procuring Entity in accordance with ITT 22). A tender valid for a shorter period shall be rejected by the Procuring Entity as non-responsive.
- 18.2** In exceptional circumstances, prior to the expiration of the Tender validity period, the Procuring Entity may request Tenderers to extend the period of validity of their Tenders. The request and the responses shall be made in writing. If a Tender Security is requested in accordance with ITT 19, it shall also be extended for thirty (30) days beyond the deadline of the extended validity period. A Tenderer may refuse the request without forfeiting its Tender security. A Tenderer granting the request shall not be required or permitted to modify its Tender.

19.0 Tender Security

- 191** The Tenderer shall furnish as part of its Tender, either a Tender-Securing Declaration or a Tender Security as specified in the **TDS**, in original form and, in the case of a Tender Security, in the amount and currency **specified** in the **TDS**. A Tender-Securing Declaration shall use the form included in Section IV, Tender Forms.
- 192** If a Tender Security is specified pursuant to ITT 19.1, the Tender Security shall be a demand guarantee in any of the following forms at the Tenderer's option:
- i) cash;
 - ii) a bank guarantee;
 - iii) a guarantee by an insurance company registered and licensed by the Insurance Regulatory Authority listed by the Authority;
 - (iv) a guarantee issued by a financial institution approved and licensed by the Central Bank of Kenya, from a reputable source, and an eligible country.
- 193** If an unconditional bank guarantee is issued by a bank located outside Kenya, the issuing bank shall have a correspondent bank located in Kenya to make it enforceable. The Tender Security shall be valid for thirty (30) days beyond the original validity period of the Tender, or beyond any period of extension if requested under ITT 18.2.

- 194** If a Tender Security or Tender-Securing Declaration is specified pursuant to ITT 19.1, any Tender not accompanied by a substantially responsive Tender Security or Tender-Securing Declaration shall be rejected by the Procuring Entity as non-responsive.
- 195** If a Tender Security is specified pursuant to ITT 19.1, the Tender Security of unsuccessful Tenderers shall be returned as promptly as possible upon the successful Tenderer's signing the Contract and furnishing the Performance Security and any other documents required in the TDS. The Procuring Entity shall also promptly return the tender security to the tenderers where the procurement proceedings are terminated, all tenders were determined non-responsive or a bidder declines to extend tender validity period.
- 196** The Tender Security of the successful Tenderer shall be returned as promptly as possible once the successful Tenderer has signed the Contract and furnished the required Performance Security, and any other documents required in the TDS.
- 197** The Tender Security may be forfeited or the Tender-Securing Declaration executed:
- a) if a Tenderer withdraws its Tender during the period of Tender validity specified by the Tenderer on the Form of Tender, or any extension there to provided by the Tenderer; or
 - b) if the successful Tenderer fails to:
 - i) sign the Contract in accordance with ITT47; or
 - ii) furnish a Performance Security and if required in the TDS, and any other documents required in the TDS.
- 198** Where tender securing declaration is executed, the Procuring Entity shall recommend to the PPRA to debar the Tenderer from participating in public procurement as provided in the law.
- 199** The Tender Security or the Tender-Securing Declaration of a JV shall be in the name of the JV that submits the Tender. If the JV has not been legally constituted into a legally enforceable JV at the time of tendering, the Tender Security or the Tender-Securing Declaration shall be in the names of all future members as named in the letter of intent referred to in ITT 4.1 and ITT 11.2.
- 19.10** A tenderer shall not issue a tender security to guarantee itself.
- 200** **Format and Signing of Tender**
- 201** The Tenderer shall prepare one original of the documents comprising the Tender as described in ITT 11 and clearly mark it "ORIGINAL." Alternative Tenders, if permitted in accordance with ITT 13, shall be clearly marked "ALTERNATIVE." In addition, the Tenderer shall submit copies of the Tender, in the number specified in the TDS and clearly mark them "COPY." In the event of any discrepancy between the original and the copies, the original shall prevail.
- 202** Tenderers shall mark as "CONFIDENTIAL" all information in their Tenders which is confidential to their business. This may include proprietary information, trade secrets, or commercial or financially sensitive information.
- 203** The original and all copies of the Tender shall be typed or written in indelible ink and shall be signed by a person duly authorized to sign on behalf of the Tenderer. This authorization shall consist of a written confirmation as specified in the TDS and shall be attached to the Tender. The name and position held by each person signing the authorization must be typed or printed below the signature. All pages of the Tender where entries or amendments have been made shall be signed or initialed by the person signing the Tender.
- 204** In case the Tenderer is a JV, the Tender shall be signed by an authorized representative of the JV on behalf of the JV, and so as to be legally binding on all the members as evidenced by a power of attorney signed by their legally authorized representatives.
- 205** Any inter-lineation, erasures, or overwriting shall be valid only if they are signed or initialed by the person signing the Tender.

D. SUBMISSION AND OPENING OF TENDERS

210 Sealing and Marking of Tenders

211 The Tenderer shall deliver the Tender in a single sealed envelope, or in a single sealed package, or in a single sealed container bearing the name and Reference number of the Tender, addressed to the Procuring Entity and a warning not to open before the time and date for Tender opening date. Within the single envelope, package or container, the Tenderer shall place the following separate, sealed envelopes:

- a) in an envelope or package or container marked “ORIGINAL”, all documents comprising the Tender, as described in ITT 11; and
- b) in a nvelope or package or container marked “COPIES”, all required copies of the Tender; and
- c) if alternative Tenders are permitted in accordance with ITT 13, and if relevant:
 - i) in an envelope or package or container marked “ORIGINAL –ALTERNATIVE TENDER”, the alternative Tender; and
 - ii) in the envelope or package or container marked “COPIES- ALTERNATIVE TENDER”, all required copies of the alternative Tender.

The inner envelopes or packages or containers shall:

- a) bear the name and address of the Procuring Entity,
- b) bear the name and address of the Tenderer; and
- c) bear the name and Reference number of the Tender.

212 If an envelope or package or container is not sealed and marked as required, the *Procuring Entity* will assume no responsibility for the misplacement or premature opening of the Tender. Tenders misplaced or opened prematurely will not be accepted.

220 Deadline for Submission of Tenders

221 Tenders must be received by the Procuring Entity at the address specified in the **TDS** and no later than the date and time also specified in the **TDS**. When so specified in the **TDS**, tenderers shall have the option of submitting their Tenders electronically. Tenderers submitting Tenders electronically shall follow the electronic Tender submission procedures specified in the **TDS**.

222 The Procuring Entity may, at its discretion, extend the deadline for the submission of Tenders by amending the Tender Documents in accordance with ITT 8, in which case all rights and obligations of the Procuring Entity and Tenderers previously subject to the deadline shall there after be subject to the deadline as extended.

23.0 Late Tenders

The Procuring Entity shall not consider any Tender that arrives after the deadline for submission of tenders, in accordance with ITT 22. Any Tender received by the Procuring Entity after the deadline for submission of Tenders shall be declared late, rejected, and returned unopened to the Tenderer.

240 Withdrawal, Substitution, and Modification of Tenders

241 A Tenderer may withdraw, substitute, or modify its Tender after it has been submitted by sending a written notice, duly signed by an authorized representative, and shall include a copy of the authorization in accordance with ITT 20.3, (except that withdrawal notices do not require copies). The corresponding substitution or modification of the Tender must accompany the respective written notice. All notices must be:

- a) prepared and submitted in accordance with ITT 20 and ITT 21 (except that withdrawal notices do not require copies), and in addition, the respective envelopes shall be clearly marked “WITHDRAWAL,” “SUBSTITUTION,” “MODIFICATION;” and
- b) received by the Procuring Entity prior to the deadline prescribed for submission of Tenders, in accordance with ITT 22.

242 Tenders requested to be withdrawn in accordance with ITT 24.1 shall be returned unopened to the Tenderers.

243 No Tender may be withdrawn, substituted, or modified in the interval between the deadline for submission of Tenders and the expiration of the period of Tender validity specified by the Tenderer on the Form of Tender or any extension thereof.

25. Tender Opening

- 251** Except in the cases specified in ITT 23 and ITT 24.2, the Procuring Entity shall publicly open and read out all Tenders received by the deadline, at the date, time and place specified **in the TDS**, in the presence of Tenderers' designated representatives who chooses to attend. Any specific electronic Tender opening procedures required if electronic Tendering is permitted in accordance with ITT 22.1, shall be as specified in the **TDS**.
- 252** First, envelopes marked "WITHDRAWAL" shall be opened and read out and the envelopes with the corresponding Tender shall not be opened but returned to the Tenderer. No Tender withdrawal shall be permitted unless the corresponding withdrawal notice contains a valid authorization to request the withdrawal and is read out at Tender opening.
- 253** Next, envelopes marked "SUBSTITUTION" shall be opened and read out and exchanged with the corresponding Tender being substituted, and the substituted Tender shall not be opened, but returned to the Tenderer. No Tender substitution shall be permitted unless the corresponding substitution notice contains a valid authorization to request the substitution and is read out at Tender opening.
- 254** Next, envelopes marked "MODIFICATION" shall be opened and read out with the corresponding Tender. No Tender modification shall be permitted unless the corresponding modification notice contains a valid authorization to request the modification and is read out at Tender opening.
- 255** Next, all remaining envelopes shall be opened one at a time, reading out: the name of the Tenderer and whether there is a modification; the total Tender Price, per lot (contract) if applicable, including any discounts and alternative Tenders; the presence or absence of a Tender Security or Tender-Securing Declaration, if required; and any other details as the Procuring Entity may consider appropriate.
- 256** Only Tenders, alternative Tenders and discounts that are opened and read out at Tender opening shall be considered further for evaluation. The Form of Tender and pages of the Bill of Quantities (to be decided on by the tender opening committee) are to be initialed by the members of the tender opening committee attending the opening.
- 257** At the Tender Opening, the Procuring Entity shall neither discuss the merits of any Tender nor reject any Tender (except for late Tenders, in accordance with ITT 23.1).
- 258** The Procuring Entity shall prepare minutes of the Tender Opening that shall include, as a minimum: -
- a) the name of the Tenderer and whether there is a withdrawal, substitution, or modification;
 - b) the Tender Price, per lot (contract) if applicable, including any discounts;
 - c) any alternative Tenders;
 - d) the presence or absence of a Tender Security, if new as required;
 - e) number of pages of each tender document submitted.
- 259** The Tenderers' representatives who are present shall be requested to sign the minutes. The omission of a Tenderer's signature on the minutes shall not invalidate the contents and effect of the minutes. A copy of the tender opening register shall be distributed to all Tenderers.

E. EVALUATION AND COMPARISON OF TENDERS

26. Confidentiality

- 261** Information relating to the evaluation of Tenders and recommendation of contract award shall not be disclosed to Tenderers or any other persons not officially concerned with the Tender process until information on Intention to Award the Contract is transmitted to all Tenderers in accordance with ITT 43.
- 262** Any effort by a Tenderer to influence the Procuring Entity in the evaluation of the Tenders or Contract award decisions may result in the rejection of its tender.
- 263** Notwithstanding ITT 26.2, from the time of tender opening to the time of contract award, if a tenderer wishes to contact the Procuring Entity on any matter related to the tendering process, it shall do so in writing.

27.0 Clarification of Tenders

27.1 To assist in the examination, evaluation, and comparison of the tenders, and qualification of the tenderers, the Procuring Entity may, at its discretion, ask any tenderer for a clarification of its tender, given a reasonable time for a response. Any clarification submitted by a tenderer that is not in response to a request by the Procuring Entity shall not be considered. The Procuring Entity's request for clarification and the response shall be in writing. No change, including any voluntary increase or decrease, in the prices or substance of the tender shall be sought, offered, or permitted, except to confirm the correction of arithmetic errors discovered by the Procuring Entity in the evaluation of the tenders, in accordance with ITT 31.

27.2 If a tenderer does not provide clarifications of its tender by the date and time set in the Procuring Entity's request for clarification, its Tender may be rejected.

28.0 Deviations, Reservations, and Omissions

28.1 During the evaluation of tenders, the following definitions apply: -

- a) "*Deviation*" is a departure from the requirements specified in the tender document;
- b) "*Reservation*" is the setting of limiting conditions or withholding from complete acceptance of the requirements specified in the tender document; and
- c) "*Omission*" is the failure to submit part or all of the information or documentation required in the Tender document.

29.0 Determination of Responsiveness

29.1 The Procuring Entity's determination of a Tender's responsiveness is to be based on the contents of the tender itself, as defined in ITT 11.

29.2 A substantially responsive Tender is one that meets the requirements of the Tender document without material deviation, reservation, or omission. A material deviation, reservation, or omission is one that, if accepted, would:

- a) Affect in any substantial way the scope, quality, or performance of the Works specified in the Contract;
- b) limit in any substantial way, inconsistent with the tender document, the Procuring Entity's rights or the tenderer's obligations under the proposed contract;
- c) if rectified, would unfairly affect the competitive position of other tenderers presenting substantially responsive tenders.

29.3 The Procuring Entity shall examine the technical aspects of the tender submitted in accordance with ITT 16, to confirm that all requirements of Section VII, Works' Requirements have been met without any material deviation, reservation or omission.

29.4 If a tender is not substantially responsive to the requirements of the tender document, it shall be rejected by the Procuring Entity and may not subsequently be made responsive by correction of the material deviation, reservation, or omission.

30.0 Non-material Non-conformities

30.1 Provided that a tender is substantially responsive, the Procuring Entity may waive any non-conformities in the tender.

30.2 Provided that a Tender is substantially responsive, the Procuring Entity may request that the tenderer submit the necessary information or documentation, within a reasonable period of time, to rectify non-material non-conformities in the tender related to documentation requirements. Requesting information or documentation on such non-conformities shall not be related to any aspect of the price of the tender. Failure of the tenderer to comply with the request may result in the rejection of its tender.

30.3 Provided that a tender is substantially responsive, the Procuring Entity shall rectify quantifiable non-material non-conformities related to the Tender Price. To this effect, the Tender Price shall be adjusted, for comparison purposes only, to reflect the price of a missing or non-conforming item or component in the manner specified in the TDS.

31.0 Arithmetical Errors

31.1 The tender sum as submitted and read out during the tender opening shall be absolute and final and shall not be the subject of correction, adjustment or amendment in any way by any person or entity.

31.2 Provided that the Tender is substantially responsive, the Procuring Entity shall handle errors on the following basis: -

- a) Any error detected if considered a major deviation that affects the substance of the tender, shall lead to disqualification of the tender as non-responsive.
- b) Any errors in the submitted tender arising from a miscalculation of unit price, quantity, subtotal and total bid prices shall be considered as a major deviation that affects the substance of the tender and shall lead to disqualification of the tender as non-responsive. and
- c) if there is a discrepancy between words and figures, the amount in words shall prevail

31.3 Tenderers shall be notified of any error detected in their bid during the notification of award.

32.0 Conversion to Single Currency

For evaluation and comparison purposes, the currency (ies) of the Tender shall be converted into a single currency as specified in the **TDS**.

33.0 Margin of Preference and Reservations

33.1 A margin of preference may be allowed only when the contract is open to international competitive tendering where foreign contractors are expected to participate in the tendering process and where the contract exceeds the value/threshold specified in the Regulations.

33.2 A margin of preference shall not be allowed unless it is specified so in the **TDS**.

33.3 Contracts procured on basis of international competitive tendering shall not be subject to reservations exclusive to specific groups as provided in ITT 33.4.

33.4 Where it is intended to reserve a contract to a specific group of businesses (these groups are Small and Medium Enterprises, Women Enterprises, Youth Enterprises and Enterprises of persons living with disability, as the case may be), and who are appropriately registered as such by the authority to be specified in the **TDS**, a procuring entity shall ensure that the invitation to tender specifically indicates that only businesses or firms belonging to the specified group are eligible to tender. No tender shall be reserved to more than one group. If not so stated in the Invitation to Tender and in the Tender documents, the invitation to tender will be open to all interested tenderers.

34.0 Nominated Subcontractors

34.1 Unless otherwise stated in the **TDS**, the Procuring Entity does not intend to execute any specific elements of the Works by subcontractors selected/nominated by the Procuring Entity. In case the Procuring Entity nominates a subcontractor, the subcontract agreement shall be signed by the Subcontractor and the Procuring Entity. The main contract shall specify the working arrangements between the main contractor and the nominated subcontractor.

34.2 Tenderers may propose sub-contracting up to the percentage of total value of contracts or the volume of works as specified in the **TDS**. Subcontractors proposed by the Tenderer shall be fully qualified for their parts of the Works.

34.3 Domestic subcontractor's qualifications shall not be used by the Tenderer to qualify for the Works unless their specialized parts of the Works were previously designated so by the Procuring Entity in the **TDS** as can be met by subcontractors referred to hereafter as 'Specialized Subcontractors', in which case, the qualifications of the Specialized Subcontractors proposed by the Tenderer may be added to the qualifications of the Tenderer.

35. Evaluation of Tenders

35.1 The Procuring Entity shall use the criteria and methodologies listed in this ITT and Section III, Evaluation and Qualification Criteria. No other evaluation criteria or methodologies shall be permitted. By applying the criteria and methodologies the Procuring Entity shall determine the Lowest Evaluated Tender in accordance with ITT 40.

- 352 To evaluate a Tender, the Procuring Entity shall consider the following:
- a) Price adjustment in accordance with ITT 31.1 (iii); excluding provisional sums and contingencies, if any, but including Daywork items, where priced competitively;
 - b) price adjustment due to discounts offered in accordance with ITT 14.4;
 - c) converting the amount resulting from applying (a) and (b) above, if relevant, to a single currency in accordance with ITT 32;
 - d) price adjustment due to quantifiable non material non-conformities in accordance with ITT 30.3; and
 - e) any additional evaluation factors specified in the **TDS** and Section III, Evaluation and Qualification Criteria.
- 353 The estimated effect of the price adjustment provisions of the Conditions of Contract, applied over the period of execution of the Contract, shall not be considered in Tender evaluation.
- 354 Where the tender involves multiple lots or contracts, the tenderer will be allowed to tender for one or more lots (contracts). Each lot or contract will be evaluated in accordance with ITT 35.2. The methodology to determine the lowest evaluated tenderer or tenderers base done lot (contract) or based on a combination of lots (contracts), will be specified in Section III, Evaluation and Qualification Criteria. In the case of multiple lots or contracts, tenderer will be will be required to prepare the Eligibility and Qualification Criteria Form for each Lot.

36.0 Comparison of tenders

The Procuring Entity shall compare the evaluated costs of all substantially responsive Tenders established in accordance with ITT 35.2 to determine the Tender that has the lowest evaluated cost.

37.0 Abnormally low tenders and abnormally high tenders

Abnormally Low Tenders

- 371 An Abnormally Low Tender is one where the Tender price, in combination with other elements of the Tender, appears so low that it raises material concerns as to the capability of the Tenderer in regards to the Tenderer's ability to perform the Contract for the offered Tender Price or that genuine competition between Tenderers is compromised.
- 372 In the event of identification of a potentially Abnormally Low Tender, the Procuring Entity shall seek written clarifications from the Tenderer, including detailed price analyses of its Tender price in relation to the subject matter of the contract, scope, proposed methodology, schedule, allocation of risks and responsibilities and any other requirements of the Tender document.
- 373 After evaluation of the price analyses, in the event that the Procuring Entity determines that the Tenderer has failed to demonstrate its capability to perform the Contract for the offered Tender Price, the Procuring Entity shall reject the Tender.

Abnormally high tenders

- 374 An abnormally high tender price is one where the tender price, in combination with other constituent elements of the Tender, appears unreasonably too high to the extent that the Procuring Entity is concerned that it (the Procuring Entity) may not be getting value for money or it may be paying too high a price for the contract compared with market prices or that genuine competition between Tenderers is compromised.
- 375 In case of a normally high price, the Procuring Entity shall make a survey of the market prices, check if the estimated cost of the contract is correct and review the Tender Documents to check if the specifications, scope of work and conditions of contract are contributory to the abnormally high tenders. The Procuring Entity may also seek written clarification from the tenderer on the reason for the high tender price. The Procuring Entity shall proceed as follows:
- i) If the tender price is abnormally high based on wrong estimated cost of the contract, the Procuring Entity may accept or not accept the tender depending on the Procuring Entity's budget considerations.
 - ii) If specifications, scope of work and/or conditions of contract are contributory to the abnormally high tender prices, the Procuring Entity shall reject all tenders and may retender for the contract based on revised estimates, specifications, scope of work and conditions of contract, as the case may be.

376 If the Procuring Entity determines that the Tender Price is abnormally too high because genuine competition between tenderers is compromised (*often due to collusion, corruption or other manipulations*), the Procuring Entity shall reject all Tenders and shall institute or cause competent Government Agencies to institute an investigation on the cause of the compromise, before retendering.

380 Unbalanced and/ or front-loaded tenders

381 If in the Procuring Entity's opinion, the Tender that is evaluated as the lowest evaluated price is seriously unbalanced and/or frontloaded, the Procuring Entity may require the Tenderer to provide written clarifications. Clarifications may include detailed price analyses to demonstrate the consistency of the tender prices with the scope of works, proposed methodology, schedule and any other requirements of the Tender document.

382 After the evaluation of the information and detailed price analyses presented by the Tenderer, the Procuring Entity may as appropriate:

- a) accept the Tender;
- b) require that the total amount of the Performance Security be increased at the expense of the Tenderer to a level not exceeding a 30% of the Contract Price;
- c) agree on a payment mode that eliminates the inherent risk of the Procuring Entity paying too much for undelivered works;
- d) reject the Tender,

390 Qualifications of the tenderer

391 The Procuring Entity shall determine to its satisfaction whether the eligible Tenderer that is selected as having submitted the lowest evaluated cost and substantially responsive Tender, meets the qualifying criteria specified in Section III, Evaluation and Qualification Criteria.

392 The determination shall be based upon an examination of the documentary evidence of the Tenderer's qualifications submitted by the Tenderer, pursuant to ITT 17. The determination shall not take into consideration the qualifications of other firms such as the Tenderer's subsidiaries, parent entities, affiliates, subcontractors (other than Specialized Sub-contractors if permitted in the Tender document), or any other firm(s) different from the Tenderer.

393 An affirmative determination shall be a prerequisite for award of the Contract to the Tenderer. A negative determination shall result in disqualification of the Tender, in which event the Procuring Entity shall proceed to the Tenderer who offers a substantially responsive Tender with the next lowest evaluated price to make a similar determination of that Tenderer's qualifications to perform satisfactorily.

400 Lowest evaluated tender

Having compared the evaluated prices of Tenders, the Procuring Entity shall determine the Lowest Evaluated Tender. The Lowest Evaluated Tender is the Tender of the Tenderer that meets the Qualification Criteria and whose Tender has been determined to be:

- a) Most responsive to the Tender document; and
- b) the lowest evaluated price.

41.0 Procuring entity's right to accept any tender, and to reject any or all tenders.

The Procuring Entity reserves the right to accept or reject any Tender and to annul the Tender process and reject all Tenders at any time prior to Contract Award, without there by incurring any liability to Tenderers. In case of annulment, all Tenders submitted and specifically, Tender securities, shall be promptly returned to the Tenderers.

F. AWARD OF CONTRACT

42.0 Award criteria

The Procuring Entity shall award the Contract to the successful tenderer whose tender has been determined to be the Lowest Evaluated Tender.

430 Notice of Intention to Enter into a Contract/Notification of Award

Upon award of the contract and Prior to the expiry of the Tender Validity Period the Procuring Entity shall issue a Notification of Intention to Enter into a Contract/Notification of award to all tenderers which shall contain, at a minimum, the following information:

- a) the name and address of the Tenderer submitting the successful tender;
- b) the Contract price of the successful tender;
- c) a statement of the reason(s) the tender of the unsuccessful tenderer to whom the letter is addressed was unsuccessful, unless the price information in (c) above already reveals the reason;
- d) the expiry date of the Standstill Period; and
- e) instruction son how to request a debriefing and/ or submit a complaint during the stand still period;

440 Stand still Period

441 The Contract shall not be signed earlier than the expiry of a Standstill Period of 14 days to allow any dissatisfied tender to launch a complaint. Where only one Tender is submitted, the Standstill Period shall not apply.

442 Where a Standstill Period applies, it shall commence when the Procuring Entity has transmitted to each Tenderer the Notification of Intention to Enter into a Contract with the successful Tenderer.

450 Debriefing by The Procuring Entity

451 On receipt of the Procuring Entity's Notification of Intention to Enter into a Contract referred to in ITT 43, an unsuccessful tenderer may make a written request to the Procuring Entity for a debriefing on specific issues or concerns regarding their tender. The Procuring Entity shall provide the debriefing within five days of receipt of the request.

452 Debriefings of unsuccessful Tenderers may be done in writing or verbally. The Tenderer shall bear its own costs of attending such a debriefing meeting.

46.0 Letter of Award

Prior to the expiry of the Tender Validity Period and upon expiry of the Standstill Period specified in ITT 42.1, upon addressing a complaint that has been filed with in the Standstill Period, the Procuring Entity shall transmit the Letter of Award to the successful Tenderer. The letter of award shall request the successful tenderer to furnish the Performance Security within 21 days of the date of the letter.

470 Signing of Contract

471 Upon the expiry of the fourteen days of the Notification of Intention to enter in to contract and upon the parties meeting their respective statutory requirements, the Procuring Entity shall send the successful Tenderer the Contract Agreement.

472 Within fourteen (14) days of receipt of the Contract Agreement, the successful Tenderer shall sign, date, and return it to the Procuring Entity.

473 The written contract shall be entered into within the period specified in the notification of award and before expiry of the tender validity period.

48.0 Performance Security

481 Within twenty-one (21) days of the receipt of the Letter of Award from the Procuring Entity, the successful Tenderer shall furnish the Performance Security and, any other documents required in the **TDS**, in accordance with the General Conditions of Contract, subject to ITT 38.2 (b), using the Performance Security and other Forms included in Section X, Contract Forms, or another form acceptable to the Procuring Entity. A foreign institution providing a bank guarantee shall have a correspondent financial institution located in Kenya, unless the Procuring Entity has agreed in writing that a correspondent bank is not required.

482 Failure of the successful Tenderer to submit the above-mentioned Performance Security and other documents required in the **TDS** or sign the Contract shall constitute sufficient grounds for the annulment of the award and forfeiture of the Tender Security. In that event the Procuring Entity may award the Contract to the Tenderer offering the next Best Evaluated Tender.

483 Performance security shall not be required for contracts estimated to cost less than the amount specified in the Regulations.

490 Publication of Procurement Contract

Within fourteen days after signing the contract, the Procuring Entity shall publish the awarded contract at its notice boards and websites; and on the Website of the Authority. At the minimum, the notice shall contain the following information:

- a) name and address of the Procuring Entity;
- b) name and reference number of the contract being awarded, a summary of its scope and the selection method used;
- c) the name of the successful Tenderer, the final total contract price, the contract duration;
- d) dates of signature, commencement and completion of contract;
- e) names of all Tenderers that submitted Tenders, and their Tender prices as readout at Tender opening.

50.0 Procurement related Complaint

The procedures for making Procurement-related Complaints are as specified in the **TDS**.

SECTION II - TENDER DATA SHEET

The following specific data shall complement, supplement, or amend the provisions in the Instruction to Tenderers (ITT). Whenever there is a conflict, the conditions hererin shall prevail over those in ITT

A. GENERAL	
ITT 1.1	<p>The name of the Contract is: PROPOSED CONSTRUCTION OF ADMINISTRATION AND TUITION COMPLEX – PHASE 1 AT KARUMO TECHNICAL TRAINING INSTITUTE - MERU COUNTY</p> <p>The reference number of the contract is: <u><i>as indicated in the tender advertisement</i></u></p> <p>The number and identification of Lots (contracts) comprising this tender are: <i>Not applicable</i></p> <p>Lot 1 Name: _____</p> <p>Lot 2 Name: _____</p> <p>Lot...Name: _____</p>
ITT 2.4	<p>The information made available on competing firms is as follows: <i>As contained in this tender document.</i></p>
ITT 2.4	<p>The firms that provided consultancy services for the contract being tendered for are: REGIONAL WORKS OFFICE – EASTERN REGION, P.O.BOX 455-60100 EMBU</p>
ITT 3.1	<p>The maximum number of members in a Joint Venture (JV) shall be: <i>Not more than two (2)</i></p>

B. Contents of Tender Document	
ITT 7.1	<p>(i) The Tenderer will submit any request for clarifications in writing at the Address: <i>As indicated in the tender advertisement</i></p> <p>To reach the Procuring Entity not later than <u><i>as indicated in the tender advertisement</i></u></p> <p>(ii) The Procuring Entity shall publish its response at the website <u><i>as indicated in the tender advertisement</i></u></p>
ITT 7.2	<p>(A) A pre-arranged pretender site visit <i>shall</i> take place <u><i>as below</i></u></p> <p>Date: 30th May, 2024 Time: 10.00am – 12.00pm Place: Karumo Technical Training Institute, Meru County</p> <p>(B) Pre-Tender meeting shall take place at the following date, time and place: <u><i>Shall not take place</i></u></p> <p>Date: Time: Place:</p>
ITT 7.3	The Tenderer will submit any questions in writing, to reach the Procuring Entity not later than <u><i>three (3) days before tender closing date</i></u>
ITT 7.5	The Procuring Entity's website where Minutes of the pre-Tender meeting and the pre-arranged pretender will be published is: <u><i>N/A</i></u>
ITT 9.1	<p>For Clarification of Tender purposes, for obtaining further information and for purchasing tender documents, the Procuring Entity's address is:</p> <p>Name of Procuring Entity: <i>KARUMO TECHNICAL TRAINING INSTITUTE</i></p> <p>(1) Physical address for hand Courier Delivery to an office or Tender Box (City, Street, Building, Floor Number and Room) <u><i>As indicated in the tender advertisement</i></u></p> <p>(2) Postal Address <i>P.O.BOX 276-60602 KIANJAI</i></p> <p>(3) Insert name, telephone number and e-mail address of the officer to be contacted: <u><i>As indicated in the tender advertisement</i></u></p>
C. Preparation of Tenders	
ITT 11.1 (h)	The Tenderer shall submit the following additional documents in its Tender: <i>As listed under Section III-Evaluation and Qualification Criteria under the heading: Preliminary Examination for Determination of Responsiveness</i>
ITT 13.1	Alternative Tenders <i>shall not</i> be considered.
ITT 13.2	Alternative times for completion <i>shall not be</i> permitted.
ITT 13.4	Alternative technical solutions shall be permitted for the following parts of the Works: <i>Not applicable</i>
ITT 14.5	The prices quoted by the Tenderer shall be: <i>Fixed</i>
ITT 15.2 (a)	Foreign currency requirements <i>not allowed</i> .
ITT 18.1	The Tender validity period shall be <u><i>120</i></u> days.

ITT 18.3	<p>(a) The Number of days beyond the expiry of the initial tender validity period will be <u>30</u> days.</p> <p>(b) The Tender price shall be adjusted by the following percentages of the tender price:</p> <p>(i) By <u>(Not applicable) %</u> the local currency portion of the Contract price adjusted to reflect local inflation during the period of extension, and</p> <p>(ii) By <u>(Not applicable) %</u> the foreign currency portion of the Contract price adjusted to reflect the international inflation during the period of extension.</p>
ITT 19.1	Tender shall provide a Tender Security. The type of Tender security shall be <i>Bank guarantee</i> in the amount of Kenya shillings 855,000.00
ITT 20.1	In addition to the original of the Tender, the number of copies is: One (1)
ITT 20.3	The written confirmation of authorization to sign on behalf of the Tenderer shall consist of proof of Power of attorney
D. Submission and Opening of Tenders	
ITT 22.1	<p>(A) For <u>Tender submission purposes</u> only, the Procuring Entity's address is:</p> <p>(1) Name of Procuring Entity: KARUMO TECHNICAL TRAINING INSTITUTE</p> <p>(2) Postal Address: P.O.BOX 276-60602 KIANJAI</p> <p>(3) Physical address for hand Courier Delivery to an office or Tender Box (City, Street, Building, Floor Number and Room) As indicated in tender advertisement</p> <p>(4) Date and time for submission of Tenders: As indicated in tender advertisement</p> <p>(5) Tenders shall shall not submit tenders electronically.</p>
ITT 25.1	<p>The Tender opening shall take place at the time and the address for Opening of Tenders Provided below: As indicated in the tender advertisement</p> <p>(1) Name of Procuring Entity</p> <p>(2) Physical address for the location (City, Street, Building, Floor Number and Room)</p> <p>(3) State date and time of tender opening.</p>
ITT 25.1	If Tenderers are allowed to submit Tenders electronically, they shall follow the electronic tender submission procedures specified below: As indicated in the tender advertisement
E. Evaluation, and Comparison of Tenders	
ITT 30.3	The adjustment shall be based on the average price of the item or component as quoted in other substantially responsive Tenders. If the price of the item or component cannot be derived from the price of other substantially responsive Tenders, the Procuring Entity shall use its best estimate.
ITT 32	<p>The currency that shall be used for Tender evaluation and comparison purposes only to convert at the selling exchange rate all Tender prices expressed in various currencies into a single currency is: Kenya Shillings</p> <p>The source of exchange rate shall be: The Central bank of Kenya (mean rate)</p> <p>The date for the exchange rate shall be: the deadline date for Submission of the Tenders.</p>

ITT 33.2	A margin of preference <i>shall not</i> apply.
ITT 33.4	The invitation to tender is extended to the following group that qualify for Reservations <i>Not applicable</i>
ITT 34.1	At this time, the Procuring Entity <i>does not intend</i> to execute certain specific parts of the Works by subcontractors selected in advance.
ITT 34.2	Contractor's may propose subcontracting: Maximum percentage of subcontracting permitted is: 10 % <i>of the total contract amount</i> . Tenderers planning to subcontract more than 10% of total volume of work shall specify, in the Form of Tender, the activity (ies) or parts of the Works to be subcontracted along with complete details of the subcontractors and their qualification and experience.
ITT 34.3	The parts of the Works for which the Procuring Entity permits Tenderers to propose Specialized Subcontractors are designated as follows: <i>Not Applicable</i> For the above-designated parts of the Works that may require Specialized Subcontractors, the relevant qualifications of the proposed Specialized Subcontractors will be added to the qualifications of the Tenderer for the purpose of evaluation.
ITT 35.2 (e)	Additional requirements apply. These are detailed in the evaluation criteria in Section III, Evaluation and Qualification Criteria
ITT 48.1	Other documents required in addition to the Performance Security are: N/A
ITT 50	<p>The procedures for making a Procurement-related Complaint are detailed in the "Notice of Intention to Award the Contract" herein and are also available from the PPRA Website www.ppra.go.ke or email complaints@ppra.go.ke.</p> <p>If a Tenderer wishes to make a Procurement-related Complaint, the Tenderer should submit its complaint following these procedures, in writing (by the quickest means available, that is either by hand delivery or email to: <u>As indicated in the tender advertisement</u></p> <p>For the attention: <i>[insert full name of person receiving complaints]</i></p> <p>Title/position: <i>[insert title/position]</i></p> <p>Procuring Entity: <i>[insert name of Procuring Entity]</i></p> <p>Email address: <i>[insert email address]</i></p> <p>In summary, a Procurement-related Complaint may challenge any of the following (among others):</p> <ul style="list-style-type: none"> (i) the terms of the Tender Documents; and (ii) the Procuring Entity's decision to award the contract.

SECTION III - EVALUATION AND QUALIFICATION CRITERIA

1.0 GENERAL PROVISIONS

- 10** This section contains the criteria that the Employer shall use to evaluate tender and qualify tenderers. No other factors, methods or criteria shall be used other than specified in this tender document. The Tenderer shall provide all the information requested in the forms included in Section IV, Tendering Forms. The Procuring Entity shall use **the Standard Tender Evaluation Document for Goods and Works** for evaluating Tenders.
- 11** Wherever a Tenderer is required to state a monetary amount, Tenderers should indicate the Kenya Shilling equivalent using the rate of exchange determined as follows:
- For construction turnover or financial data required for each year - Exchange rate prevailing on the last day of the respective calendar year (in which the amounts for that year is to be converted) was originally established.
 - Value of single contract - Exchange rate prevailing on the date of the contract signature.
 - Exchange rates shall be taken from the publicly available source identified in the ITT 14.3. Any error in determining the exchange rates in the Tender may be corrected by the Procuring Entity.

12 EVALUATION AND CONTRACT AWARD CRITERIA

The Procuring Entity shall use the criteria and methodologies listed in this Section to evaluate tenders and arrive at the Lowest Evaluated Tender. The tender that (i) meets the qualification criteria, (ii) has been determined to be substantially responsive to the Tender Documents, and (iii) is determined to have the Lowest Evaluated Tender price shall be selected for award of contract.

2.0 PRELIMINARY EXAMINATION FOR DETERMINATION OF RESPONSIVENESS

Preliminary examination for Determination of Responsiveness

The Procuring Entity will start by examining all tenders to ensure they meet in all respects the eligibility criteria and other mandatory requirements in the ITT, and that the tender is complete in all aspects in meeting the requirements provided for in the preliminary evaluation criteria outlined below. The Standard Tender Evaluation Report Document for Goods and Works for evaluating Tenders provides very clear guide on how to deal with review of these requirements. Tenders that do not pass the Preliminary Examination will be considered non- responsive and will not be considered further.

S/No	PRELIMINARY EVALUATION CRITERIA / MANDATORY REQUIREMENTS
MR1	Dully filled and signed form of tender prepared in accordance with ITT 12
MR2	Dully filled Schedules including priced Bill of Quantities, completed in accordance with ITT 12 and ITT 14;
MR3	Provide proof of registration with the; <ul style="list-style-type: none"> • National Construction Authority (NCA) category 5, 4, or 3 under builders works category • National Construction Authority (NCA) category 6, 5, or 4 under electrical works category • National Construction Authority (NCA) category 7 or 6 under Mechanical works –Plumbing and drainage category with current annual contractors practicing licenses.
MR4	Current class of licence with Energy and Petroleum Regulatory Authority (EPRA Class C1)
MR5	Valid license from Communication Authority of Kenya (CAK)
MR6	Must submit one original copy of the Tender Document and one copy .
MR7	Properly bound, paginated, serialized tender document (each page of the tender submission must have a number and the numbers must be in chronological order). For pagination, Arabic Numerals shall be used, i.e. 1,2,3,4,5,6,7,8,9,10.....n (n being the last numerical page of the tender document)
MR8	Tender Security in accordance with ITT 19.1; from a bank or insurance company approved by Public Procurement Regulatory Authority (PPRA) in the amount of Kenya shillings 855,000.00 . The tender security shall be as per the form included in Section IV, Tender Forms.

MR9	Provide proof of power of attorney (of tender signatory if not director of the company/ partner, signed and stamped by Commissioner of Oaths)
MR10	Valid Copy of Certificate of Incorporation/ Registration. (Certified by a Commissioner of Oaths)
MR11	Valid Current Tax Compliance Certificate, attach TCC checker print out
MR12	Dully filled, signed and stamped Confidential Business Questionnaire
MR13	Valid Copy of Current Single Business permit (for the year 2024)
MR14	Submission of valid CR12 form showing the list of directors /shareholding (issued within the last 6 months) or National Identity Card(s) for Sole Proprietorship/ Partnership
MR15	Letter of authority to seek references from the Tenderer's bankers.
MR16	Must fill and submit the Certificate of Independent Tender Determination in the format provided
MR17	Must fill and submit the Self-declaration form that the person/tenderer is not debarred in the matter of the Public Procurement and Asset Disposal Act 2015 in the format provided - Form SD1.
MR18	Must fill and submit the Self-declaration that the person/tenderer will not engage in any corrupt or fraudulent practice in the format provided - Form SD2
MR19	Must fill and submit Declaration and Commitment to The Code of Ethics in the format provided
MR20	Submit certified copies of audited accounts (Signed by Auditors and Directors) for the last three (3) years (2021,2022 and 2023) (certified by Certified Public Accountants registered with Institute of Certified Public Accountants of Kenya (ICPAK) – Attach valid practicing license)
MR21	Domestic Contractors Agreement – A duly signed and stamped agreement dated within the period of tender for this works between the main contractor and the <ul style="list-style-type: none"> • Electrical installation works subcontractor • Mechanical installation works subcontractor The agreement must be witnessed by advocate (Not necessary if the main contractor is registered for specialist works)
MR22	Provide documentary evidence of being duly registered with the National Hospital Insurance Fund and having a valid NHIF compliance certificate
MR23	Provide documentary evidence of being duly registered with the National Social Security Fund and having a valid NSSF compliance certificate
MR24	Signed Pre-tender site visit certificate

30 TENDER EVALUATION (ITT 35)

Price evaluation: in addition to the criteria listed in ITT 35.2 (a) – (d) the following criteria shall apply:

- (i) Alternative Completion Times, if permitted under ITT 13.2, will be evaluated as follows:
Not Applicable
- (ii) Alternative Technical Solutions for specified parts of the Works, if permitted under ITT 13.4, will be evaluated as follows: *Not Applicable*
- (iii) Other Criteria, if permitted under ITT 35.2(e):
 - a) Technical evaluation as per the Qualification Form
 - b) Financial evaluation as per Section E of the Instruction to Tenderers (ITT).

40 MULTIPLE CONTRACTS – N/A

41 Multiple contracts will be permitted in accordance with ITT 35.4. Tenderers are evaluated on basis of Lots and a lowest evaluated tenderer identified for each Lot. The Procuring Entity will select one Option of the two Options listed below for award of Contracts.

OPTION 1

- (i) If a tenderer wins only one Lot, the tenderer will be awarded a contract for that Lot, provided the tenderer meets the Eligibility and Qualification Criteria for that Lot.
- (ii) If a tenderer wins more than one Lot, the tender will be awarded a contract for all won Lots, provided the tenderer meets the aggregate Eligibility and Qualification Criteria for all the won Lots. The tenderer will be awarded only the combinations for which the tenderer qualifies and the others will be considered for award to second lowest the tenderers.

OPTION 2

The Procuring Entity will consider all possible combinations of won Lots [contract(s)] and determine the combination with the lowest evaluated price. Tenders will then be awarded to the Tenderer or Tenderers in the combination provided the tenderer meets the aggregate Eligibility and Qualification Criteria for all the won Lots.

5.0 ALTERNATIVE TENDERS (ITT 13.1) – N/A

An alternative if permitted under ITT 3.1, will be evaluated as follows:

The Procuring Entity shall consider Tenders offered for alternatives as specified in Part 2 - Works requirements. Only the technical alternatives, if any, of the Tenderer with the Best Evaluated Tender conforming to the basic technical requirements shall be considered by the Procuring Entity.

60 MARGIN OF PREFERENCE – N/A

61 If the TDS so specifies, the Procuring Entity will grant a margin of preference of fifteen percent (15%) to be loaded on evaluated prices of the foreign tenderers, where the percentage of share holding of Kenyan citizens is less than fifty- one percent (51%).

62 Contractors shall be asked to provide, as part of the data for qualification, such information, including details of ownership, as shall be required to determine whether, according to the classification established by the Procuring Entity, a particular contractor or group of contractors qualifies for a margin of preference.

63 After Tenders have been received and reviewed by the Procuring Entity, responsive Tenders shall be assessed to ascertain their percentage of shareholding of Kenyan citizens. Responsive tenders shall be classified into the following groups:

- i) *Group A:* tenders offered by Kenyan Contractors and other Tenderers where Kenyan citizens hold shares of over fifty one percent (51%).
- ii) *Group B:* tenders offered by foreign Contractors and other Tenderers where Kenyan citizens hold shares of less than fifty one percent (51%).

64 All evaluated tenders in each group shall, as a first evaluation step, be compared to determine the lowest tender, and the lowest evaluated tender in each group shall be further compared with each other. If, as a result of this comparison, a tender from Group A is the lowest, it shall be selected for the award of contract. If a tender from Group B is the lowest, an amount equal to the percentage indicated in Item 6.1 of the respective tender price, including unconditional discounts and excluding provisional sums and the cost of day works, if any, shall be added to the evaluated price offered in each tender from Group B. All tenders shall then be compared using new prices with added prices to Group B and the lowest evaluated tender from Group A. If the tender from Group A is still the lowest tender, it shall be selected for award. If not, the lowest evaluated tender from Group B based on the first evaluation price shall be selected.

7. POST QUALIFICATION AND CONTRACT AWARD (ITT 39), MORE SPECIFICALLY,

- a) In case the tender was subject to post-qualification, the contract shall be awarded to the lowest evaluated tenderer, subject to confirmation of pre-qualification data, if so required.
- b) In case the tender was not subject to post-qualification, the tender that has been determined to be the lowest evaluated tenderer shall be considered for contract award, subject to meeting each of the following conditions.
 - i) The Tenderer shall demonstrate that it has access to, or has available, liquid assets, unencumbered real assets, lines of credit, and other financial means (independent of any contractual advance payment) sufficient to meet the construction cash flow of Kenya Shillings **30,000,000.00**.
 - ii) Minimum average annual construction turnover of Kenya Shillings **100,000,000.00**, equivalent calculated as total certified payments received for contracts in progress and/or completed within the last **three (3)** years.
 - iii) At least **Three (3)** of contract(s) of a similar nature executed within Kenya, or the East African Community or a broad, that have been satisfactorily and substantially completed as a prime contractor, or joint venture member or sub-contractor each of minimum value Kenya shillings

30,000,000.00 equivalent.

- iv) Contractor's Representative and Key Personnel, which are specified as *listed in the Qualification Form*.
- v) Contractors key equipment listed on the table "Contractor's Equipment" below and more specifically listed as *listed in the Qualification Form*.
- vi) Other conditions depending on their seriousness.
 - a) **History of non-performing contracts:**
Tenderer and each member of JV in case the Tenderer is a JV, shall demonstrate that Non-performance of a contract did not occur because of the default of the Tenderer, or the member of a JV in the last **three (3) years**. The required information shall be furnished in the appropriate form.
 - b) **Pending Litigation**
Financial position and prospective long-term profit ability of the Single Tenderer, and in the case the Tenderer is a JV, of each member of the JV, shall remain sound according to criteria established with respect to Financial Capability under Paragraph (i) above if all pending litigation will be resolved against the Tenderer. Tenderer shall provide information on pending litigations in the appropriate form.
 - c) **Litigation History**

There shall be no consistent history of court/arbitral award decisions against the Tenderer, in the last **3 years**. All parties to the contract shall furnish the information in the appropriate form about any litigation or arbitration resulting from contracts completed or on going under its execution over the years specified. A consistent history of awards against the Tenderer or any member of a JV may result in rejection of the tender.

QUALIFICATION FORM

Item No.	Qualification Subject	Qualification Requirement	Document To be Completed by Tenderer	For Procuring Entity's Use (Qualification met or Not Met)
1. ELIGIBILITY				
1.1	Nationality	Nationality in accordance with ITT 3.6	Forms ELI - 1.1 and 1.2, with attachments	
1.2	Tax Obligations for Kenyan Tenderers	Has produced a current tax clearance certificate or tax exemption certificate issued by Kenya Revenue Authority in accordance with ITT 3.14.	Attachment	
1.3	Conflict of Interest	No conflicts of interest in accordance with ITT 3.3	Form of Tender	
1.4	PPRA Eligibility	Not having been declared ineligible by the PPRA as described in ITT 3.7	Form of Tender	
1.5	State- owned Enterprise	Meets conditions of ITT 3.8	Forms ELI - 1.1 and 1.2, with attachments	
1.6	Goods, equipment and services to be supplied under the contract	To have their origin in any country that is not determined ineligible under ITT 4.1	Forms ELI - 1.1 and 1.2, with attachments	
2. HISTORICAL CONTRACT NON-PERFORMANCE				
2.1	History of Non- Performing Contracts	Non-performance of a contract did not occur as a result of contractor default since 1 st January 2019.	Form CON-2	
2.2	Suspension Based on Execution of Tender/Proposal Securing Declaration by the Procuring Entity	Not under suspension based on-execution of a Tender/Proposal Securing Declaration pursuant to ITT 19.9	Form of Tender	
2.3	Pending Litigation	Tender's financial position and prospective long-term profitability still sound according to criteria established in 3.1 and assuming that all pending litigation will NOT be resolved against the Tenderer.	Form CON - 2	
2.4	Litigation History	No consistent history of court/arbitral award decisions against the tenderer since 1 st January 2019	Form CON - 2	

1. Non performance, as decided by the Employer, shall include all contracts where (a) nonperformance was not challenged by the contractor, including through referral to the dispute resolution mechanism under the respective contract, and (b) contracts that were so challenged but fully settled against the contractor. Non performance shall not include contracts where Employers decision was overruled by the dispute resolution mechanism. Non performance must be based on all information on fully settled disputes or litigation, i.e. dispute or litigation that has been resolved in accordance with the dispute resolution mechanism under the respective contract and where all appeal instances available to the Bidder have been exhausted.
2. This requirement also applies to contracts executed by the Bidder as JV member.

Qualification form cont'd

Item No.	Qualification Subject	Qualification Requirement	Document To be Completed by Tenderer	For Procuring Entity's Use (Qualification met or Not Met)
3. FINANCIAL SITUATION AND PERFORMANCE				
3.1	Financial Capabilities	The Tenderer shall submit the audited balance sheets or, if not required by the laws of the Tenderer's country, other financial statements acceptable to the Procuring Entity, for the last three (3) years shall be submitted and must demonstrate the current soundness of the Tenderer's financial position and indicate its prospective long-term profitability.	Form FIN - 3.1, with attachments	
3.2	Average Annual Construction Turnover	The Tenderer shall demonstrate that it has a minimum average annual construction turnover of Kenya Shillings 100,000,000.00, equivalent calculated as total certified payments received for contracts in progress and/or completed within the last 3 years	Form FIN - 3.2 with attachments	
3.3	Financial Resources	The Tenderers shall demonstrate, to the satisfaction of the Procuring Entity, that it has adequate sources of finance, or has available, liquid assets, unencumbered real assets, lines of credit, and other financial means (independent of any contractual advance payment) to meet the cash flow requirements estimated as Kenya Shillings 30,000,000.00 for works the subject contract(s) net of the Tenderer's other commitments.	Form FIN - 3.3 with attachments	
3.4	Current Contract Commitments / Works in Progress	Tenderers and each member to a JV should provide information on their current commitments on all contracts that have been awarded, or for which a letter of intent or acceptance has been received, or for contracts approaching completion, but for which an unqualified, full completion certificate has yet to be issued. <i>(Tenderer to attach evidence such as copies of letter of award, Signed contract and copies of interim payment certificates)</i>	Form FIN - 3.4 with attachments	

Qualification form Cont'd

Item No.	Qualification Subject	Qualification Requirement	Document To be Completed by Tenderer	For Procuring Entity's Use (Qualification met or Not Met)
	4. EXPERIENCE			
4.1	General Construction Experience	Experience under construction contracts in the role of prime contractor, JV member, sub-contractor, or management contractor for at least the last 3 years, starting 1 st January 2019	4. Form EXP - 4.1 Experience	
4.2 (a)	Specific Construction & Contract Management Experience	A minimum number of 3 similar contracts specified below that have been satisfactorily and substantially completed as a prime contractor, joint venture member, management contractor or sub-contractor between 1st January 2019 and tender submission deadline i.e. ... (number) contracts, each of minimum value Kenya shillings 30,000,000.00 equivalent. Bidders shall attach copies of the following: a) Letters of Award or, b) Signed Contract and Completion Certificate for the respective projects. or c) If project is ongoing it must be at least 80% complete. Bidder to attach copies of interim payment certificates	Form EXP 4.2(a)	
4.2 (b)	Construction Experience in Key Activities	<i>-Not applicable</i>	<i>-Not Applicable</i>	<i>-Not applicable</i>

1. The similarity shall be based on the physical size, complexity, methods/technology and/or other characteristics described in the Bills of Quantities and Drawings. Summation of number of small value contracts (less than the value specified under requirement) to meet the overall requirement will not be accepted.
2. Substantial completion shall be based on 80% or more works completed under the contract.
3. For contracts under which the Bidder participated as a joint venture member or sub-contractor, only the Bidder's share, by value, shall be considered to meet this requirement.
4. In the case of JV, the value of contracts completed by its members shall not be aggregated to determine whether the requirement of the minimum value of a single contract has been met. Instead, each contract performed by each member shall satisfy the minimum value of a single contract as required for single entity. In determining whether the JV meets the requirement of total number of contracts, only the number of contracts completed by all members each of value equal or more than the minimum value required shall be aggregated.

Qualification form Cont'd

Item No.	Qualification Subject	Qualification Requirement	Document To be Completed by Tenderer	For Procuring Entity's Use (Qualification met or Not Met)
5. Equipment				
5.1	Contractors key equipment/tools	<ol style="list-style-type: none"> 1. Lorry- One (3) 2. Tippers- One (2) 3. Pick-ups- One(2) 4. 2 No. Water Bowser - ($\geq 7,000$ Lts) 5. Digital Earth Resistance tester 6. Motor and phase rotation indicator 7. Digital Earth loop tester 8. Insulation Continuity tester 9. Multimeter and clamp meter <p>Notes</p> <ul style="list-style-type: none"> • If the equipment is owned, must provide CLEAR copies of logbook or proof of ownership. • If equipment is hired or leased Provide a commitment letter from the lessor of the equipment addressed to the REGIONAL WORKS OFFICER – EASTERN REGION indicating that the lessor shall avail the equipment upon award of the tender and submit a copy of a written agreement to lease between lessee and lessor indicating list of equipment and their corresponding copies of log books or proof of ownership by lessor; • The equipment listed shall be available on site when required 	Form EQU: Equipment	

Item No.	Qualification Subject	Qualification Requirement	Document To be Completed by Tenderer	For Procuring Entity's Use (Qualification met or Not Met)
6. Key Personnel				
6.1	Contractor's Representative and Key Personnel	<p>a) Project Manager <u>Minimum qualifications and technical experience</u></p> <ol style="list-style-type: none"> 1. Bachelor's degree in Architecture, Quantity Surveying, or Civil / Structural Engineering. 2. Registered Professional with the respective registration bodies Engineers Board of Kenya (EBK) or Board of Registration of Architects and Quantity Surveyors (BORAQS) 3. Specific experience on Construction of building works – 7 years. <p>b) Site Agent <u>Minimum qualifications and technical experience</u></p> <ol style="list-style-type: none"> 1. Diploma in Building Construction or equivalent. 2. Experience on Construction of building works – 6 years. <p>c) Foreman <u>Minimum qualifications and technical experience</u></p> <ol style="list-style-type: none"> 1. Diploma- Building Construction, Electrical, Mechanical 2. Experience – 5 years <p>d) Electrician <u>Minimum qualifications and technical experience</u></p> <ol style="list-style-type: none"> 1. Diploma in Electrical Engineering or its equivalent 2. Experience – 5 years <p>e) Plumber <u>Minimum qualifications and technical experience</u></p> <ol style="list-style-type: none"> 1. Diploma in mechanical engineering or its equivalent 2. Experience – 5 years 	Form PER -1 & Form PER -2	

SECTION IV - TENDERING FORMS

QUALIFICATION FORMS

1. FOREIGN TENDERERS 40% RULE

Pursuant to ITT 3.9, a foreign tenderer must complete this form to demonstrate that the tender fulfils this condition.

ITEM	Description of work item	Description of location of source	COST IN K.Shillings	Comments, If any
A	LOCAL LABOR			
1				
2				
3				
4				
5				
B	SUB CONTRACTS FROM LOCAL SOURCES			
1				
2				
3				
4				
5				
C	LOCAL MATERIALS			
1				
2				
3				
4				
5				
D	USE OF LOCAL PLANT AND EQUIPMENT			
1				
2				
3				
4				
5				
E	ADD ANY OTHER ITEM			
1				
2				
3				
4				
5				
6				
	TOTAL COST OF LOCAL CONTENT			
	PERCENTAGE OF CONTRACT PRICE			

2. FORM EQU: EQUIPMENT

The Tenderer shall provide adequate information to demonstrate clearly that it has the capability to meet the requirements for the key equipment listed in Section III, Evaluation and Qualification Criteria. A separate Form shall be prepared for each item of equipment listed, or for alternative equipment proposed by the Tenderer.

Item of equipment		
Equipment information	Name of manufacturer	Model and power rating
	Capacity	Year of manufacture
Current	Current location	
	Indicate source of the equipment <input type="checkbox"/> Owned <input type="checkbox"/> Rented <input type="checkbox"/> Leased <input type="checkbox"/> Specially manufactured	
	Omit the following information for equipment owned by the Tenderer.	
Owner	Name of owner	
	Address of owner	
	Telephone	Contact name and title
	Fax	Telex
Agreements	Details of rental / lease / manufacture agreements specific to the project	

3. FORM PER -1

Contractor's Representative and Key Personnel Schedule

Tenderers should provide the names and details of the suitably qualified Contractor's Representative and Key Personnel to perform the Contract. The data on their experience should be supplied using the Form PER-2 below for each candidate.

Contractor' Representative and Key Personnel

1.	Title of position: Contractor's Representative	
	Name of candidate:	
	Duration of appointment:	<i>[insert the whole period (start and end dates) for which this position will be engaged]</i>
	Time commitment: for this position:	<i>[insert the number of days/week/months/ that has been scheduled for this position]</i>
	Expected time schedule for this position:	<i>[insert the expected time schedule for this position (e.g. attach high level Gantt chart)]</i>
2.	Title of position: [_____]	
	Name of candidate :	
	Duration of appointment:	<i>[insert the whole period (start and end dates) for which this position will be engaged]</i>
	Time commitment: for this position:	<i>[insert the number of days/week/months/ that has been scheduled for this position]</i>
	Expected time schedule for this position:	<i>[insert the expected time schedule for this position (e.g. attach high level Gantt chart)]</i>
3.	Title of position: [_____]	
	Name of candidate :	
	Duration of appointment:	<i>[insert the whole period (start and end dates) for which this position will be engaged]</i>
	Time commitment: for this position:	<i>[insert the number of days/week/months/ that has been scheduled for this position]</i>
	Expected time schedule for this position:	<i>[insert the expected time schedule for this position (e.g. attach high level Gantt chart)]</i>
4.	Title of position: [_____]	
	Name of candidate :	
	Duration of appointment:	<i>[insert the whole period (start and end dates) for which this position will be engaged]</i>
	Time commitment: for this position:	<i>[insert the number of days/week/months/ that has been scheduled for this position]</i>
	Expected time schedule for this position:	<i>[insert the expected time schedule for this position (e.g. attach high level Gantt chart)]</i>
5.	Title of position: <i>[insert title]</i>	
	Name of candidate	
	Duration of appointment:	<i>[insert the whole period (start and end dates) for which this position will be engaged]</i>
	Time commitment: for this position:	<i>[insert the number of days/week/months/ that has been scheduled for this position]</i>
	Expected time schedule for this position:	<i>[insert the expected time schedule for this position (e.g. attach high level Gantt chart)]</i>

4. **FORM PER - 2:**

Resume and Declaration - Contractor's Representative and Key Personnel.

Name of Tenderer		
Position[#I][title of position from Form PER-1]		
Personnel information	Name:	Date of birth:
	Address:	E-mail:
	Professional qualifications:	
	Academic qualifications:	
	Language proficiency: [language and levels of speaking, reading and writing skills]	
Details	Address of Procuring Entity:	
	Telephone:	Contact (manager / personnel officer):
	Fax:	
	Jobtitle:	Years with present Procuring Entity:

Summarize professional experience in reverse chronological order. Indicate particular technical and managerial experience relevant to the project.

Project	Role	Duration of involvement	Relevant experience
[main project details]	[role and responsibilities on the project]	[time in role]	[describe the experience relevant to this position]

Declaration

I, the undersigned [insert either "Contractor's Representative" or "Key Personnel" as applicable], certify that to the best of my knowledge and belief, the information contained in this Form PER-2 correctly describes myself, my qualifications and my experience.

I confirm that I am available as certified in the following table and throughout the expected time schedule for this position as provided in the Tender:

Commitment	Details
Commitment to duration of contract:	<i>[insert period (start and end dates) for which this Contractor's Representative or Key Personnel is available to work on this contract]</i>
Time commitment:	<i>[insert period (start and end dates) for which this Contractor's Representative or Key Personnel is available to work on this contract]</i>

I understand that any misrepresentation or omission in this Form may:

- a) be taken into consideration during Tender evaluation;
- b) result in my disqualification from participating in the Tender;
- c) result in my dismissal from the contract.

Name of Contractor's Representative or Key Personnel: *[insert name]*

Signature: _____

Date: (day month year): _____

Counter signature of authorized representative of the Tenderer:

Signature: _____

Date: (day month year): _____

5. TENDERERS QUALIFICATION WITHOUT PREQUALIFICATION

To establish its qualifications to perform the contract in accordance with Section III, Evaluation and Qualification Criteria the Tenderer shall provide the information requested in the corresponding Information Sheets included hereunder.

51 FORM ELI -1.1

Tenderer Information Form

Date: _____

ITT No. and title: _____

Tenderer's name
In case of Joint Venture (JV), name of each member:
Tenderer's actual or intended country of registration: <i>[indicate country of Constitution]</i>
Tenderer's actual or intended year of incorporation:
Tenderer's legal address [in country of registration]:
Tenderer's authorized representative information Name: _____ Address: _____ Telephone/Fax numbers: _____ E-mail address: _____
1. Attached are copies of original documents of <input type="checkbox"/> Articles of Incorporation (or equivalent documents of constitution or association), and/or documents of registration of the legal entity named above, in accordance with ITT 3.6 <input type="checkbox"/> In case of JV, letter of intent to form JV or JV agreement, in accordance with ITT 3.5 <input type="checkbox"/> In case of state-owned enterprise or institution, in accordance with ITT 3.8, documents establishing: <ul style="list-style-type: none">• Legal and financial autonomy• Operation under commercial law• Establishing that the Tenderer is not under the supervision of the Procuring Entity
2. Included are the organizational chart, a list of Board of Directors, and the beneficial ownership.

52 FORM ELI -1.2

**Tenderer's JV Information Form
(to be completed for each member of Tenderer's JV)**

Date: _____

ITT No. and title: _____

Tenderer's JV name:
JV member's name:
JV member's country of registration:
JV member's year of constitution:
JV member's legal address in country of constitution:
JV member's authorized representative information Name: _____ Address: _____ Telephone/Fax numbers: _____ E-mail address: _____
1. Attached are copies of original documents of <input type="checkbox"/> Articles of Incorporation (or equivalent documents of constitution or association), and/or registration documents of the legal entity named above, in accordance with ITT 3.6. <input type="checkbox"/> In case of a state-owned enterprise or institution, documents establishing legal and financial autonomy, operation in accordance with commercial law, and that they are not under the supervision of the Procuring Entity, in accordance with ITT 3.5. 2. Included are the organizational chart, a list of Board of Directors, and the beneficial ownership.

53 FORM CON –2

Historical Contract Non-Performance, Pending Litigation and Litigation History

Tenderer's Name: _____ Date: _____

JV Member's Name _____ ITT No. and title: _____

Non-Performed Contracts in accordance with Section III, Evaluation and Qualification Criteria			
<input type="checkbox"/> Contract non-performance did not occur since 1 st January <i>[insert year]</i> specified in Section III, Evaluation and Qualification Criteria, Sub-Factor 2.1.			
<input type="checkbox"/> Contract(s) not performed since 1 st January <i>[insert year]</i> specified in Section III, Evaluation and Qualification Criteria, requirement 2.1			
<input type="checkbox"/> Contract(s) withdrawn since 1 st January <i>[insert year]</i> specified in Section III, Evaluation and Qualification Criteria, requirement 2.1			
Year	Non- performed portion of contract	Contract Identification	Total Contract Amount (current value, currency, exchange rate and Kenya Shilling equivalent)
<i>[insert year]</i>	<i>[insert amount and percentage]</i>	Contract Identification: <i>[indicate complete contract name/ number, and any other identification]</i> Name of Procuring Entity: <i>[insert full name]</i> Address of Procuring Entity: <i>[insert street/city/country]</i> Reason(s) for nonperformance: <i>[indicate main reason(s)]</i>	<i>[insert amount]</i>
Pending Litigation, in accordance with Section III, Evaluation and Qualification Criteria			
<input type="checkbox"/> No pending litigation in accordance with Section III, Evaluation and Qualification Criteria, Sub-Factor 2.3.			
<input type="checkbox"/> Pending litigation in accordance with Section III, Evaluation and Qualification Criteria, Sub-Factor 2.3 as indicated below.			

Year of dispute	Amount in dispute (currency)	Contract Identification	Total Contract Amount (currency), Kenya Shilling Equivalent (exchange rate)
		Contract Identification: _____ Name of Procuring Entity: _____ Address of Procuring Entity: _____ Matter in dispute: _____ Party who initiated the dispute: _____ Status of dispute: _____	
		Contract Identification: Name of Procuring Entity: Address of Procuring Entity: Matter in dispute: Party who initiated the dispute: Status of dispute:	
Litigation History in accordance with Section III, Evaluation and Qualification Criteria			
<input type="checkbox"/> No Litigation History in accordance with Section III, Evaluation and Qualification Criteria, Sub-Factor 2.4. <input type="checkbox"/> Litigation History in accordance with Section III, Evaluation and Qualification Criteria, Sub-Factor 2.4 as indicated below.			
Year of award	Outcome as percentage of Net Worth	Contract Identification	Total Contract Amount (currency), Kenya Shilling Equivalent (exchange rate)
<i>[insert year]</i>	<i>[insert percentage]</i>	Contract Identification: [indicate complete contract name, number, and any other identification] Name of Procuring Entity: <i>[insert full name]</i> Address of Procuring Entity: <i>[insert street/city/country]</i> Matter in dispute: <i>[indicate main issues in dispute]</i> Party who initiated the dispute: <i>[indicate "Procuring Entity" or "Contractor"]</i> Reason(s) for Litigation and award decision <i>[indicate main reason(s)]</i>	<i>[insert amount]</i>

Include details relating to potential bid-rigging practices such as previous occasions where tenders were withdrawn, joint bids with competitors, subcontracting work to unsuccessful tenderers, etc.

5.4 FORM FIN – 3.1:

Financial Situation and Performance

Tenderer's Name: _____

Date: _____

JV Member's Name _____

ITT No. and title: _____

5.4.1. Financial Data

Type of Financial information in _____ (currency)	Historic information for previous _____ years, _____ (amount in currency, currency, exchange rate*, USD equivalent)				
	Year1	Year2	Year 3	Year4	Year 5
Statement of Financial Position (Information from Balance Sheet)					
Total Assets (TA)					
Total Liabilities (TL)					
Total Equity/Net Worth (NW)					
Current Assets (CA)					
Current Liabilities (CL)					
Working Capital (WC)					
Information from Income Statement					
Total Revenue (TR)					
Profits Before Taxes (PBT)					
Cash Flow Information					
Cash Flow from Operating Activities					

*Refer to ITT 15 for the exchange rate

542 Sources of Finance

Specify sources of finance to meet the cash flow requirements on works currently in progress and for future contract commitments.

No.	Source of finance	Amount (Kenya Shilling equivalent)
1		
2		
3		

543 Financial documents

The Tenderer and its parties shall provide copies of financial statements for _____ years pursuant Section III, Evaluation and Qualifications Criteria, Sub-factor 3.1. The financial statements shall:

- a) reflect the financial situation of the Tenderer or incase of JV member, and not an affiliated entity (such as parent company or group member).
 - b) Be independently audited or certified in accordance with local legislation.
 - c) Be complete, including all notes to the financial statements.
 - d) Correspond to accounting periods already completed and audited.
- Attached are copies of financial statements¹ for the _____ years required above; and complying with the requirements.

¹If the most recent set of financial statements is for a period earlier than 12 months from the date of Tender, the reason for this should be justified.

5.5 FORM FIN – 3.2:

Average Annual Construction Turnover

Tenderer's Name: _____

Date: _____

JV Member's Name _____

ITT No. and title: _____

Annual turnover data (construction only)			
Year	Amount Currency	Exchange rate	Kenya Shilling equivalent
<i>[indicate year]</i>	<i>[insert amount and indicate currency]</i>		
Average Annual Construction Turnover *			

* See Section III, Evaluation and Qualification Criteria, Sub-Factor 3.2.

5.6 FORMFIN–3.3:

Financial Resources

Specify proposed sources of financing, such as liquid assets, unencumbered real assets, lines of credit, and other financial means, net of current commitments, available to meet the total construction cash flow demands of the subject contractor contracts as specified in Section III, Evaluation and Qualification Criteria.

Financial Resources		
No.	Source of financing	Amount (Kenya Shilling equivalent)
1		
2		
3		
4		

57 FORMFIN-3.4:

Current Contract Commitments / Works in Progress

Tenderers and each member to a JV should provide information on their current commitments on all contracts that have been awarded, or for which a letter of intent or acceptance has been received, or for contracts approaching completion, but for which an unqualified, full completion certificate has yet to be issued.

Current Contract Commitments					
No.	Name of Contract	Procuring Entity's Contact Address, Tel,	Value of Outstanding Work [Current Kenya Shilling /month Equivalent]	Estimated Completion Date	Average Monthly Invoicing Over Last Six Months [Kenya Shilling /month]
1					
2					
3					
4					
5					

58 FORM EXP -4.1

General Construction Experience

Tenderer's Name: _____ Date: _____

JV Member's Name _____ ITT No. and title: _____

Page _____ of _____ pages

Starting Year	Ending Year	Contract Identification	Role of Tenderer
		Contract name: _____ Brief Description of the Works performed by the Tenderer: _____ Amount of contract: _____ Name of Procuring Entity: _____ Address: _____	
		Contract name: _____ Brief Description of the Works performed by the Tenderer: _____ Amount of contract: _____ Name of Procuring Entity: _____ Address: _____	
		Contract name: _____ Brief Description of the Works performed by the Tenderer: _____ Amount of contract: _____ Name of Procuring Entity: _____ Address: _____	

59 FORM EXP - 4.2(a)

Specific Construction and Contract Management Experience

Tenderer's Name: _____

Date: _____

JV Member's Name _____

ITT No. and title: _____

Similar Contract No.	Information			
Contract Identification				
Award date				
Completion date				
Role in Contract	Prime Contractor <input type="checkbox"/>	Member in JV <input type="checkbox"/>	Management Contractor <input type="checkbox"/>	Sub-contractor <input type="checkbox"/>
Total Contract Amount	Kenya Shilling			
If member in a JV or sub-contractor, specify participation in total Contract amount				
Procuring Entity's Name:				
Address: Telephone/fax number E-mail:				
Description of the similarity in accordance with Sub-Factor 4.2(a) of Section III:				
1 Amount				
2 Physical size of required works items				
3 Complexity				
4 Methods/Technology				
5 Construction rate for key activities				
6 Other Characteristics				

5.10 FORM EXP - 4.2 (b)

Construction Experience in Key Activities

Tenderer's Name: _____

Date: _____

Tenderer's JV Member Name: _____

Sub-contractor's Name² (as per ITT 34): _____

ITT No. and title: _____

All Sub-contractors for key activities must complete the information in this form as per ITT 34 and Section III, Evaluation and Qualification Criteria, Sub-Factor 4.2.

1. Key Activity No One:

Information				
Contract Identification				
Award date				
Completion date				
Role in Contract	Prime Contractor <input type="checkbox"/>	Member in JV <input type="checkbox"/>	Management Contractor <input type="checkbox"/>	Sub-contractor <input type="checkbox"/>
Total Contract Amount			Kenya Shilling	
Quantity (Volume, number or rate of production, as applicable) performed under the contract per year or part of the year	Total quantity in the contract (i)	Percentage participation (ii)	Actual Quantity Performed (i) x (ii)	
Year 1				
Year 2				
Year 3				
Year 4				
Procuring Entity's Name:				
Address: Telephone/fax number E-mail:				
Description of the key activities in accordance with Sub-Factor 4.2(b) of Section III:				

²If applicable

OTHER FORMS

6. FORM OF TENDER

(Amended and issued pursuant to PPRA CIRCULAR No. 02/2022)

INSTRUCTIONS TO TENDERERS

- i) *All italicized text is to help the Tenderer in preparing this form.*
- ii) *The Tenderer must prepare this Form of Tender on stationery with its letterhead clearly showing the Tenderer's complete name and business address. Tenderers are reminded that this is a mandatory requirement.*
- iii) *Tenderer must complete and sign CERTIFICATE OF INDEPENDENT TENDER DETERMINATION and the SELF DECLARATION FORMS OF THE TENDERER as listed under (xxii) below.*

Date of this Tender submission:.....[insert date (as day, month and year) of Tender submission] **Tender**

Name **and** **Identification:**.....[insert **identification]** **Alternative**

No.:.....[insert identification No if this is a Tender for an alternative]

To: [Insert complete name of Procuring Entity]

Date of this Tender submission: [insert date (as day, month and year) of Tender submission] **Request for Tender No.:** [insert identification] **Name and description of Tender** [Insert as per ITT) **Alternative No.:** [insert identification No if this is a Tender for an alternative]

To: [insert complete name of Procuring Entity]

Dear Sirs,

1. In accordance with the Conditions of Contract, Specifications, Drawings and Bills of Quantities for the execution of the above named Works, we, the undersigned offer to construct and complete the Works and remedy any defects therein for the sum¹ of Kenya Shillings [Amount in figures] _____ Kenya Shillings [amount in words] _____

The above amount includes foreign currency² amount (s) of [state figure or a percentage and currency] [figures] _____ [words] _____

- 2. We undertake, if our tender is accepted, to commence the Works as soon as is reasonably possible after the receipt of the Architect notice to commence, and to complete the whole of the Works comprised in the Contract within the time stated in the Special Conditions of Contract.
- 3. We agree to adhere by this tender until _____ [Insert date], and it shall remain binding upon us and may be accepted at any time before that date.
- 4. We understand that you are not bound to accept the lowest or any tender you may receive.
- 5. We, the under signed, further declare that:
 - i) No reservations: We have examined and have no reservations to the tender document, including Addenda issued in accordance with ITT 28;
 - ii) Eligibility: We meet the eligibility requirements and have no conflict of interest in accordance with ITT 3 and 4;

¹ This sum should be carried forward from the Summary of the Bills of Quantities.
² The percentage quoted above should not include provisional sums, and not more than two foreign currencies are allowed.

- iii) **Tender - Securing Declaration:** We have not been suspended nor declared ineligible by the Procuring Entity based on execution of a Tender-Securing or Proposal-Securing Declaration in the Procuring Entity's Country in accordance with ITT 19.8;
- iv) **Conformity:** We offer to execute in conformity with the tendering documents and in accordance with the implementation and completion specified in the construction schedule, the following Works: *[insert a brief description of the Works];*
- v) **Tender Price:** The total price of our Tender, excluding any discounts offered in item 1 above is: *[Insert one of the options below as appropriate]*
- vi) **Option 1,** in case of one lot: Total priceis: *[insert the total price of the Tender in words and figures, indicating the various amounts and the respective currencies];* or
Option2, in case of multiple lots:
- (a) **Total price of each lot** *[insert the total price of each lot in words and figures, indicating the various amounts and the respective currencies];* and
- (b) **Total price of all lots** (sum of all lots) *[insert the total price of all lots in words and figures, indicating the various amounts and the respective currencies];*
- vii) **Discounts:** The discounts offered and the methodology for their application are:
- viii) The discounts offered are: *[Specify in detail each discount offered.]*
- ix) The exact method of calculations to determine the net price after application of discounts is shown below: *[Specify in detail the method that shall be used to apply the discounts];*
- x) **Tender Validity Period:** Our Tender shall be valid for the period specified in TDS 18.1 (as amended, if applicable) from the date fixed for the Tender submission deadline specified in TDS 22.1 (as amended, if applicable), and it shall remain binding upon us and may be accepted at any time before the expiration of that period;
- xi) **Performance Security:** If our Tender is accepted, we commit to obtain a Performance Security in accordance with the Tendering document;
- xii) **One Tender Per Tender:** We are not submitting any other Tender(s) as an individual Tender, and we are not participating in any other Tender(s) as a Joint Venture member or as a sub-contractor, and meet the requirements of ITT 3.4, other than alternative Tenders submitted in accordance with ITT 13.3;
- xiii) **Suspension and Debarment:** We, along with any of our subcontractors, suppliers, Engineer, manufacturers, or service providers for any part of the contract, are not subject to, and not controlled by any entity or individual that is subject to, a temporary suspension or a debarment imposed by the Public Procurement Regulatory Authority or any other entity of the Government of Kenya, or any international organization.
- xiv) **State-owned enterprise or institution:** *[select the appropriate option and delete the other] [We are not a state-owned enterprise or institution]/[We are a state-owned enterprise or institution but meet the requirements of ITT3.8];*
- xv) **Commissions, gratuities, fees:** We have paid, or will pay the following commissions, gratuities, or fees with respect to the tender process or execution of the Contract: *[insert complete name of each Recipient, its full address, the reason for which each commission or gratuity was paid and the amount and currency of each such commission or gratuity].*

Name of Recipient	Address	Reason	Amount

(If none has been paid or is to be paid, indicate "none.")

- xvi) **Binding Contract:** We understand that this Tender, together with your written acceptance there of included in your Letter of Acceptance, shall constitute a binding contract between us, until a formal contract is prepared and executed;
- xvii) **Not Bound to Accept:** We understand that you are not bound to accept the lowest evaluated cost Tender, the Most Advantageous Tender or any other Tender that you may receive;
- xviii) **Fraud and Corruption:** We here by certify that we have taken steps to ensure that no person acting for us or on our behalf engages in any type of Fraud and Corruption; and
- xix) **Collusive practices:** We hereby certify and confirm that the tender is genuine, non-collusive and made with the intention of accepting the contract if awarded. To this effect we have signed the “Certificate of Independent Tender Determination” attached below.
- xx) We undertake to adhere by the Code of Ethics for Persons Participating in Public Procurement and Asset Disposal, copy available from _____ (*specify website*) during the procurement process and the execution of any resulting contract.
- xxi) **Beneficial Ownership Information:** We commit to provide to the procuring entity the Beneficial Ownership Information in conformity with the Beneficial Ownership Disclosure Form upon receipt of notification of intention to enter into a contract in the event we are the successful tenderer in this subject procurement proceeding.
- xxii) We, the Tenderer, have duly completed, signed and stamped the following Forms as part of our Tender:
 - a) Tenderer's Eligibility; Confidential Business Questionnaire - to establish we are not in any conflict of interest.
 - (b) Certificate of Independent Tender Determination - to declare that we completed the tender without colluding with other tenderers.
 - (a) Self-Declaration of the Tenderer - to declare that we will, if awarded a contract, not engage in any form of fraud and corruption.
 - (d) Declaration and commitment to the Code of Ethics for Persons Participating in Public Procurement and Asset Disposal.

Further, we confirm that we have read and understood the full content and scope of fraud and corruption as informed in “**Appendix 1 - Fraud and Corruption**” attached to the Form of Tender.

Name of the Tenderer: **[insert complete name of person signing the Tender]*

Name of the person duly authorized to sign the Tender on behalf of the Tenderer: ***[insert complete name of person duly authorized to sign the Tender]*

Title of the person signing the Tender: *[insert complete title of the person signing the Tender]*

Signature of the person named above: *[insert signature of person whose name and capacity are shown above]*

Date signed *[insert date of signing]* day of *[insert month]*, *[insert year]*

Dated signed _____ day of _____.

Notes

- * In the case of the Tender submitted by joint venture specify the name of the Joint Venture as Tenderer.*
- **Person signing the Tender shall have the power of attorney given by the Tenderer to be attached with the Tender.*

(a) **TENDERER'S ELIGIBILITY-CONFIDENTIAL BUSINESS QUESTIONNAIRE**

Instruction to Tenderer

Tender is instructed to complete the particulars required in this Form, *one form for each entity if Tender is a JV*. Tenderer is further reminded that it is an offence to give false information on this Form.

(a) Tenderer's details

	ITEM	DESCRIPTION
1	Name of the Procuring Entity	
2	Reference Number of the Tender	
3	Date and Time of Tender Opening	
4	Name of the Tenderer	
5	Full Address and Contact Details of the Tenderer.	1. Country 2. City 3. Location 4. Building 5. Floor 6. Postal Address 7. Name and email of contact person.
6	Current Trade License Registration Number and Expiring date	
7	Name, country and full address (<i>postal and physical addresses, email, and telephone number</i>) of Registering Body/Agency	
8	Description of Nature of Business	
9	Maximum value of business which the Tenderer handles.	
10	State if Tenders Company is listed in stock exchange, give name and full address (<i>postal and physical addresses, email, and telephone number</i>) of state which stock exchange	

General and Specific Details

(b) Sole Proprietor, provide the following details.

Name in full _____ Age _____
 Nationality _____ Country of Origin _____
 Citizenship _____

(c) Partnership, provide the following details.

	Names of Partners	Nationality	Citizenship	% Shares owned
1				
2				
3				

(d) Registered Company, provide the following details.

- I) Private or public Company _____
- ii) State the nominal and issued capital of the Company _____

Nominal Kenya Shillings (Equivalent).....

Issued Kenya Shillings (Equivalent).....

iii) Give details of Directors as follows.

	Names of Director	Nationality	Citizenship	% Shares owned
1				
2				
3				

(e) DISCLOSURE OF INTEREST - Interest of the Firm in the Procuring Entity.

- i) Are there any person/persons in..... (*Name of Procuring Entity*) who has/have an interest or relationship in this firm? Yes/No.....

If yes, provide details as follows.

	Names of Person	Designation in the Procuring Entity	Interest or Relationship with Tenderer
1			
2			
3			

(ii) **Conflict of interest disclosure**

	Type of Conflict	Disclosure YES ORNO	If YES provide details of the relationship with Tenderer
1	Tenderer is directly or indirectly controls, is controlled by or is under common control with another tenderer.		
2	Tenderer receives or has received any direct or indirect subsidy from another tenderer.		
3	Tenderer has the same legal representative as another tenderer		
4	Tender has a relationship with another tenderer, directly or through common third parties, that puts it in a position to influence the tender of another tenderer, or influence the decisions of the Procuring Entity regarding this tendering process.		
5	Any of the Tenderer's affiliates participated as a consultant in the preparation of the design or technical specifications of the works that are the subject of the tender.		
6	Tenderer would be providing goods, works, non-consulting services or consulting services during implementation of the contract Specified in this Tender Document.		
7	Tenderer has a close business or family relationship with a professional staff of the Procuring Entity who are directly or indirectly involved in the preparation of the Tender document or specifications of the Contract, and/or the Tender evaluation process of such contract.		
8	Tenderer has a close business or family relationship with a professional staff of the Procuring Entity who would be involved in the implementation or supervision of the such Contract.		
9	Has the conflict stemming from such relationship stated in item 7 and 8 above been resolved in a manner acceptable to the Procuring Entity throughout the tendering process and execution of the Contract.		

Certification

On behalf of the Tenderer, I certify that the information given above is complete, current and accurate as at the date of submission.

Full Name _____

Title or Designation _____

(Signature)

(Date)

b) CERTIFICATE OF INDEPENDENT TENDER DETERMINATION

I, the undersigned, in submitting the accompanying Letter of Tender to the _____
_____ [Name of Procuring Entity] for:
_____ [Name and number of tender] in
response to the request for tenders made by: _____ [Name of Tenderer] do hereby
make the following statements that I certify to be true and complete in every respect:

I certify, on behalf of _____ [Name of Tenderer] that:

1. I have read and I understand the contents of this Certificate;
2. I understand that the Tender will be disqualified if this Certificate is found not to be true and complete in every respect;
3. I am the authorized representative of the Tenderer with authority to sign this Certificate, and to submit the Tender on behalf of the Tenderer;
4. For the purposes of this Certificate and the Tender, I understand that the word “competitor” shall include any individual or organization, other than the Tenderer, whether or not affiliated with the Tenderer, who:
 - a) Has been requested to submit a Tender in response to this request for tenders;
 - b) could potentially submit a tender in response to this request for tenders, based on their qualifications, abilities or experience;
5. The Tenderer discloses that [check one of the following, as applicable]:
 - a) The Tenderer has arrived at the Tender independently from, and without consultation, communication, agreement or arrangement with, any competitor;
 - b) the Tenderer has entered into consultations, communications, agreements or arrangements with one or more competitors regarding this request for tenders, and the Tenderer discloses, in the attached document(s), complete details thereof, including the names of the competitors and the nature of, and reasons for, such consultations, communications, agreements or arrangements;
6. In particular, without limiting the generality of paragraphs (5)(a) or (5)(b) above, there has been no consultation, communication, agreement or arrangement with any competitor regarding:
 - a) prices;
 - b) methods, factors or formulas used to calculate prices;
 - c) the intention or decision to submit, or not to submit, a tender; or
 - d) the submission of a tender which does not meet the specifications of the request for Tenders; except as specifically disclosed pursuant to paragraph (5)(b) above;
7. In addition, there has been no consultation, communication, agreement or arrangement with any competitor regarding the quality, quantity, specifications or delivery particulars of the works or services to which this request for tenders relates, except as specifically authorized by the procuring authority or as specifically disclosed pursuant to paragraph (5)(b) above;
8. The terms of the Tender have not been, and will not be, knowingly disclosed by the Tenderer, directly or indirectly, to any competitor, prior to the date and time of the official tender opening, or of the awarding of the Contract, whichever comes first, unless otherwise required by law or as specifically disclosed pursuant to paragraph (5)(b) above.

Name _____
Title _____
Date _____

[Name, title and signature of authorized agent of Tenderer and Date]

(c) **SELF- DECLARATION FORMS**

FORM SD1

SELF DECLARATION THAT THE PERSON/TENDERER IS NOT DEBARRED IN THE MATTER OF THE PUBLIC PROCUREMENT AND ASSET DISPOSAL ACT 2015.

I,, of Post Office Box being a resident of in the Republic of do hereby make a statement as follows: -

1. THAT I am the Company Secretary/ Chief Executive/Managing Director/Principal Officer/Direct or of (*insert name of the Company*) who is a Bidder in respect of **Tender No.** for (*insert tender title/description*) for (*insert name of the Procuring entity*) and duly authorized and competent to make this statement.
2. THAT the aforesaid Bidder, its Directors and subcontractors have not been debarred from participating in procurement proceeding under Part IV of the Act.
3. THAT what is deponed to here in above is true to the best of my knowledge, information and belief.

.....
(Title)

.....
(Signature)

.....
(Date)

Bidder Official Stamp

FORM SD2

SELF DECLARATION THAT THE PERSON/TENDERER WILL NOT ENGAGE IN ANY CORRUPT OR FRAUDULENT PRACTICE.

I,of P.O. Box being a resident of in the Republic of do hereby make a statement as follows: -

1. THAT I am the Chief Executive/Managing Director/Principal Officer/Director of (insert name of the Company) who is a Bidder in respect of **Tender No.**..... for (*insert tender title/description*) for (*insert name of the Procuring entity*) and duly authorized and competent to make this statement.
2. THAT theafore said Bidder, its servants and/oragents/subcontractorswillnotengageinanycorruptorfraudulent practice and has not been requested to pay any inducement to any member of the Board, Management, Staff and/or employees and/or agents of (*insert name of the Procuring entity*) which is the procuring entity.
3. THAT the aforesaid Bidder, its servants and/or agents /subcontractors have not offered any inducement to any member of the Board, Management, Staff and/or employees and/or agents of (*name of the procuring entity*).
4. THAT the aforesaid Bidder will not engage /has not engaged in any corrosive practice with other bidders participating in the subject tender
5. THAT what is deponed to here in above is true to the best of my knowledge information and belief.

.....
(Title)

.....
(Signature)

.....
(Date)

Bidder's Official Stamp

DECLARATION AND COMMITMENT TO THE CODE OF ETHICS

I (person) on behalf of (*Name of the Business/ Company/Firm*)
..... declare that I have read and fully understood the contents of the
Public Procurement & Asset Disposal Act, 2015, Regulations and the Code of Ethics for persons participating in
Public Procurement and Asset Disposal and my responsibilities under the Code.

I do here by commit to abide by the provisions of the Code of Ethics for persons participating in Public Procurement
and Asset Disposal.

Name of Authorized signatory.....

Sign.....

Position.....

Office address..... Telephone.....

E-mail.....

Name of the Firm/Company.....

Date.....

(Company Seal/ Rubber Stamp where applicable)

Witness

Name.....

Sign.....

Date.....

(d) APPENDIX 1 - FRAUD AND CORRUPTION

(Appendix 1 shall not be modified)

1. Purpose

1.1 The Government of Kenya's Anti-Corruption and Economic Crime laws and their sanction's policies and procedures, Public Procurement and Asset Disposal Act (*no. 33 of 2015*) and its Regulation, and any other Kenya's Acts or Regulations related to Fraud and Corruption, and similar offences, shall apply with respect to Public Procurement Processes and Contracts that are governed by the laws of Kenya.

2. Requirements

2.1 The Government of Kenya requires that all parties including Procuring Entities, Tenderers, (applicants/proposers), Consultants, Contractors and Suppliers; any Sub-contractors, Sub-consultants, Service providers or Suppliers; any Agents (whether declared or not); and any of their Personnel, involved and engaged in procurement under Kenya's Laws and Regulation, observe the highest standard of ethics during the procurement process, selection and contract execution of all contracts, and refrain from Fraud and Corruption and fully comply with Kenya's laws and Regulations as per paragraphs 1.1 above.

2.2 Kenya's public procurement and asset disposal act (*no. 33 of 2015*) under Section 66 describes rules to be followed and actions to be taken in dealing with Corrupt, Coercive, Obstructive, Collusive or Fraudulent practices, and Conflicts of Interest in procurement including consequences for offences committed. A few of the provisions noted below highlight Kenya's policy of no tolerance for such practices and behavior:

- 1) A person to whom this Act applies shall not be involved in any corrupt, coercive, obstructive, collusive or fraudulent practice; or conflicts of interest in any procurement or as set disposal proceeding;
- 2) A person referred to under subsection (1) who contravenes the provisions of that sub-section commits an offence;
- 3) Without limiting the generality of the subsection (1) and (2), the person shall be: -
 - a) disqualified from entering into a contract for a procurement or asset disposal proceeding; or
 - b) if a contract has already been entered into with the person, the contract shall be voidable;
- 4) The voiding of a contract by the procuring entity under subsection (7) does not limit any legal remedy the procuring entity may have;
- 5) An employee or agent of the procuring entity or a member of the Board or committee of the procuring entity who has a conflict of interest with respect to a procurement: -
 - a) Shall not take part in the procurement proceedings;
 - b) shall not, after a procurement contract has been entered into, take part in any decision relating to the procurement or contract; and
 - c) shall not be a subcontractor or for the tender to whom was awarded contract, or a member of the group of tenderers to whom the contract was awarded, but the subcontractor appointed shall meet all the requirements of this Act.
- 6) An employee, agent or member described in subsection (1) who refrains from doing anything prohibited under that subsection, but for that subsection, would have been within his or her duties shall disclose the conflict of interest to the procuring entity;
- 7) If a person contravenes subsection (1) with respect to a conflict of interest described in subsection (5)(a) and the contract is awarded to the person or his relative or to another person in whom one of them had a direct or indirect pecuniary interest, the contract shall be terminated and all costs incurred by the public entity shall be made good by the awarding officer. Etc.

3. In compliance with Kenya's laws, regulations and policies mentioned above, the Procuring Entity:

- a) Defines broadly, for the purposes of the above provisions, the terms set forth below as follows:
- i) “corrupt practice” is the offering, giving, receiving, or soliciting, directly or indirectly, of anything of value to influence improperly the actions of another party;
 - ii) “fraudulent practice” is any act or omission, including misrepresentation, that knowingly or recklessly misleads, or attempts to mislead, a party to obtain financial or other benefit or to avoid an obligation;
 - iii) “collusive practice” is an arrangement between two or more parties designed to achieve an improper purpose, including to influence improperly the actions of another party; “coercive practice” is impairing or harming, or threatening to impair or harm, directly or indirectly, any party or the property of the party to influence improperly the actions of a party;
 - iv) “obstructive practice” is:
 - Deliberately destroying, falsifying, altering, or concealing of evidence material to the investigation or making false statements to investigators in order to materially impede investigation by Public Procurement Regulatory Authority (PPRA) or any other appropriate authority appointed by Government of Kenya into allegations of a corrupt, fraudulent, coercive, or collusive practice; and/or threatening, harassing, or intimidating any party to prevent it from disclosing its knowledge of matters relevant to the investigation or from pursuing the investigation; or
 - acts intended to materially impede the exercise of the PPRA's or the appointed authority's inspection and audit rights provided for under paragraph 2.3 e. below.
- b) Defines more specifically, in accordance with the above procurement Act provisions set forth for fraudulent and collusive practices as follows:
- "fraudulent practice" includes a misrepresentation of fact in order to influence a procurement or disposal process or the exercise of a contract to the detriment of the procuring entity or the tenderer or the contractor, and includes collusive practices amongst tenderers prior to or after tender submission designed to establish tender prices at artificial non-competitive levels and to deprive the procuring entity of the benefits of free and open competition.
- c) Rejects a proposal for award¹ of a contract if PPRA determines that the firm or individual recommended for award, any of its personnel, or its agents, or its sub-consultants, sub-contractors, service providers, suppliers and/ or their employees, has, directly or indirectly, engaged in corrupt, fraudulent, collusive, coercive, or obstructive practices in competing for the contract in question;
 - d) Pursuant to the Kenya's above stated Acts and Regulations, may recommend to appropriate authority(ies) for sanctioning and debarment of a firm or individual, as applicable under the Acts and Regulations;
 - e) Requires that a clause be included in Tender documents and Request for Proposal documents requiring(i) Tenderers (applicants/proposers), Consultants, Contractors, and Suppliers, and their Sub-contractors, Sub-consultants, Service providers, Suppliers, Agents personnel, permit the PPRA or any other appropriate authority appointed by Government of Kenya to inspect² all accounts, records and other documents relating to the procurement process, selection and/or contract execution, and to have them audited by auditors appointed by the PPRA or any other appropriate authority appointed by Government of Kenya; and
 - f) Pursuant to Section 62 of the above Act, requires Applicants/Tenderers to submit along with their Applications/Tenders/Proposals a “Self-Declaration Form” as included in the procurement document declaring that they and all parties involved in the procurement process and contract execution have not engaged/will not engage in any corrupt or fraudulent practices.

¹For the avoidance of doubt, a party's eligibility to be awarded a contract shall include, without limitation, (i) applying for pre-qualification, expressing interest in a consultancy, and tendering, either directly or as a nominated sub-contractor, nominated consultant, nominated manufacturer or supplier, or nominated service provider, in respect of such contract, and (ii) entering into an addendum or amendment introducing a material modification to any existing contract.

²Inspections in this context usually are investigative (i.e., forensic) in nature. They involve fact-finding activities undertaken by the Investigating Authority or persons appointed by the Procuring Entity to address specific matters related to investigations/audits, such as evaluating the veracity of an allegation of possible Fraud and Corruption, through the appropriate mechanisms. Such activity includes but is not limited to: accessing and examining a firm's or individual's financial records and information, and making copies thereof as relevant; accessing and examining any other documents, data and information (whether in hard copy or electronic format) deemed relevant for the investigation/audit, and making copies thereof as relevant; interviewing staff and other relevant individuals; performing physical inspections and site visits; and obtaining third party verification of information.

2. FORM OF TENDER SECURITY- [Option 1–Demand Bank Guarantee]

Beneficiary: _____

Request forTenders No:

Date: _____

TENDER GUARANTEE No.: _____

Guarantor: _____

1. We have been informed that _____(here inafter called "the Applicant") has submitted or will submit to the Beneficiary its Tender (here inafter called" the Tender") for the execution of _____ under Request for Tenders No. _____("the ITT").
2. Furthermore, we understand that, according to the Beneficiary's conditions, Tenders must be supported by a Tender guarantee.
3. At the request of the Applicant, we, as Guarantor, hereby irrevocably undertake to pay the Beneficiary any sum or sums not exceeding in total an amount of _____(_____) upon receipt by us of the Beneficiary's complying demand, supported by the Beneficiary's statement, whether in the demand itself or a separate signed document accompanying or identifying the demand, stating that either the Applicant:
 - (a) has withdrawn its Tender during the period of Tender validity set forth in the Applicant's Letter of Tender ("the Tender Validity Period"), or any extension thereto provided by the Applicant; or
 - b) having been notified of the acceptance of its Tender by the Beneficiary during the Tender Validity Period or any extension there to provided by the Applicant, (i) has failed to execute the contract agreement, or (ii) has failed to furnish the Performance.
4. This guarantee will expire: (a) if the Applicant is the successful Tenderer, upon our receipt of copies of the contract agreement signed by the Applicant and the Performance Security and, or (b) if the Applicant is not the successful Tenderer, upon the earlier of (i) our receipt of a copy of the Beneficiary's notification to the Applicant of the results of the Tendering process; or (ii) thirty days after the end of the Tender Validity Period.
5. Consequently, any demand for payment under this guarantee must be received by us at the office indicated above onor before that date.

[signature(s)]

Note: All italicized text is for use in preparing this form and shall be deleted from the final product.

4. FORM OF TENDER SECURITY – [Option 2–Insurance Guarantee]

TENDER GUARANTEE No.: _____

1. Whereas [Name of the tenderer] (hereinafter called “the tenderer”) has submitted its tender dated [Date of submission of tender] for the [Name and/or description of the tender] (hereinafter called “the Tender”) for the execution of _____ under Request for Tenders No. _____ (“the ITT”).
2. KNOW ALL PEOPLE by these presents that WE of [Name of Insurance Company] having our registered office at (hereinafter called “the Guarantor”), are bound unto [Name of Procuring Entity] (hereinafter called “the Procuring Entity”) in the sum of (Currency and guarantee amount) for which payment well and truly to be made to the said Procuring Entity, the Guarantor binds itself, its successors and assigns, jointly and severally, firmly by these presents.

Sealed with the Common Seal of the said Guarantor this ___ day of _____ 20 __.

3. NOW, THEREFORE, THE CONDITION OF THIS OBLIGATION is such that if the Applicant:
 - a) has withdrawn its Tender during the period of Tender validity set forth in the Principal's Letter of Tender (“the Tender Validity Period”), or any extension thereto provided by the Principal; or
 - b) having been notified of the acceptance of its Tender by the Procuring Entity during the Tender Validity Period or any extension thereto provided by the Principal; (i) failed to execute the Contract agreement; or (ii) has failed to furnish the Performance Security, in accordance with the Instructions to tenderers (“ITT”) of the Procuring Entity's Tendering document.

then the guarantee undertakes to immediately pay to the Procuring Entity up to the above amount upon receipt of the Procuring Entity's first written demand, without the Procuring Entity having to substantiate its demand, provided that in its demand the Procuring Entity shall state that the demand arises from the occurrence of any of the above events, specifying which event(s) has occurred.

4. This guarantee will expire: (a) if the Applicant is the successful Tenderer, upon our receipt of copies of the contract agreement signed by the Applicant and the Performance Security and, or (b) if the Applicant is not the successful Tenderer, upon the earlier of (i) our receipt of a copy of the Beneficiary's notification to the Applicant of the results of the Tendering process; or (ii) twenty-eight days after the end of the Tender Validity Period.
5. Consequently, any demand for payment under this guarantee must be received by us at the office indicated above on or before that date.

[Date]

[Signature of the Guarantor]

[Witness]

[Seal]

Note: All italicized text is for use in preparing this form and shall be deleted from the final product.

4. FORM OF TENDER - SECURING DECLARATION

[The Bidder shall complete this Form in accordance with the instructions indicated]

Date: *[insert date (as day, month and year) of Tender Submission]*

Tender No.: *[insert number of tendering process]*

To: *[insert complete name of Purchaser]* I/We, the undersigned, declare that:

1. I/We understand that, according to your conditions, bids must be supported by a Tender-Securing Declaration.
2. I/We accept that I/we will automatically be suspended from being eligible for tendering in any contract with the Purchaser for the period of time of [insert number of months or years] starting on [insert date], if we are in breach of our obligation(s) under the bid conditions, because we—(a) have withdrawn our tender during the period of tender validity specified by us in the Tendering Data Sheet; or (b) having been notified of the acceptance of our Bid by the Purchaser during the period of bid validity, (i) fail or refuse to execute the Contract, if required, or (ii) fail or refuse to furnish the Performance Security, in accordance with the instructions to tenders.
3. I/We understand that this Tender Securing Declaration shall expire if we are not the successful Tenderer(s), upon the earlier of:
 - a) Our receipt of a copy of your notification of the name of the successful Tenderer; or
 - b) thirty days after the expiration of our Tender.
4. I/We understand that if I am /we are/ in a Joint Venture, the Tender Securing Declaration must be in the name of the Joint Venture that submits the bid, and the Joint Venture has not been legally constituted at the time of bidding, the Tender Securing Declaration shall be in the names of all future partners as named in the letter of intent.

Signed:..... Capacity/title (director or partner or sole proprietor, etc.)

Name:..... Duly authorized to sign the

bid for and on behalf of: *[insert complete name of Tenderer]*

Dated on day of, *[Insert date of signing]* Seal or stamp

5. Appendix to Tender

Schedule of Currency requirements

Summary of currencies of the Tender for _____ *[insert name of Section of the Works]*

<i>Name of currency</i>	<i>Amounts payable</i>
Local currency: _____	
Foreign currency #1: _____	
Foreign currency #2: _____	
Foreign currency #3: _____	
Provisional sums expressed in local currency _____	<i>[To be entered by the Procuring Entity]</i>

PART II - WORKS REQUIREMENTS

SECTION V - BILLS OF QUANTITIES

A. Notes and Sample Items for Preparing a Bill of Quantities

1. These Notes for Preparing a Bill of Quantities are intended only as information for the Procuring Entity or the person drafting the Tender Documents. Priced Bills of Quantities shall be part and parcel of the Contract Documents.
2. The objectives and purpose of the Bills of Quantities are to provide sufficient information on the specifications, descriptions and quantities of Works to be performed to enable tenders to be prepared efficiently and accurately and when a contract has been entered into, to provide a priced Bill of Quantities for use in the periodic valuation of Works executed. In order to attain these objectives, Works should be itemized in the Bill of Quantities insufficient detail to distinguish between the different classes of Works, or between Works of the same nature carried out in different locations or in other circumstances which may give rise to different considerations of cost. Consistent with these requirements, the layout and content of the Bill of Quantities should be as simple and clear as possible.
3. The Bills of Quantities should be divided generally into the following sections:
 - a) Preambles
 - b) Preliminary items
 - c) Work Items
 - c) Daywork Schedule; and
 - d) Provisional items
 - e) Summary.

4 NOTES TO PREPARING PREAMBLES

- 4.1 The Preambles should include only those items that constitute the cost of the works but would not be priced separately as they are expected to be included in the unit prices. Care should be taken to ensure that these items are not a repetition of the conditions of contract. The Preambles should indicate the inclusiveness of the unit prices and should state the methods of measurement that have been adopted in the preparation of the Bill of Quantities, that are to be used for the measurement of any part of the Works. The units of measurement and abbreviations should be defined and any mandatory national units defined and described. The methods of and procedure for re-measurement should be described in the Preambles.
- 4.2 Units of Measurement - The following units of measurement and abbreviations shall be used, unless other national units are mandatory in Kenya.

Unit	Abbreviation	Unit	Abbreviation
cubic meter	m ³ or cu m	millimetre	mm

- 4.3 The Bills of Quantities shall be read in conjunction with the Instructions to Tenders, General and Special Conditions of Contract, Technical Specifications, and Drawings.
- 4.4 The quantities given in the Bills of Quantities are estimated and partly provisional and are given to provide a common basis for tendering. The basis of payment will be the actual quantities of work ordered and carried out, as measured by the Contractor and verified by the Architect and valued at the rates and prices tendered in the priced

Bills of Quantities, where applicable, and otherwise at such rates and prices as the Architect may fix within the terms of the Contract.

45. The rates and prices tender in the priced Bills of Quantities shall, except in so far as it is otherwise provided under the Contract, include all Constructional Plant, labour, supervision, materials, erection, maintenance, insurance, profit, taxes, and duties, together with all general risks, liabilities, and obligations set out or implied in the Contract.
46. A rate or price shall be entered against each item in the priced Bill of Quantities, whether quantities are stated or not. The cost of Items against which the Contractor has failed to enter a rate or price shall be deemed to be covered by other rates and prices entered in the Bill of Quantities.
47. The whole cost of complying with the provisions of the Contract shall be included in the Items provided in the priced Bills of Quantities, and where no Items are provided, the cost shall be deemed to be distributed among the rates and prices entered for the related Items of Work.
48. General directions and descriptions of work and materials are not necessarily repeated nor summarized in the Bills of Quantities. References to the relevant sections of the Contract documents shall be made before entering prices against each item in the priced Bills of Quantities.
49. Provisional Sums and contingency sums included and so designated in the Bills of Quantities shall be expended in whole or in part at the direction and discretion of the Architect in accordance with Sub-Clause 13.5 and Clause 13.6 of the General Conditions of contract.
410. In preparing the Bills of Quantities, notes should be removed as they are intended to guide the person preparing the Tender Documents. The Contractor must allow in his rates for any costs associated with and complying with the requirements in the Preambles.
411. Should a tenderer/contractor not price any item in any section of the Bills of Quantities including Preliminary items, it will be assumed that he/she has spread its cost in other areas that he/she will have priced. Therefore, the item or items will be executed without any additional costs or without being treated like variations.

5. NOTES ON PREPARING BILLS OF QUANTITIES

- 5.1. The Preliminary Items should be limited to tangible items that should be priced by the tenderer, are identifiable and can be priced separately and included in the interim valuations precisely. Such items may include such items as site office, notice boards, and other temporary works, otherwise items such as security for the Works which are primarily part of the Contractor's obligations should be included in the Contractor's rates.
- 5.2. The work items in the Bills of Quantities should be grouped into sections to distinguish between those parts of the Works which by nature, location, access, timing, or any other special characteristics may give rise to different methods of construction, or phasing of the Works, or considerations of cost. Such groups could be ground excavations, structures, external works, services, etc. General items common to all parts of the Works may be grouped as a separate section in the Bill of Quantities.
- 5.3. Quantities should be computed net from the Drawings, unless directed otherwise in the Contract, and no allowance should be made for bulking, shrinkage or waste. Quantities should be rounded up where appropriate.
- 5.4. Where the measured items are deemed not to be exact because of the likelihood that the scope can change during the execution of the works, such items could be subject to re-measurement, the word "**provisional**" should be used to identify such cases. Where whole sections of the work items fall in this class, for example foundations, they should be labelled "Provisional Quantities" or "Provisional Items" so that the Tenderer/Contractor is advised up front that such items are subject to re-measurement to be done before such work is cover-up.
- 5.5. All items that have not been measured and therefore not subject to tenders pricing should be listed in the Bills of Quantities as **Provisional Sums** for particular item or class of Work, which may be subject to a nominated subcontract or separate measurements at a later date during the execution of the works. For example, if it is deemed not possible to measure electrical works before going to tender because detail designs are not ready, a provisional sum can be allowed in the Bills of Quantities for "Installation of Electrical Works" to be executed later when actual design details are completed. To the extent not covered above, there should be in the Bills of Quantities a general provision for physical and financial contingencies made as a "Provisional Sum for

Contingencies” and “Provisional Sum for Fluctuations”. The inclusion of such provisional sums often facilitates budgetary approval by avoiding the need to request periodic supplementary approvals as the future need arises.

- 5.6 Provisional sums to cover specialized works normally carried out by Nominated Sub Contractors should be avoided and instead Bills of Quantities of the specialized Works should be included as a section of the main Bills of Quantities to be priced by the Main Contractor. The Main Contractor should be required to indicate the name(s) of the specialized firms he proposes to engage to carry out the specialized Works as his approved domestic sub-contractors. Only provisional sums to cover specialized Works by statutory authorities should be included in the Bills of Quantities.
- 5.7 A Daywork Schedule should be included if the probability of unforeseen work, outside the items included in the Bill of Quantities, is relatively high. To facilitate checking by the Procuring Entity of the realism of rates quoted by the tenderers, the Daywork Schedule should normally comprise:
- i) A list of the various classes of labor, and materials for which basic.
 - ii) Daywork rates and prices for various categories of labor are to be inserted by the tenderer, together with a statement of the conditions under which the Contractor will be paid for Work executed on a Daywork basis.
 - iii) A percent a get o be entered by the tenderer agains teach basic Day work item.
 - iv) Subtotal amount for labor, materials and plant representing the Contractor's profit, overheads, supervision and other charges.
- 5.8 The Summary should contain a tabulation of the separate parts of the Bills of Quantities carried forward, with provisional sums for Daywork, Provisional sums and Contingencies, and provision for Total Costing. The last line should allow for tenderer to indicate any discounts before arriving at a total cost carried forward to the Form of Tender.

BILLS OF QUANTITIES

(a) Preambles

1. The method of measurement of completed work for payment shall be in accordance with *[insert the name of a standard reference guide, or full details of the methods to be used]*.
2. The Site is situated in *(provide full description where the site is situated, coordinates from the nearest known landmark like a town and its size)*_____It is approximately _____Kilometers from Nairobi. Access to the site shall be through_____.

Which is an existing public road. Any damage caused to the surfaces of this road shall be made good at the Contractor's expense. The Contractor shall visit the site and acquaint itself with its nature and position, the nature of the ground, substrata and other local conditions, positions of existing power, water and other services, access roads or any other limitations that might affect his cost or progress. No claim for extras shall be considered on account of lack of knowledge in this respect.

3. The Contractor shall obtain the Architect's approval on the siting of all temporary buildings, spoil heaps, temporary access path, and storage of materials. The Contractor shall also obtain the Architect approval and direction regarding the use of any materials found on the Site.
4. The drawings used in the preparation of these Bills of Quantities can be inspected at the offices of the Procuring Entity or Procuring Entity's Representative during normal working hours. Two sets of the Working Drawings shall be provided to the contractor but additional copies shall be provided at a cost to be determined by the Engineer.
5. The Contractor shall allow for the payment of all bank charges in connection with the procurement of Bank Guarantees and stamp charges in connection with this contract Agreement.
6. The Contractor shall carry out the various sections of the Works in such an order as the Architect May direct. The Procuring Entity reserves the right to occupy the Works by sections on completion provided that such occupation is considered to be both practical and reasonable and will not interfere with the Works. The Contractor shall allow any costs associated with such occupation.
7. The main Contractor will be fully responsible for paying his Sub-Contractor but the Procuring Entity reserves the right in very exceptional circumstances to make such payments direct in the interests of the project where the completion thereof might be jeopardized by any dispute or vicariousness between the Contractor and the Sub- Contractor involve.
8. The Contractor shall complete and deliver the Works in the period inserted in the Form of Tender as his time for completion of the Works from the date for Possession, to be agreed with the Engineer. The Contract Period is presumed to have been calculated making due allowance for seasonal inclement weather conditions. No claim for extension of time due to the normal in clement weather for this area shall be entertained.
9. The Contractor shall, upon receiving instructions to proceed with the Works, draw up a Programme and Progress Chart setting out the order in which the Works are to be carried out, with the appropriate dates there of. This Chart shall be agreed with the Architect and no deviation from the order set out in it will be permitted without the written consent of the Engineer. The Contractor will be responsible for arranging the above programme with all his sub-Contractors and Specialties. The Contractor shall allow in his rates for carrying out this exercise, and for updating it as required.
10. The Contractor shall submit to the Architect on the first day of each week or such longer period as the Architect from time to time direct, a Progress Report and any information for the proceeding period, showing the progress during the period and the up-to-date cumulative progression all important items of each section or portion of the Works.
11. The Contractor shall arrange for photographs of the Site to be taken by a professional photographer approved by the Engineer. The Photographs shall provide a record of the Site and adjacent areas as prior to the commencement of the Works and shall cover such portion of the works in progress and completion as the Architect shall direct. All prints shall be full plate size, unmounted, and marked on the reverse side with the date of exposure, identification reference and brief description. The copyright of all photographs shall be vested in the Procuring Entity. The negatives and four prints from each negative shall be delivered to the Architect within two weeks of exposure.

12. Figured dimensions are to be followed in preference to dimensions scaled from the Drawings, but whenever possible dimensions are to be taken on the Site or from the buildings. Before any work is commenced by Sub-Contractors or Specialist Firms, dimensions must be checked on the site comparable dimensions shown on the drawings. The Contractor shall be responsible for the accuracy of such dimensions.
13. Prior to commencement of any work the Contractor is to ascertain from the relevant Authorities the exact position, depth and level of all existing electric cables, waterpipes or other services in the area and he shall make whatever provisions may be required by the Authorities concerned for the support and protection of such services. Any damage or disturbance caused to any services shall be reported immediately to the Architect and the relevant Authority and shall be made good to their satisfaction at the Contractor's expense. Where appropriate the Contractor shall open up the ground in advance of the main work by hand digging if necessary, to locate precisely the position and details of the services which are likely to affect his operations.
14. The Contractor shall include in his prices for the transport of materials, workmen, etc./, to and from the site of the proposed works, at such hours and by such route as are permitted by the Authorities.
15. The Contractor will be required to make good, at his own expense and damage he may cause to the present road surface and pavements within or beyond the boundary of the Site, during the period of the works. All existing paths, storm water channels, etc., that may be destroyed or damaged during the progress of the Works shall be reinstated by the Contractor to the satisfaction of the Engineer.
16. The Contractor is to allow for complying with all instructions and regulations of the Police Authorities.
17. All water shall be fresh, clean and pure, free from earthly, vegetable or organic matter, acid or alkaline substance in solution. The Contractor shall provide at his own risk and cost all water for use in connection with the Works, (including works of sub-contractors). If need be, he shall make arrangements with the Local Water Authority for the installation of a separate meter for all water used by him throughout the Contract and pay all cost and fees in connection therewith. He shall also provide temporary storage tanks and tubing, etc., as may be necessary, and clear away at completion.
18. The Contractor shall provide all artificial lighting and power for his own use on the Works, (including Sub – Contractor's) including all temporary connections, wiring, fittings, etc., and clearing away on completion. The Contractor shall pay all fees and obtain all permits in connection therewith.
19. The Contractor shall constantly keep on the Works a Literate English-speaking Agent or Representative, competent and experienced in the kind of work involved, who shall give his whole time to the superintendence of the works. (Including works of sub – contractors). Such Agent or Representative shall receive on behalf of the Contractor directions and instruction from the Engineer, and such directions and instructions shall be deemed to be given to the contractor in accordance with the Conditions of Contract. The Agent shall not be replaced without the specific approval of the Engineer.
20. The Contractor shall ensure that the safety of his work people and all authorized visitors to the site are protected at all times. In particular, there shall be the proper provision of guard-rails to scaffolding, protection against falling materials, tools on site, dust, nail and other sharp objects. The site shall be kept tidy and clear of dangerous rubbish. The Architect shall be empowered to suspend work on site should it be considered this condition is not being observed and no claim arising from such suspension will be allowed.
21. The areas as available to the Contractor for workyards, offices and other facilities shall be directed by the Architect and any existing features to remain shall be protected from damage throughout the Contract Period and handed back in good condition when they are vacated at the end of the Contract. If additional areas are required, the contractor shall source them at own cost.
22. The Contractor shall give the Architect reasonable notice of the intention to set out or take levels for any part of the Works so that arrangements may be made for checking the work. The accuracy of setting out and leveling shall be within the tolerances specified in the Specifications or on the Drawings. The checking of setting out or leveling by the Architect shall not relieve the Contractor of his duties or responsibilities under the Contract.
23. The Contractor must take steps necessary to safe guard and shall be held fully responsible for any damage caused to existing and adjacent property, including buildings that are not a subject of demolition. He shall make good at his own cost damage to persons and property caused there on, and he shall indemnify the Procuring Entity against any loss or claim that may arise.

24. The Contractor shall take such steps and exercise such care and diligence as to minimize nuisance arising from dust, noise or any other cause to the occupiers of the existing and adjacent property. He must provide such temporary and special screens and tarpaulins or gummy bags, hoarding, barriers, warning signs etc. as he considers necessary and sufficient for the protection of the existing and adjacent property and or prevention of nuisance etc. as directed by Engineer.
25. The Contractors attention is drawn to the standards levy order which was amended on 15th October 1998. Legal notice No.154 of 1998. The Contractor is required to pay a monthly level of 0.2% of his factory price of construction works with effect from January 1999. Tenderer shall allow for this in the build-up of his rates.
26. The Contractor shall provide temporary sheds, offices meshrooms, sanitary, accommodation and other temporary buildings for the use of the contractor and sub-contractors, including lighting furniture equipment and attendance.
27. Contractor shall provide/build labor camp sites to be agreed with the Engineer. Labor camps shall be complete with sanitary accommodation and fencing gates.
28. The Contractor must provide the necessary toilet facilities to the requirement and satisfaction of the Health Authorities and maintain the same in a thoroughly clean and sanitary condition and pay all conservancy fees during the period of the Works and remove when no longer required.
29. The Contractor shall provide at his own risk and cost all watching and lighting as necessary to safeguard the Works, Plant and materials against damage and theft.
30. The Contractor shall provide all necessary hoists, tackle, plant, equipment, vehicles, tools and appliances of every description for the due and satisfactory completion of the Works and shall remove the same on completion. All such plant, tools and equipment shall comply with all regulations in force throughout the period of the Contract and shall be altered or adopted during the Contract period as may be necessary to comply with any amendments in or additions to such regulations.
31. Provide, erect and maintain all necessary scaffolding, sufficiently strong and efficient for the due performance of the works, including Sub-Contract Works, provide special scaffolding as required by Sub-Contractors, alter and adopt all scaffolding as and when required during the Works, and remove on completion. No scaffolding is measured here in after and the Contractor must allow in his rates for this.
32. The Contractor shall take all necessary precautions such as temporary fencing, hoarding fans, planked footways, guard-rails gantries screen, etc., for the safe custody of the Works, materials and public protection and adjacent properties.
33. Cover up all and protect from damage, including damage from inclement weather, all finished work and unfixed materials, including that of Sub-Contractors, etc., to the satisfaction of the Architect until the completion of the Contract.
34. The Contractor shall, after completion of the works, at his own expense, remove and clear away all surplus excavated demolition materials, plant, rubbish and unused materials and shall leave the whole of the Site and Works in a clean and tidy state to the satisfaction of the Engineer, sheds, camps, etc. Particular care shall be taken to leave clean all floors and windows and to remove all paint and cement all rubbish and dirt as it accumulates. The Contractor is to find his own dump and shall pay all charges in connection therewith.
35. Concrete test cubes shall be prepared in a set of three, as described including testing fees, labor and materials, making molds, transport, handling, etc. Allow in your rates for making at least four cubes on each occasion, from different batches; the concrete being taken from the point of deposit.
36. The Contractor shall furnish at the earliest possible opportunity before work commences, and at his own cost, any samples of materials and workmanship that may be called for by the Architect for the approval or rejection, and any further samples in the case of rejection, until such samples are approved by the Engineer. Such samples, when approved, shall be the minimum standard for the work to which they apply. The procedure for submitting samples of materials for testing or approval and the method of marking for identification shall be as laid down by the Engineer. The Contractor shall allow in his Tender for such samples and tests, including those in connection with his Sub-Contractors work.

37. The Contractor's attention is drawn to the Finance Bill of the year 2000/2001 on withholding tax on contractual payment section 35(7)(i)(ii) which became effective on 1st July 2000. A 3% withholding tax will be applicable to all interim payments exceeding Kshs..... for work done in respect of building or civil works. The contractor shall allow for any costs arising resulting there from in the build-up of rates.
38. Blasting will only be allowed with the express permission of the Architect in writing. All blasting operations shall be carried out at the Contractor's sole risk and cost, in accordance with any Government regulations in force for the time being, and any special regulations laid down by the Architect governing the use and storage of explosives.
39. The National Construction Authority is a state corporation established under the national construction authority Act No.14 of 2011. The broad Mandate of the Authority is to over see the construction industry and coordinate its development. The National Construction Authority Regulations 2014 with an effective date of 6th June 2014, regulation 25, - Allow 0.5% of the tender sum/contract sum for construction levy.
40. The Contractor attention is drawn to Finance Bill of 1993 where VAT was introduced in all contracts for construction services. The tenderer is also drawn to VAT Act Cap 476 clause 19(9). The tenderer must allow for VAT 1.19 as instructed else where.
41. The contractor shall allow and pay for all insurance to cover risks and indemnities required Items 17 and 18 of the Conditions of contract and also specified in the Special Conditions of Contract.

BILL NO. 1 - PRELIMINARY ITEMS

ITEM No.	DESCRIPTION	AMOUNT
1.	<p>The Contractor shall provide, or erect and maintain an approved lock-up office for the sole use of the Architect and his own site staff. The office, which will have a total floor area of not less than.....square metres, will be divided into two separate interconnected offices. Services to be provided shall include a telephone, water sanitary and electrical supply and drainage. The offices shall be supplied with furniture and equipment that shall include:</p> <p>4 No. desks with chairs; 1 No. large table with sufficient number of chairs; drawing table along the full length of one side with plan drawers and drawing stools: 4 No. waste paper baskets: sufficient number of pin boards: and any additional furniture and fittings as may reasonably be required during the Contract period. The Contractor shall provide the Architect and site staff with computer sets or laptops, printers and telephones all that are necessary for project use.</p> <p>The office furniture and equipment shall all be to the approval of the Engineer. The Contractor shall also provide all labor, equipment and consumable stores equipment throughout the currency of the contract.</p>	
2	<p>[OPTIONAL] Contractor shall provide a house for Engineers site agent, which shall be one bedroomed temporary house with a sitting room, toilet, bathroom and a kitchen complete with electrical and sanitary installations and provide maintenance and paying of bills of water and electricity up to and including end of the contract period.</p>	
3	<p>Provide a signboard notless than_____square meters in size of a design type, and with lettering and coloring and in a position approved by the Engineer. The signboard shall be for the display of the Main Contractor's name and the names of all his Sub-Contractors, with the Procuring Entity's name painted thereon. All Consultants names be printed in letters not exceeding 50 mm high. No other signboard or advertising shall be allowed. The signboard shall be fully maintained during the Contract Period and shall be pulled down and removed at the end of the contract.</p>	
4	Add others (if any)	
5		
6		
TOTAL CARRIED TO GRAND SUMMARY		

BILL NO. 2: WORK ITEMS

(organized appropriately into work sections, such as foundations, walls/structure, finishes, doors and windows, mechanical installations. etc.

Bill No 2 - *(Name of Section e.g. Foundations).*

Itemno.	Description	Unit	Quantity	Rate	Amount
Total for Bill No. 2 (carried forward to Summary, p.____)					

Bill No. 3: Schedule of Daywork Rates - Labor

<i>Itemno.</i>	<i>Description</i>	<i>Unit</i>	<i>Nominal quantity</i>	<i>Rate</i>	<i>Amount</i>
	Subtotal				
	Allow ___ percent ^a of Subtotal for Contractor's overhead, profit, etc., in accordance with paragraph 3 (b) above.				

a. To be entered by the Tenderer.

Bill No. 4: Schedule of Daywork Rates - Materials

<i>Itemno.</i>	<i>Description</i>	<i>Unit</i>	<i>Nominal quantity</i>	<i>Rate</i>	<i>Extended amount</i>
	Subtotal				
	Allow ____ percent a. of Subtotal for Contractor's overhead, profit, etc., in accordance with paragraph 4 (b) above.				

a. To be entered by the Tenderer.

Bill No. 5: Schedule of Daywork Rates - Contractor's Equipment

<i>Itemno.</i>	<i>Description</i>	<i>Nominal quantity (hours)</i>	<i>Basic hourly rental rate</i>	<i>Extended amount</i>
	Allow ____ percent ^a of Subtotal for Contractor's overhead, profit, etc., in accordance with paragraph 5 above.			
Total for Daywork: Contractor's Equipment (carried forward to Daywork Summary, p. ____)				

a. To be entered by the Tenderer.

Bill No. 6: Daywork Summary

	<i>Amount^a</i>	<i>% Foreign</i>	<i>Currency</i>
1.Total for Daywork:Labor			
2.Total for Daywork:Materials			
3.Total for Daywork:Contractor's Equipment			
Total for Daywork (Provisional Sum) (carried forward to Summary of Bills of Quantities, p. ____)			

Bill No. 7: Provisional Sums

<i>Billno.</i>	<i>Itemno.</i>	<i>Description</i>	<i>Amount</i>
1			
2			
3			
4			
etc.			
Total for Specified Provisional Sums (carried forward to Grand Summary)			

GRAND SUMMARY

SUMMARY ITEMS	<i>Page</i>	<i>Amount</i>
BillNo.1:Preliminary Items		
BillNo.2:Work Items		
Bill No 3: Daywork Summary		
Bill No 4: Provisional Sums		
Subtotal of Bills No 1-4		
Allow for any Discounts ⁱ		
TOTAL TENDER PRICE Carried forward to Form of Tender		

(i) If a percentage used, it should be indicated on which Bill No. items but on Bill No.4 – Provisional Sums.

SECTION VI - SPECIFICATIONS

Notes for preparing Specifications

1. Specifications must be drafted to present a clear and precise statement of the required standards of materials, and workmanship for tenderers to respond realistically and competitively to the requirements of the Procuring Entity and ensure responsiveness of tenders. The Specifications should require that all materials, plant, and other supplies to be permanently incorporated in the Works be new, unused, of the most recent or current models, and incorporating all recent improvements in design and materials unless provided otherwise in the Contract. Where the Contractor is responsible for the design of any part of the permanent Works, the extent of his obligations must be stated.
2. Specifications from previous similar projects are useful and may not be necessary to re-write specifications for every Works Contract.
3. There are considerable advantages in standardizing **General Specifications** for repetitive Works in recognized public sectors, such as high ways, urban housing, irrigation and water supply. The General Specifications should cover all classes of workmanship, materials and equipment commonly involved in constructions, although not necessarily to be used in a particular works contract. Deletions or addenda should then adapt the General Specifications to the particular Works.
4. Care must be taken in drafting Specifications to ensure they are not restrictive. In the Specifications of standards for materials, plant and workmanship, existing Kenya Standards should be used as much as possible, otherwise recognized international standards may also be used.
5. The Procuring Entity should decide whether technical solutions to specified parts of the Works are to be permitted. Alternatives are appropriate in cases where obvious (and potentially less costly) alternatives are possible to the technical solutions indicated in tender documents for certain elements of the Works, taking into consideration the comparative specialized advantage of potential tenderers.
6. The Procuring Entity should provide a description of the selected parts of the Works with appropriate reference to Drawings, Specifications, Bills of Quantities, and Design or Performance criteria, stating that the alternative solutions shall be at least structurally and functionally equivalent to the basic design parameters and Specifications.
7. Such alternative solutions shall be accompanied by all information necessary for a complete evaluation by the Procuring Entity, including drawings, design calculations, technical specifications, breakdown of prices, proposed construction methodology, and other relevant details. Technical alternatives permitted in this manner shall be considered by the Procuring Entity each on its own merits and independently of whether the tenderer has priced the item as described in the Procuring Entity's design included with the tender documents.

SECTION VII - DRAWINGS

DRAWING TITLE	DRAWING NO.
As shall be issued by the Project Architect	

NOTE:

Tenderers are advised to inspect the electrical drawings at the office of the Regional Works Officer –State Department of Public Works Embu during normal working hours.

The drawings shall however be availed, on award of the tender, to the sub-contractor.

PART III - THE CONDITIONS OF CONTRACT AND CONTRACT

SECTION VIII - GENERAL CONDITIONS OF CONTRACT (GCC)

[Name of Procuring Entity]

[Name of Contract]

[Architect Name and Address]

General Conditions of Contract

1 GENERAL PROVISIONS

1.1 Definitions

In this Contract, except where context otherwise requires, the following terms shall be interpreted as indicated below. Words indicating persons or parties include corporations and other legal entities, except where the context requires otherwise.

“Accepted Contract Amount” means the amount accepted in the Letter of Acceptance for the execution and completion of the Works and the remedying of any defects.

“Base Date” means a date 30 day prior to the submission of tenders.

“Bill of Quantities” means the priced and completed Bill of Quantities forming part of the tender.

“Completion Date” means the date of completion of the Works as certified by the Engineer.

“Contract Price” means the price defined in the contract and there after as adjusted in accordance with the provisions of the Contract.

“Contract” means the agreement entered into between the Procuring Entity and the Contractor as recorded in the Agreement Form and signed by the parties including all attachments and appendices thereto and all documents incorporated by reference therein to execute, complete, and maintain the Works.

“Contractor's Documents” means the calculations, computer programs and other software, progress reports, drawings, manuals, models and other documents of a technical nature (if any) supplied by the Contractor under the Contract.

“Contractor's Equipment” means all apparatus, machinery, vehicles and other things required for the execution and completion of the Works and the remedying of any defects. However, Contractor's Equipment excludes Temporary Works, Procuring Entity's Equipment (if any), Plant, Materials and any other things intended to form or forming part of the Permanent Works.

“Contractor's Personnel” means the Contractor's Representative and all personnel whom the Contractor utilizes on Site, who may include the staff, labor and other employees of the Contractor and of each Subcontractor; and any other personnel assisting the Contractor in the execution of the Works.

“Contractor's Representative” means the person named by the Contractor in the Contractor appointed from time to time by the Contractor who acts on behalf of the Contractor.

“Contractor” means the person(s) named as contractor in the Form of Tender accepted by the Procuring Entity.

“Cost” means expenditure reasonably incurred (or to be incurred) by the Contractor, whether on or off the Site, including overhead and similar charges, but does not include profit.

“Day” means a calendar day and **“year”** means 365 days.

“Dayworks” means Work inputs subject to payment on a time basis for labour and the associated materials and plant.

“Defect” means any part of the Works not completed in accordance with the Contract.

“Defects Liability Certificate” means the certificate issued by Architect upon correction of defects by the Contractor.

“Defects Liability Period” means the period named in the Special Conditions of Contract and calculated from the Completion Date, within which the contractor is liable for any defects that may develop in the handed over works.

“Defects Notification Period” means the period for notifying defects in the Works or a Section (as the case may be) under Sub-Clause 11.1 [Completion of Outstanding Work and Remedying Defects], which extends over the days stated in the Special Conditions of Contract.

“Drawings” means the drawings of the Works, as included in the Contract, and any additional and modified drawings issued by (or on behalf of) the Procuring Entity in accordance with the Contract.

“Final Payment Certificate” means the payment certificate issued under Sub-Clause 14.13 [Issue of Final Payment Certificate].

“Final Statement” means the statement defined in Sub-Clause 14.11 [Application for Final Payment Certificate].

“Force Majeure” is defined in Clause 19 [Force Majeure].

“Foreign Currency” means a currency of another country (not Kenya) in which part (or all) of the Contract Price is payable, but not the Local Currency.

“Goods” means Contractor's Equipment, Materials, Plant and Temporary Works, or any of them as appropriate.

“Interim Payment Certificate” means a payment certificate issued under Clause 14 [Contract Price and Payment], other than the Final Payment Certificate.

“Laws” means all national legislation, statutes, ordinances, and regulations and by-laws of any legally constituted public authority.

“Letter of Acceptance” means the letter of formal acceptance of a tender, signed by Procuring Entity, including any annexed memoranda comprising agreements between and signed by both Parties.

“Local Currency” means the currency of Kenya.

“Materials” means things of all kinds (other than Plant) intended to form or forming part of the Permanent Works, including the supply-only materials (if any) to be supplied by the Contractor under the Contract.

“Notice of Dissatisfaction” means the notice given by either Party to the other under Sub-Clause 20.3 indicating its dissatisfaction and intention to commence arbitration.

“Special Conditions of Contract” means the pages completed by the Procuring Entity entitled Special Conditions of Contract which constitute Part A of the Special Conditions.

“Party” means the Procuring Entity or the Contractor, as the context requires.

“Payment Certificate” means a payment certificate issued under Clause 14 [Contract Price and Payment].

“Performance Certificate” means the certificate issued under Sub-Clause 11.9 [Performance Certificate].

“Performance Security” means the security (or securities, if any) under Sub-Clause 4.2 [Performance Security].

“Permanent Works” means the permanent works to be executed by the Contractor under the Contract.

“Plant” means the apparatus, machinery and other equipment intended to form or forming part of the Permanent Works, including vehicles purchased for the Procuring Entity and relating to the construction or operation of the Works.

“Procuring Entity's Equipment” means the apparatus, machinery and vehicles (if any) made available by the

Procuring Entity for the use of the Contract or in the execution of the Works, as stated in the Specification; but does not include Plant which has not been taken over by the Procuring Entity.

“Procuring Entity's Personnel” means the Engineer, the Engineer, the assistants and all other staff, labor and other employees of the Architect and of the Procuring Entity; and any other personnel notified to the Contractor, by the Procuring Entity or the Engineer, as Procuring Entity's Personnel.

“Procuring Entity” means the Entity named in the Special Conditions of Contract.

“Engineer” is the person named in the Appendix to Conditions of Contract (or any other competent person appointed by the Procuring Entity and notified to the Contractor, to act in replacement of the Engineer) who is responsible for supervising the execution of the Works and administering the Contract and shall be an “Architect” or a “Quantity Surveyor” registered under the Architects and Quantity Surveyors Act Cap 525 or an “Engineer” registered under Engineers Registration Act Cap 530.

“Engineer” means the person appointed by the Procuring Entity to act as the Architect for the purposes of the Contract and named in the Special Conditions of Contract, or other person appointed from time to time by the Procuring Entity and notified to the Contractor

“Provisional Sum” means a sum (if any) which is specified in the Contract as a provisional sum, for the execution of any part of the Works or for the supply of Plant, Materials or services under Sub-Clause 13.5 [Provisional Sums].

“Retention Money” means the accumulated retention moneys which the Procuring Entity retains under Sub-Clause 14.3 [Application for Interim Payment Certificates] and pays under Sub-Clause 14.9 [Payment of Retention Money].

“Schedules” means the document(s) entitled schedules, completed by the Contractor and submitted with the Form of Tender, as included in the Contract.

“Section” means a part of the Works specified in the Special Conditions of Contract as a Section (if any)

“Site Investigation Reports” are those reports that may be included in the tendering documents which a ref actual and interpretative about the surface and sub-surface condition sat the Site.

“Site” means the places where the Permanent Works are to be executed, including storage and working areas, and to which Plant and Materials are to be delivered, and any other places as may be specified in the Contract as forming part of the Site.

“Specification” means the document entitled specification, as included in the Contract, and any additions and modifications to the specification in accordance with the Contract. Such document specifies the Works.

“Start Date” or “Commencement Date” is the latest date when the Contractor shall commence execution of the Works. It does not necessarily coincide with the Site possession date(s).

“Statement” means a statement submitted by the Contractor as part of an application, under Clause 14 [Contract Price and Payment], for a payment certificate.

“Subcontractor” means any person named in the Contract as a subcontractor, or any person appointed as a subcontractor, for a part of the Works.

“Taking-Over Certificate” means a certificate issued under Clause 10 [Procuring Entity's Taking Over].

“Temporary Works” means all temporary works of every kind (other than Contractor's Equipment) required on Site for the execution and completion of the Permanent Works and the remedying of any defects.

“Temporary works” means works designed, constructed, installed, and removed by the Contractor which are needed for construction or installation of the Works.

“Tender” means the Form of Tender and all other documents which the Contractor submitted with the Form of Tender, as included in the Contract.

“Tests after Completion” means the tests (if any) which are specified in the Contract and which are carried out in

accordance with the Specification after the Works or a Section (as the case may be) are taken over by the Procuring Entity.

“**Testson Completion**” means the tests which are specified in the Contractor agreed by both Parties or instructed as a Variation, and which are carried out under Clause 9 [Tests on Completion] before the Works or a Section (as the case may be) are taken over by the Procuring Entity.

“**Time for Completion**” means the time for completing the Works or a Section (as the case may be) as stated in the Special Conditions of Contract (with any extension calculated from the Commencement Date.

“**Unforeseeable**” means not reasonably foreseeable by an experienced contractor by the Base Date.

“**Variation**” means any change to the Works, which is instructed or approved as a variation under Clause 13 [Variations and Adjustments].

“**Works**” means the items the Procuring Entity requires the Contractor to undertake as defined in the Appendix to Conditions of Contract. “**Works**” **may** also mean the Permanent Works and the Temporary Works, or either of them as appropriate.

1.2 Interpretation

In the Contract, except where the context requires otherwise:

- a) Words indicating one gender include all genders;
- b) words indicating the singular also include the plural and words indicating the plural also include the singular;
- c) provisions including the word “agree”, “agreed” or “agreement” require the agreement to be recorded in writing;
- d) “written” or “in writing” means hand-written, type-written, printed or electronically made, and resulting in a permanent record; and

The marginal words and other headings shall not be taken into consideration in the interpretation of these Conditions.

1.3 Communications

1.3.1 Wherever these Conditions provide for the giving or issuing of approvals, certificates, consents, determinations, notices, requests and discharges, these communications shall be:

- a) In writing and delivered by hand (against receipt), sent by mail or courier, or transmitted using any of the agreed systems of electronic transmission as stated in the Special Conditions of Contract; and
- b) delivered, sent, or transmitted to the address for the recipient's communications as stated in the Special Conditions of Contract. However:
 - i) if the recipient gives notice of another address, communications shall thereafter be delivered accordingly; and
 - ii) if the recipient has not stated otherwise when requesting an approval or consent, it may be sent to the address from which the request was issued.

1.3.2 Approvals, certificates, consents and determinations shall not be unreasonably withheld or delayed. When a certificate is issued to a Party, the certifier shall send a copy to the other Party. When a notice is issued to a Party, by the other Party or the Engineer, a copy shall be sent to the Architect or the other Party, as the case may be.

1.4 Law and Language

1.4.1 The Contract shall be governed by the laws of **Kenya**.

1.4.2 The ruling language of the Contract shall be **English**.

1.5 Priority of Documents

The documents forming the Contract are to be taken as mutually explanatory of one another. For the purposes of interpretation, the priority of the documents shall be in accordance with the following sequence:

- a) The Contract Agreement,
- b) The Letter of Acceptance,
- c) The Special Conditions – Part A,
- d) the Special Conditions – Part B
- e) the General Conditions of Contract
- f) the Form of Tender,
- g) the Specifications and Bills of Quantities
- h) the Drawings, and
- i) the Schedules and any other documents forming part of the Contract.

If an ambiguity or discrepancy is found in the documents, the Architect shall issue any necessary clarification or instruction.

1.6 Contract Agreement

The Parties shall enter into a Contract Agreement within 14 days after the Contractor receives the Contract Agreement, unless the Special Conditions establish otherwise. The Contract Agreement shall be based upon the form annexed to the Special Conditions. The costs of stamp duties and similar charges (if any) imposed by law in connection with entry into the Contract Agreement shall be borne by the Procuring Entity.

1.7 Assignment

The Contractor shall not assign the whole or any part of the Contract or any benefit or interest in or under the Contract. However, the contractor:

- a) May assign the whole or any part with the prior consent of the Procuring Entity, and
- b) may, as security in favor of a bank or financial institution, assign its right to moneys due, or to become due, under the Contract.

1.8 Care and Supply of Documents

- 1.81 The Specifications and Drawings shall be in the custody and care of the Procuring Entity. Unless otherwise stated in the Contract, two copies of the Contract and of each subsequent Drawings and Bills of Quantities shall be supplied to the Contractor, who may make or request further copies at the cost of the Contractor.
- 1.82 Each of the Contractor's Documents shall be in the custody and care of the Contractor, unless and until taken over by the Procuring Entity. Unless otherwise stated in the Contract, the Contractor shall supply to the Architect two copies of each of the Contractor's Documents.
- 1.83 The Contractor shall keep, on the Site, a copy of the Contract, publications named in the Specification, the Contractor's Documents (if any), the Drawings and Variations and other communications given under the Contract. The Procuring Entity's Personnel shall have the right of access to all these documents at all reasonable times.
- 1.84 If a Party becomes aware of an error or defect in a document which was prepared for use in executing the Works, the Party shall promptly give notice to the other Party of such error or defect.

1.9 Timely provision of Drawings or Instructions

- 1.91 The Contractor shall give notice to the Architect whenever the Works are likely to be delayed or disrupted if any necessary drawing or instruction is not issued to the Contractor within a particular time, which shall be reasonable. The notice shall include details of the necessary drawing or instruction, details of why and by when it should be issued, and the nature and amount of the delay or disruption likely to be suffered if it is late.
- 1.92 If the Contractor suffers delay and/or incurs Cost as a result of a failure of the Architect to issue the notified drawing or instruction within a time which is reasonable and is specified in the notice with supporting details, the Contractor shall give a further notice to the Architect and shall be entitled subject to Sub-Clause 20.1 [Contractor's Claims] to:
 - a) an extension of time for any such delay, if completion is or will be delayed, under Sub-Clause 8.4 [Extension of Time for Completion], and

b) payment of any other associated costs accrued, which shall be included in the Contract Price.

1.93 After receiving this further notice, the Architect shall proceed in accordance with Sub-Clause 3.5 [Determinations] to agree or determine these matters.

1.94 However, if and to the extent that the Architect failure was caused by any error or delay by the Contractor, including an error in, or delay in the submission of, any of the Contractor's Documents, the Contractor shall not be entitled to such extension of time, or costs accrued.

1.10 Procuring Entity's Use of Contractor's Documents

1.101 As agreed between the Parties, the Contractor shall retain the copyright and other intellectual property rights in the Contractor's Documents and other design documents made by (or on behalf of) the Contractor.

1.102 The Contractor shall be deemed (by signing the Contract) to give to the Procuring Entity a non-terminable transferable non-exclusive royalty-free license to copy, use and communicate the Contractor's Documents, including making and using modifications of them. This license shall:

- a) apply throughout the actual or intended working life (whichever is longer) of the relevant parts of the Works,
- b) entitle any person in proper possession of the relevant part of the Works to copy, use and communicate the Contractor's Documents for the purposes of completing, operating, maintaining, altering, adjusting, repairing and demolishing the Works, and
- c) in the case of Contractor's Documents which are in the form of computer programs and other software, permit their use on any computer on the Site and other places as envisaged by the Contract, including replacements of any computers supplied by the Contractor.

1.103 The Contractor's Documents and other design documents made by (or on behalf of) the Contractor shall not, without the Contractor's consent, be used, copied or communicated to a third party by (or on behalf of) the Procuring Entity for purposes other than those permitted under Sub-Clause 1.10.2.

1.11 Contractor's Use of Procuring Entity's Documents

As agreed between the Parties, the Procuring Entity shall retain the copyright and other intellectual property rights in the Specification, the Drawings and other documents made by (or on behalf of) the Procuring Entity. The Contractor may, at his cost, copy, use, and obtain communication of these documents for the purposes of the Contract. They shall not, without the Procuring Entity's consent, be copied, used or communicated to a third party by the Contractor, except as necessary for the purposes of the Contract.

1.12 Confidential Details

1.121 The Contractor's and the Procuring Entity's Personnel shall ensure confidentiality at all times. The confidentiality shall survive termination or completion of the contract. They shall disclose all such confidential and other information as may be reasonably required in order to verify compliance with the Contract and allow its proper implementation.

1.122 The Contractor's and the Procuring Entity's Personnel shall also treat the details of the Contract as private and confidential, except to the extent necessary to carry out their respective obligations under the Contract or to comply with applicable Laws. Each of them shall not publish or disclose any particulars of the Works prepared by the other Party without the previous agreement of the other Party. However, the Contractor shall be permitted to disclose any publicly available information, or information otherwise required to establish his qualifications to compete for other projects.

1.13 Compliance with Laws

The Contractor shall, in performing the Contract, comply with applicable Laws. Unless otherwise stated in the Special Conditions of Contract:

- a) The Procuring Entity shall have obtained (or shall obtain) the planning, zoning, building permit or similar permission for the Permanent Works, and any other permissions described in the Specifications as having been (or to be) obtained by the Procuring Entity; and the Procuring Entity shall indemnify and hold the Contractor harmless against and from the consequences of any failure to do so; and

- b) the Contractor shall give all notices, pay all taxes, duties and fees, and obtain all permits, licenses and approvals, as required by the Laws in relation to the execution and completion of the Works and the remedying of any defects; and the Contractor shall indemnify and hold the Procuring Entity harmless against and from the consequences of any failure to do so, unless the Contractor is impeded to accomplish these actions and shows evidence of its diligence.

1.14 Joint and Several Liability

If the Contractor constitutes (under applicable Laws) a joint venture, consortium or other unincorporated grouping of two or more persons:

- a) These persons shall be deemed to be jointly and severally liable to the Procuring Entity for the performance of the Contract;
- b) these persons shall notify the Procuring Entity of their leader who shall have authority to bind the Contractor and each of these persons; and
- c) the Contractor shall not alter its composition or legal status without the prior consent of the Procuring Entity.

1.15 Inspections and Audit by the Procuring Entity

Pursuant to paragraph 2.2(e). of Appendix B to the General Conditions, the Contractor shall permit and shall cause its subcontractors and sub-consultants to permit, the Public Procurement Regulatory Authority, Procuring Entity and/or persons appointed or designated by the Government of Kenya to inspect the Site and/or the accounts and records relating to the procurement process, selection and/or contract execution, and to have such accounts and records audited by auditors appointed by the Procuring Entity if requested by the Procuring Entity. The Contractor's and its Subcontractors' and sub-consultants' attention is drawn to Sub-Clause 15.6 (Fraud and Corruption) which provides, inter alia, that acts intended to materially impede the exercise of the Procuring Entity's inspection and audit rights constitute a prohibited practice subject to contract termination (as well as to a determination of ineligibility pursuant to the Procuring Entity's prevailing sanctions procedures).

2 THE PROCURING ENTITY

2.1 Right of Access to the Site

- 2.1.1 The Procuring Entity shall give the Contractor right of access to, and possession of, all parts of the Site within the time (or times) stated in the **Special Conditions of Contract**. The right and possession may not be exclusive to the Contractor. If, under the Contract, the Procuring Entity is required to give (to the Contractor) possession of any foundation, structure, plant or means of access, the Procuring Entity shall do so in the time and manner stated in the Specification. However, the Procuring Entity may withhold any such right or possession until the Performance Security has been received.
- 2.1.2 If no such time is stated in the Special Conditions of Contract, the Procuring Entity shall give the Contractor right of access to, and possession of, the Site within such times as required to enable the Contractor to proceed without disruption in accordance with the programme submitted under Sub-Clause 8.3 [Programme].
- 2.1.3 If the Contractor suffers delay and/or incurs Cost as a result of a failure by the Procuring Entity to give any such right or possession within such time, the Contractor shall give notice to the Architect and shall be entitled subject to Sub-Clause 20.1 [Contractor's Claims] to:
 - a) an extension of time for any such delay, if completion is or will be delayed, under Sub-Clause 8.4 [Extension of Time for Completion], and
 - b) payment of any such Cost-plus profit, which shall be included in the Contract Price.
- 2.1.4 After receiving this notice, the Architect shall proceed in accordance with Sub-Clause 3.5 [Determinations] to agree or determine these matters.
- 2.1.5 However, if and to the extent that the Procuring Entity's failure was caused by any error or delay by the Contractor, including an error in, or delay in the submission of, any of the Contractor's Documents, the Contractor shall not be entitled to such extension of time, Cost or profit.

22 Permits, Licenses or Approvals

22.1 The Procuring Entity shall provide, at the request of the Contractor, such reasonable assistance as to allow the Contractor to obtain properly:

- a) Copies of the Laws of Kenya which are relevant to the Contract but are not readily available, and
- b) any permits, licenses or approvals required by the Laws of Kenya:
 - i) which the Contractor is required to obtain under Sub-Clause 1.13 [Compliance with Laws],
 - ii) for the delivery of Goods, including clearance through customs, and
 - iii) for the export of Contractor's Equipment when it is removed from the Site.

23 Procuring Entity's Personnel

The Procuring Entity shall be responsible for ensuring that the Procuring Entity's Personnel and the Procuring Entity's other contractors on the Site:

- a) co-operate with the Contractor's efforts under Sub-Clause 4.6 [Co-operation], and
- b) take actions similar to those which the Contractor is required to take under sub-paragraphs (a), (b) and (c) of Sub-Clause 4.8 [Safety Procedures] and under Sub-Clause 4.18 [Protection of the Environment].

24 Procuring Entity's Financial Arrangements

The Procuring Entity shall make and maintain all necessary financial arrangements which will enable the Procuring Entity to pay the Contract Price punctually (as estimated at that time) in accordance with Clause 14 [Contract Price and Payment].

3 THE ENGINEER

3.1 Architect Duties and Authority

3.1.1 The Procuring Entity shall appoint the Architect who shall carry out the duties as signed to him in the Contract. The Architect staff shall include suitably qualified Assistants and other professionals who are competent to carry out these duties. The Architect Name and Address shall be provided in the **Special Conditions of Contract**.

3.1.2 The Architect shall have no authority to amend the Contract.

3.1.3 The Architect May exercise the authority attributable to the Architect as specified in or necessarily to be implied from the Contract. If the Architect is required to obtain the approval of the Procuring Entity before exercising a specified authority, the requirements shall be as stated in the **Special Conditions of Contract**. The Procuring Entity shall promptly inform the Contractor of any change to the authority attributed to the Engineer.

3.1.4 However, whenever the Architect exercises a specified authority for which the Procuring Entity's approval is required, then (for the purposes of the Contract) the contractor shall require the Architect to provide evidence of such approval before complying with the instruction.

3.1.5 Except as otherwise stated in these Conditions:

- a) Whenever carrying out duties or exercising authority, specified in or implied by the Contract, the Architect shall be deemed to act for the Procuring Entity;
- b) the Architect has no authority to relieve either Party of any duties, obligations or responsibilities under the Contract;
- c) any approval, check, certificate, consent, examination, inspection, instruction, notice, proposal, request, test, or similar act by the Architect (including absence of disapproval) shall not relieve the Contractor from any responsibility he has under the Contract, including responsibility for errors, omissions, discrepancies and non-compliances; and
- d) any act by the Architect in response to a Contractor's request shall be notified in writing to the Contractor within 14 days of receipt.

3.1.6 The following provisions shall apply:

The Architect shall obtain the specific approval of the Procuring Entity before taking action under the following Sub-Clauses of these Conditions:

- a) Sub-Clause 4.12: agreeing or determining an extension of time and/or additional cost.
 - b) Sub-Clause 13.1: instructing a Variation, except;
 - i) In an emergency situation as determined by the Engineer, or
 - ii) If such a Variation would increase the Accepted Contract Amount by less than the percentage specified in the **Special Conditions of Contract**.
 - c) Sub-Clause 13.3: Approving a proposal for Variation submitted by the Contractor in accordance with Sub Clause 13.1 or 13.2.
 - d) Sub-Clause 13.4: Specifying the amount payable in each of the applicable three currencies.
- 3.1.7 Notwithstanding the obligation, as set out above, to obtain approval, if, in the opinion of the Engineer, an emergency occurs affecting the safety of life or of the Works or of adjoining property, he may, without relieving the Contractor of any of his duties and responsibility under the Contract, instruct the Contractor to execute all such work or to do all such things as may, in the opinion of the Engineer, be necessary to abate or reduce the risk. The Contractor shall forth with comply, despite the absence of approval of the Procuring Entity, with any such instruction of the Engineer. The Architect shall determine an addition to the Contract Price, in respect of such instruction, in accordance with Clause 13 and shall notify the Contractor accordingly, with a copy to the Procuring Entity.

32 Delegation by the Engineer

- 3.2.1 The Architect may from time to time assign duties and delegate authority to assistants and may also revoke such assignment or delegation. These assistants may include a resident Engineer, and/or independent inspectors appointed to inspect and/ or test items of Plant and/or Materials. The assignment, delegation or revocation shall be in writing and shall not take effect until copies have been received by both Parties. However, unless otherwise agreed by both Parties, the Architect shall not delegate the authority to determine any matter in accordance with Sub-Clause 3.5 [Determinations].
- 3.2.2 Each assistant, to whom duties have been assigned or authority has been delegated, shall only be authorized to issue instructions to the Contractor to the extent defined by the delegation. Any approval, check, certificate, consent, examination, inspection, instruction, notice, proposal, request, test, or similar act by an assistant, in accordance with the delegation, shall have the same effect as though the act had been an act of the Engineer. However:
- a) Any failure to disapprove any work, Plant or Materials shall not constitute approval, and shall therefore not prejudice the right of the Architect to reject the work, Plant or Materials;
 - b) If the Contractor questions any determination or instruction of an assistant, the Contractor may refer the matter to the Engineer, who shall promptly confirm, reverse or vary the determination or instruction.

33 Instructions of the Engineer

- 3.3.1 The Architect may issue to the Contractor (at anytime) instructions and additional or modified Drawings which may be necessary for the execution of the Works and the remedying of any defects, all in accordance with the Contract. The Contractor shall only take instructions from the Engineer, or from an assistant to whom the appropriate authority has been delegated under Clause 3.2.1.
- 3.3.2 The Contractor shall comply with the instructions given by the Architect or delegated assistant, on any matter related to the Contract. Whenever practicable, their instructions shall be given in writing. If the Architect or a delegated assistant:
- a) Gives an oral instruction,
 - b) receives a written confirmation of the instruction, from (or on behalf of) the Contractor, within two working days after giving the instruction, and

- c) does not reply by issuing a written rejection and/or instruction within two working days after receiving the confirmation,

Then the confirmation shall constitute the written instruction of the Architect or delegated assistant (as the case may be).

34 Replacement of the Engineer

If the Procuring Entity intends to replace the Engineer, the Procuring Entity shall, in not less than 21 days before the intended date of replacement, give notice to the Contractor of the name, address and relevant experience of the intended person to replace the Engineer.

35 Determinations

3.5.1 Whenever these Conditions provide that the Architect shall proceed in accordance with this Sub-Clause 3.5 to agree or determine any matter, the Architect shall consult with each Party in an endeavor to reach agreement. If agreement is not achieved, the Architect shall make a fair determination in accordance with the Contract, taking due regard of all relevant circumstances.

3.5.1 The Architect shall give notice to both Parties of each agreement or determination, with supporting particulars, within 30 days from the receipt of the corresponding claim or request except when otherwise specified. Each Party shall give effect to each agreement or determination unless and until revised under Clause 20 [Claims, Disputes and Arbitration].

4 THE CONTRACTOR

4.1 Contractor's General Obligations

4.1.1 The Contractor shall design (to the extent specified in the Contract), execute and complete the Works in accordance with the Contract and with the Architect instructions, and shall remedy any defects in the Works.

4.1.2 The Contractor shall provide the Plant and Contractor's Documents specified in the Contract, and all Contractor's Personnel, Goods, consumables and other things and services, whether of a temporary or permanent nature, required in and for this design, execution, completion and remedying of defects.

4.1.3 All equipment, material, and services to be incorporated in or required for the Works shall have their origin in any eligible source country.

4.1.4 The Contractor shall be responsible for the adequacy, stability and safety of all Site operations and of all methods of construction. Except to the extent specified in the Contract, the Contractor (i) shall be responsible for all Contractor's Documents, Temporary Works, and such design of each item of Plant and Materials as is required for the item to be in accordance with the Contract, and (ii) shall not otherwise be responsible for the design specification of the Permanent Works.

4.1.5 The Contractor shall, whenever required by the Engineer, submit details of the arrangements and methods which the Contractor proposes to adopt for the execution of the Works. No significant alteration to these arrangements and methods shall be made without this having previously been notified to the Engineer.

4.1.6 If the Contract specifies that the Contractor shall design any part of the Permanent Works, then unless otherwise stated in the Special Conditions:

- a) The Contractor shall submit to the Architect the Contractor's Documents for this part in accordance with the procedures specified in the Contract;
- b) these Contractor's Documents shall be in accordance with the Specification and Drawings, shall be written in the language for communications defined in Sub-Clause 1.4 [Law and Language], and shall include additional information required by the Architect to add to the Drawings for co-ordination of each Party's designs;
- c) the Contractor shall be responsible for this part and it shall, when the Works are completed, be fit for such purposes for which the part is intended as are specified in the Contract; and
- d) prior to the commencement of the Tests on Completion, the Contractor shall submit to the Architect the "as-built" documents and, if applicable, operation and maintenance manuals in accordance with the

Specification and in sufficient detail for the Procuring Entity to operate, maintain, dismantle, reassemble, adjust and repair this part of the Works. Such part shall not be considered to be completed for the purposes of taking-over under Sub-Clause 10.1 [Taking Over of the Works and Sections] until these documents and manuals have been submitted to the Engineer.

42 Performance Security

- 4.21 The Contractor shall obtain (at his cost) a Performance Security for proper performance, in the amount stated in the **Special Conditions of Contract** and denominated in the currency (ies) of the Contract or in a freely convertible currency acceptable to the Procuring Entity. If an amount is not stated in the Special Conditions of Contract, this Sub-Clause shall not apply.
- 4.22 The Contractor shall deliver the Performance Security to the Procuring Entity within 30 days after receiving the Notification of Award and shall send a copy to the Engineer. The Performance Security shall be issued by a reputable bank selected by the Contractor and shall be in the form annexed to the Special Conditions, as stipulated by the Procuring Entity in the Special Conditions of Contract, or in another form approved by the Procuring Entity.
- 4.23 The Contractor shall ensure that the Performance Security is valid and enforceable until the Contractor has executed and completed the Works and remedied any defects. If the terms of the Performance Security specify its expiry date, and the Contractor has not become entitled to receive the Performance Certificate by the date 30 days prior to the expiry date, the Contractor shall extend the validity of the Performance Security until the Works have been completed and any defects have been remedied.
- 4.24 The Procuring Entity shall not make a claim under the Performance Security, except for amounts to which the Procuring Entity is entitled under the Contract.
- 4.25 The Procuring Entity shall indemnify and hold the Contractor harmless against and from all damages, losses and expenses (including legal fees and expenses) resulting from a claim under the Performance Security to the extent to which the Procuring Entity was not entitled to make the claim.
- 4.26 The Procuring Entity shall return the Performance Security to the Contractor within 14 days after receiving a copy of the Taking-Over Certificate.
- 4.27 Without limitation to the provisions of the rest of this Sub-Clause, whenever the Architect determines an addition or a reduction to the Contract Price as a result of a change in cost and/ or legislation, or as a result of a Variation, amounting to more than 25 percent of the portion of the Contract Price payable in a specific currency, the Contractor shall at the Architect request promptly increase, or may decrease, as the case may be, the value of the Performance Security in that currency by an equal percentage.

43 Contractor's Representative

- 4.31 The Contractor shall appoint the Contractor's Representative and shall give him all authority necessary to act on the Contractor's behalf under the Contract. The Contractor's Representative's Name and Address shall be provided in the **Special Conditions of Contract**.
- 4.32 Unless the Contractor's Representative **is named in the Contract**, the Contractor shall, prior to the Commencement Date, submit to the Architect for consent the name and particulars of the person the Contractor proposes to appoint as Contractor's Representative. If consent is withheld or subsequently revoked in terms of Sub-Clause 6.9 [Contractor's Personnel], or if the appointed person fails to act as Contractor's Representative, the Contractor shall similarly submit the name and particulars of an other suitable person for such appointment.
- 4.33 The Contractor shall not, without the prior consent of the Engineer, revoke the appointment of the Contractor's Representative or appoint a replacement.
- 4.34 The whole time of the Contractor's Representative shall be given to directing the Contractor's performance of the Contract. If the Contractor's Representative is to be temporarily absent from the Site during the execution of the Works, a suitable replacement person shall be appointed, subject to the Architect prior consent, and the Architect shall be notified accordingly.
- 4.35 The Contractor's Representative shall, on behalf of the Contractor, receive instructions under Sub-Clause 3.3 [Instructions of the Engineer].

4.36 The Contractor's Representative may delegate any powers, functions and authority to any competent person, and may at any time revoke the delegation. Any delegation or revocation shall not take effect until the Architect has received prior notice signed by the Contractor's Representative, naming the person and specifying the powers, functions and authority being delegated or revoked.

4.37 The Contractor's Representative shall be fluent in the language for communications defined in Sub-Clause 1.4 [Law and Language]. If the Contractor's Representative's delegates are not fluent in the said language, the Contractor shall make competent interpreter available during all working hours in a number deemed sufficient by the Engineer.

44 Sub-contractors

4.41 The Contractor shall not subcontract the whole of the Works. The contractor may however subcontract the works as provided in Clause 34.2.

4.42 The Contractor shall be responsible for the acts or defaults of any Subcontractor, his agents or employees, as if they were acts or defaults of the Contractor. Unless otherwise stated in the Special Conditions:

- a) The Contractor shall not be required to obtain consent to suppliers solely of Materials, or to a subcontract for which the Subcontractor is named in the Contract;
- b) The prior consent of the Procuring Entity shall be obtained to other proposed Subcontractors;
- c) the Contractor shall give the Procuring Entity not less than 14 days' notice of the intended date of the commencement of each Subcontractor's work, and of the commencement of such work on the Site; and
- d) each subcontract shall include provisions which would entitle the Procuring Entity to require the subcontract to be assigned to the Procuring Entity under Sub-Clause 4.5 [Assignment of Benefit of Subcontract] (if or when applicable) or in the event of termination under Sub-Clause 15.2 [Termination by Procuring Entity].

4.43 The Contractor shall ensure that the requirements imposed on the Contractor by Sub-Clause 1.12 [Confidential Details] apply equally to each Subcontractor.

4.44 Where practicable, the Contractor shall give fair and reasonable opportunity for contractors from Kenya to be appointed as Subcontractors.

45 Assignment of Benefit of Subcontract

If a Subcontractor's obligations extend beyond the expiry date of the relevant Defects Notification Period and the Engineer, prior to this date, instructs the Contractor to assign the benefit of such obligations to the Procuring Entity, then the Contractor shall do so. Unless otherwise stated in the assignment, the Contractor shall have no liability to the Procuring Entity for the work carried out by the Subcontractor after the assignment takes effect.

46 Co-operation

4.61 The Contractor shall, as specified in the Contract or as instructed by the Engineer, allow appropriate opportunities for carrying out work to:

- a) The Procuring Entity's Personnel,
- b) Any other contractors employed by the Procuring Entity, and
- c) The personnel of any legally constituted public authorities, who may be employed in the execution on or near the Site of any work not included in the Contract.

4.62 Any such instruction shall constitute a Variation if and to the extent that it causes the Contractor to suffer delays and/or incur Unforeseeable Cost. Services for these personnel and other contractors may include the use of Contractor's Equipment, Temporary Works or access arrangements which are the responsibility of the Contractor.

4.63 If, under the Contract, the Procuring Entity is required to give to the Contractor possession of any foundation, structure, plant or means of access in accordance with Contractor's Documents, the Contractor shall submit such documents to the Architect in the time and manner stated in the Specification.

47 Setting Out of the Works

- 4.7.1 The Contractor shall set out the Works in relation to original points, lines and levels of reference specified in the Contract notified by the Engineer. The Contractor shall be responsible for the correct positioning of all parts of the Works, and shall rectify any error in the positions, levels, dimensions or alignment of the Works.
- 4.7.2 The Procuring Entity shall be responsible for any errors in these specified or notified items of reference, but the Contractor shall use reasonable efforts to verify their accuracy before they are used.
- 4.7.3 If the Contractor suffers delay and/or incurs Cost from executing work which was necessitated by an error in these items of reference, and an experienced contractor could not reasonably have discovered such error and avoided this delay and/or Cost, the Contractor shall give notice to the Architect and shall be entitled subject to Sub-Clause 20.1 [Contractor's Claims] to:
- a) an extension of time for any such delay, if completion is or will be delayed, under Sub-Clause 8.4 [Extension of Time for Completion], and
 - b) payment of any such costs accrued, which shall be included in the Contract Price.
- 4.7.4 After receiving this notice, the Architect shall proceed in accordance with Sub-Clause 3.5 [Determinations] to agree or determine (i) whether and (if so) to what extent the error could not reasonably have been discovered, and (ii) the matters described in sub-paragraphs (a) and (b) above related to this.

48 Safety Procedures

The Contractor shall:

- a) Comply with all applicable safety regulations,
- b) Take care for the safety of all persons entitled to be on the Site,
- c) Use reasonable efforts to keep the Site and Works clear of unnecessary obstruction so as to avoid danger to these persons,
- d) provide fencing, lighting, guarding and watching of the Works until completion and taking over under Clause 10 [Procuring Entity's Taking Over], and
- e) provide any Temporary Works (including roadways, footways, guards and fences) which may be necessary, because of the execution of the Works, for the use and protection of the public and of owners and occupiers of adjacent land.

49 Quality Assurance

- 4.9.1 The Contractor shall institute a quality assurance system to demonstrate compliance with the requirements of the Contract. The system shall be in accordance with the details stated in the Contract. The Architect shall be entitled to audit any aspect of the system.
- 4.9.2 Details of all procedures and compliance documents shall be submitted to the Architect or information before each design and execution stage is commenced. When any document of a technical nature is issued to the Engineer, evidence of the prior approval by the Contractor itself shall be apparent on the document itself.

Compliance with the quality assurance system shall not relieve the Contractor of any of his duties, obligations or responsibilities under the Contract.

4.10 Site Data

- 4.10.1 The Procuring Entity shall have made available to the Contractor for his information, prior to the Base Date, all relevant data in the Procuring Entity's possession on sub-surface and hydrological conditions at the Site, including environmental aspects. The Procuring Entity shall similarly make available to the Contractor all such data which come into the Procuring Entity's possession after the Base Date. The Contractor shall be responsible for interpreting all such data.
- 4.10.2 To the extent which was practicable (taking account of cost and time), the Contractor shall be deemed to have obtained all necessary information as to risks, contingencies and other circumstances which may influence or affect the Tender or Works. To the same extent, the Contractor shall be deemed to have inspected and examined

the Site, its surroundings, the above data and other available information, and to have been satisfied before submitting the Tender as to all relevant matters, including (without limitation):

- a) The form and nature of the Site, including sub-surface conditions,
- b) the hydrological and climatic conditions,
- c) the extent and nature of the work and Goods necessary for the execution and completion of the Works and the remedying of any defects,
- d) the Laws, procedures and labour practices of Kenya, and
- e) the Contractor's requirements for access, accommodation, facilities, personnel, power, transport, water and other services.

4.11 Sufficiency of the Accepted Contract Amount

4.11.1 The Contractor shall be deemed to:

- a) Have satisfied itself as to the correctness and sufficiency of the Accepted Contract Amount, and
- b) have based the Accepted Contract Amount on the data, interpretations, necessary information, inspections, examinations and satisfaction as to all relevant matters referred to in Sub-Clause 4.10 [Site Data].

4.11.2 Unless otherwise stated in the Contract, the Accepted Contract Amount covers all the Contractor's obligations under the Contract (including those under Provisional Sums, if any) and all things necessary for the proper execution and completion of the Works and the remedying of any defects.

4.12 Unforeseeable Physical Conditions

4.12.1 In this Sub-Clause, "physical conditions" means natural physical conditions and man-made and other physical obstructions and pollutants, which the Contractor encounters at the Site when executing the Works, including sub-surface and hydrological conditions but excluding climatic conditions.

4.12.2 If the Contractor encounters adverse physical conditions which he considers to have been Unforeseeable, the Contractor shall give notice to the Architect as soon as practicable.

4.12.3 This notice shall describe the physical conditions, so that they can be inspected by the Architect and shall set out the reasons why the Contractor considers them to be Unforeseeable. The Contractor shall continue executing the Works, using such proper and reasonable measures as are appropriate for the physical conditions, and shall comply with any instructions which the Architect may give. If an instruction constitutes a Variation, Clause 13 [Variations and Adjustments] shall apply.

4.12.4 If and to the extent that the Contractor encounters physical conditions which are Unforeseeable, gives such a notice, and suffers delay and/or incurs Cost due to these conditions, the Contractor shall be entitled subject to notice under Sub-Clause 20.1 [Contractor's Claims] to:

- a) an extension of time for any such delay, if completion is or will be delayed, under Sub-Clause 8.4 [Extension of Time for Completion], and
- b) payment of any such Cost, which shall be included in the Contract Price.

4.12.5 Upon receiving such notice and inspecting and/or investigating these physical conditions, the Architect shall proceed in accordance with Sub-Clause 3.5 [Determinations] to agree or determine (i) whether and (if so) to what extent these physical conditions were Unforeseeable, and (ii) the matters described in sub-paragraphs (a) and (b) above related to this extent.

4.12.6 However, before additional Cost is finally agreed or determined under sub-paragraph (ii), the Architect may also review whether other physical conditions in similar parts of the Works (if any) were more favorable than could reasonably have been foreseen when the Contractor submitted the Tender. If and to the extent that these more favorable conditions were encountered, the Architect may proceed in accordance with Sub-Clause 3.5

[Determinations] to agree or determine the reductions in Cost which were due to these conditions, which may be included (as deductions) in the Contract Price and Payment Certificates. However, the net effect of all adjustments under sub-paragraph (b) and all these reductions, for all the physical conditions encountered in similar parts of the Works, shall not result in a net reduction in the Contract Price.

4.12.7 The Architect shall take account of any evidence of the physical conditions foreseen by the Contractor when submitting the Tender, which shall be made available by the Contractor, but shall not be bound by the Contractor's interpretation of any such evidence.

4.13 Rights of Way and Facilities

Unless otherwise specified in the Contract the Procuring Entity shall provide effective access to and possession of the Site including special and/or temporary rights-of-way which are necessary for the Works. The Contractor shall obtain, at his risk and cost, any additional rights of way or facilities outside the Site which he may require for the purposes of the Works.

4.14 Avoidance of Interference

4.14.1 The Contractor shall not interfere unnecessarily or improperly with:

- a) The convenience of the public, or
- b) The access to and use and occupation of all roads and foot paths, irrespective of whether they are public or in the possession of the Procuring Entity or of others.

4.14.2 The Contractor shall indemnify and hold the Procuring Entity harmless against and from all damages, losses and expenses (including legal fees and expenses) resulting from any such unnecessary or improper interference.

4.15 Access Route

4.15.1 The Contractor shall be deemed to have been satisfied as to the suitability and availability of access routes to the Site at Base Date. The Contractor shall use reasonable efforts to prevent any road or bridge from being damaged by the Contractor's traffic or by the Contractor's Personnel. These efforts shall include the proper use of appropriate vehicles and routes.

4.15.2 Except as otherwise stated in these Conditions:

- a) The Contractor shall (as between the Parties) be responsible for any maintenance which may be required for his use of access routes;
- b) the Contractor shall provide all necessary signs or directions along access routes, and shall obtain any permission which may be required from the relevant authorities for his use of routes, signs and directions;
- c) the Procuring Entity shall not be responsible for any claims which may arise from the use or otherwise of any access route;
- d) the Procuring Entity does not guarantee the suitability or availability of particular access routes; and
- e) Costs due to non-suitability or non-availability, for the use required by the Contractor, of access routes shall be borne by the Contractor.

4.16 Transport of Goods

Unless otherwise stated in the Special Conditions:

- a) the Contractor shall give the Architect not less than 21 days' notice of the date on which any Plant or a major item of other Goods will be delivered to the Site;
- b) the Contractor shall be responsible for packing, loading, transporting, receiving, unloading, storing and protecting all Goods and other things required for the Works; and
- c) the Contractor shall indemnify and hold the Procuring Entity harmless against and from all damages, losses and expenses (including legal fees and expenses) resulting from the transport of Goods and shall negotiate and pay all claims arising from their transport.

4.17 Contractor's Equipment

The Contractor shall be responsible for all Contractor's Equipment. When brought on to the Site, Contractor's Equipment shall be deemed to be exclusively intended for the execution of the Works. The Contractor shall not remove from the Site any major items of Contractor's Equipment without the consent of the Engineer. However, consent shall not be required for vehicles transporting Goods or Contractor's Personnel off Site.

4.18 Protection of the Environment

- 4.18.1 The contractor shall comply with the applicable environmental laws, regulations and policies.
- 4.18.2 The Contractor shall take all reasonable steps to protect the environment (both on and off the Site) and to limit damage and nuisance to people and property resulting from pollution, noise and other results of his operations.
- 4.18.3 The Contractors shall ensure that emissions, surfaced is charges and effluent from the Contractor's activities shall not exceed the values stated in the Specification or prescribed by applicable Laws.

4.19 Electricity, Water and Gas

- 4.19.1 The Contractor shall, except as stated below, be responsible for the provision of all power, water and other services he may require for his construction activities and to the extent defined in the Specifications, for the tests.
- 4.19.2 The Contractor shall be entitled to use for the purposes of the Works such supplies of electricity, water, gas, and other services as may be available on the Site and of which details and prices are given in the Specifications. The Contractor shall, at his risk and cost, provide any apparatus necessary for his use of these services and for measuring the quantities consumed.
- 4.19.3 The quantities consumed and the amounts due (at these prices) for such services shall be agreed or determined by the Architect in accordance with Sub-Clause 2.5 [Procuring Entity's Claims] and Sub-Clause 3.5 [Determinations]. The Contractor shall pay these amounts to the Procuring Entity.

4.20 Procuring Entity's Equipment and Free-Issue Materials

- 4.20.1 The Procuring Entity shall make the Procuring Entity's Equipment (if any) available for the use of the Contractor in the execution of the Works in accordance with the details, arrangements and prices stated in the Specification. Unless otherwise stated in the Specification:
- a) The Procuring Entity shall be responsible for the Procuring Entity's Equipment, except that
 - b) the Contractor shall be responsible for each item of Procuring Entity's Equipment whilst any of the Contractor's Personnel is operating it, driving it, directing it or in possession or control of it.
- 4.20.1 The appropriate quantities and the amounts due (at such stated prices) for the use of Procuring Entity's Equipment shall be agreed or determined by the Architect in accordance with Sub-Clause 2.5 [Procuring Entity's Claims] and Sub-Clause 3.5 [Determinations]. The Contractor shall pay these amounts to the Procuring Entity.
- 4.20.2 The Procuring Entity shall supply, free of charge, the "free-issue materials" (if any) in accordance with the details stated in the Specification. The Procuring Entity shall, at his risk and cost, provide these materials at the time and place specified in the Contract. The Contractor shall then visually inspect them and shall promptly give notice to the Architect of any shortage, defect or default in these materials. Unless otherwise agreed by both Parties, the Procuring Entity shall immediately rectify the notified shortage, defector default.
- 4.20.3 After this visual inspection, the free-issue materials shall come under the care, custody and control of the Contractor. The Contractor's obligations of inspection, care, custody and control shall not relieve the Procuring Entity of liability for any shortage, defect or default not apparent from a visual inspection.

4.21 Progress Reports

- 4.21.1 Unless otherwise stated in the Special Conditions, monthly progress reports shall be prepared by the Contractor and submitted to the Architect in six copies. The first report shall cover the period up to the end of the first calendar month following the Commencement Date. Reports shall be submitted monthly thereafter, each within 7 days after the last day of the period to which it relates.
- 4.21.2 Reporting shall continue until the Contractor has completed all work which is known to be outstanding at the completion date stated in the Taking-Over Certificate for the Works. Each report shall include:
- a) charts and detailed descriptions of progress, including each stage of design (if any), Contractor's Documents, procurement, manufacture, delivery to Site, construction, erection and testing; and including these stages for work by each nominated Subcontractor (as defined in Clause 5 [NominatedSubcontractors]),
 - b) photographs showing the status of manufacture and of progress on the Site;
 - c) for the manufacture of each main item of Plant and Materials, the name of the manufacturer, manufacture location, percentage progress, and the actual or expected dates of:
 - i) commencement of manufacture,
 - ii) Contractor's inspections,
 - iii) tests, and
 - iv) shipment and arrival at the Site;
 - d) the details described in Sub-Clause 6.10 [Records of Contractor's Personnel and Equipment];
 - e) copies of quality assurance documents, test results and certificates of Materials;
 - f) list of notices given under Sub-Clause 2.5 [Procuring Entity's Claims] and notices given under Sub- Clause 20.1 [Contractor's Claims];
 - g) safety statistics, including details of any hazardous incidents and activities relating to environmental aspects and public relations; and
 - h) comparison so factual and planned progress, with details of any events or circumstances which may jeopardize the completion in accordance with the Contract, and the measures being (or to be) adopted to overcome delays.

4.22 Security of the Site

Unless otherwise stated in the Special Conditions:

- a) The Contractor shall be responsible for keeping unauthorized persons off the Site, and
- b) authorized persons shall be limited to the Contractor's Personnel and the Procuring Entity's Personnel; and to any other personnel notified to the Contractor, by the Procuring Entity or the Engineer, as authorized personnel of the Procuring Entity's other contractors on the Site.

4.23 Contractor's Operations on Site

- 4.23.1 The Contractor shall confine his operations to the Site, and to any additional areas which may be obtained by the Contractor and agreed by the Architect as additional working areas. The Contractor shall take all necessary precautions to keep Contractor's Equipment and Contractor's Personnel within the Site and these additional areas, and to keep them off adjacentl and.
- 4.23.2 During the execution of the Works, the Contractor shall keep the Site free from all unnecessary obstruction and shall store or dispose of any Contractor's Equipment or surplus materials. The Contractor shall clear away and remove from the Site any wreckage, rubbish and Temporary Works which are no longer required.
- 4.23.3 Upon the issue of a Taking-Over Certificate, the Contractor shall clear away and remove, from that part of the Site and Works to which the Taking-Over Certificate refers, all Contractor's Equipment, surplus material, wreckage, rubbish and Temporary Works. The Contractor shall leave that part of the Site and the Works in a clean and safe condition. However, the Contractor may retain on Site, during the Defects Notification Period, such Goods as are required for the Contractor to fulfil obligations under the Contract.

4.24 Fossils

- 4.24.1 All fossils, coins, articles of value or antiquity, and structures and other remains or items of geological or archaeological interest found on the Site shall be placed under the care and authority of the Procuring Entity. The Contractor shall take reasonable precautions to prevent Contractor's Personnel or other persons from removing or damaging any of these findings.
- 4.24.2 The Contractor shall, upon discovery of any such finding, promptly give notice to the Engineer, who shall issue instructions for dealing with it. If the Contractor suffers delay and/or incurs Cost from complying with the instructions, the Contractor shall give a further notice to the Architect and shall be entitled subject to Sub-Clause 20.1 [Contractor's Claims] to:
- a) an extension of time for any such delay, if completion is or will be delayed, under Sub-Clause 8.4 [Extension of Time for Completion], and
 - b) payment of any such Cost, which shall be included in the Contract Price.
- After receiving this further notice, the Architect shall proceed in accordance with Sub-Clause 3.5 [Determinations] to agree or determine these matters.

5 NOMINATED SUBCONTRACTORS

5.1 Definition of "nominated Sub contractor."

In this Contract, "nominated Subcontractor" means a Subcontractor:

- a) Who is nominated by the Procuring Entity, or
- b) Contractor has nominated as a Subcontractor subject to Sub-Clause 5.2 [Objection to Notification].

5.2 Objection to Nomination

The Contractor shall not be under any obligation to employ a nominated Subcontractor against whom the Contractor raises reasonable objection by notice to the Procuring Entity as soon as practicable, with supporting particulars. An objection shall be deemed reasonable if it arises from (among other things) any of the following matters, unless the Procuring Entity agrees in writing to indemnify the Contractor against and from the consequences of the matter:

- a) there are reasons to believe that the Subcontractor does not have sufficient competence, resources or financial strength;
- b) the nominated Subcontractor does not accept to indemnify the Contractor against and from any negligence or misuse of Goods by the nominated Subcontractor, his agents and employees; or
- c) the nominated Subcontractor does not accept to enter into a subcontract which specifies that, for the subcontracted work (including design, if any), the nominated Subcontractor shall:
 - i) undertake to the Contractor such obligations and liabilities as will enable the Contractor to discharge his obligations and liabilities under the Contract;
 - ii) indemnify the Contractor against and from all obligations and liabilities arising under or in connection with the Contract and from the consequences of any failure by the Subcontractor to perform these obligations or to fulfil these liabilities, and
 - iii) be paid only if and when the Contractor has received from the Procuring Entity payments for sums due under the Subcontract referred to under Sub-Clause 5.3 [Payment to nominated Subcontractors].

5.3 Payments to nominated Subcontractors

The Contractor shall pay to the nominated Subcontractor the amounts shown on the nominated Subcontractor's invoices approved by the Contractor which the Architect certifies to be due in accordance with the subcontract. These amounts plus other charges shall be included in the Contract Price in accordance with sub-paragraph (b) of Sub-Clause 13.5 [Provisional Sums], except as stated in Sub-Clause 5.4 [Evidence of Payments].

5.4 Evidence of Payments

- 5.4.1 Before issuing a Payment Certificate which includes an amount payable to a nominated Subcontractor, the Architect may request the Contractor to supply reasonable evidence that the nominated Subcontractor has received all amounts due in accordance with previous Payment Certificates, less applicable deductions for retention or otherwise. Unless the Contractor:

- (a) Submits this reasonable evidence to the Engineer, or
- (b)
 - i) Satisfies the Architect in writing that the Contractor is reasonably entitled to withhold or refuse to pay these amounts, and
 - ii) Submits to the Architect reasonable evidence that the nominated Subcontractor has been notified of the Contractor's entitlement, then the Procuring Entity may (at his sole discretion) pay, directly to the nominated Subcontractor, part or all of such amounts previously certified (less applicable deductions) as are due to the nominated Subcontractor and for which the Contractor has failed to submit the evidence described in sub-paragraphs (a) or (b) above. The Contractor shall then repay, to the Procuring Entity, the amount which the nominated Subcontractor was directly paid by the Procuring Entity.

6 STAFF AND LABOR

6.1 Engagement of Staff and Labor

Except as otherwise stated in the Specification, the Contractor shall make arrangements for the engagement of all staff and labor, local or otherwise, and for their payment, feeding, transport, and, when appropriate, housing. The Contractor is encouraged, to the extent practicable and reasonable, to employ staff and labor with appropriate qualifications and experience from sources within Kenya.

6.2 Rates of Wages and Conditions of Labor

6.2.1 The Contractor shall pay rates of wages, and observe conditions of labor, which are not lower than those established for the trade or industry where the work is carried out. If no established rates or conditions are applicable, the Contractor shall pay rates of wages and observe conditions which are not lower than the general level of wages and conditions observed locally by Procuring Entity's whose trade or industry is similar to that of the Contractor.

6.2.2 The Contractor shall inform the Contractor's Personnel about their liability to pay personal income taxes in Kenya in respect of such of their salaries, wages, allowances and any benefits as are subject to tax under the Laws of Kenya for the time being in force, and the Contractor shall perform such duties in regard to such deductions there of as may be imposed on him by such Laws.

6.3 Persons in the Service of Procuring Entity

The Contractor shall not recruit, or attempt to recruit, staff and labour from amongst the Procuring Entity's Personnel.

6.4 Labor Laws

The Contractor shall comply with all the relevant labour Laws applicable to the Contractor's Personnel, including Laws relating to their employment, employment of children, health, safety, welfare, immigration and emigration, and shall allow them all their legal rights. The Contractor shall require his employees to obey all applicable Laws, including those concerning safety at work.

6.5 Working Hours

No work shall be carried out on the Site on locally recognized days of rest, or outside the normal working hours stated in the **Special Conditions of Contract**, unless:

- a) Otherwise stated in the Contract,
- b) The Architect gives consent, or
- c) The work is unavoidable, or necessary for the protection of life or property or for the safety of the Works, in which case the Contractor shall immediately advise the Engineer, provided that work done outside the normal working hours shall be considered and paid for as overtime.

6.6 Facilities for Staff and Labor

Except as otherwise stated in the Specification, the Contractor shall provide and maintain all necessary accommodation and welfare facilities on site for the Contractor's Personnel. The Contractor shall also provide facilities for the Procuring Entity's Personnel as stated in the Specifications. The Contractor shall not permit any of the Contractor's Personnel to maintain any temporary or permanent living quarters within the structures forming part of the Permanent Works.

67 Health and Safety

- 67.1 The Contractor shall at all times take all reasonable precautions to maintain the health and safety of the Contractor's Personnel. In collaboration with local health authorities, the Contractor shall ensure that medical staff, first aid facilities, sick bay and ambulance service are available at all times at the Site and at any accommodation for Contractor's and Procuring Entity's Personnel, and that suitable arrangements are made for all necessary welfare and hygiene requirements and for the prevention of epidemics.
- 67.2 The Contractor shall appoint an accident prevention officer at the Site, responsible for maintaining safety and protection against accidents. This person shall be qualified for this responsibility and shall have the authority to issue instructions and take protective measures to prevent accidents. Throughout the execution of the Works, the Contractor shall provide what ever is required by this person to exercise this responsibility and authority.
- 67.3 The Contractor shall send, to the Engineer, details of any accident as soon as practicable after its occurrence. The Contractor shall maintain records and make reports concerning health, safety and welfare of persons, and damage to property, as the Architect may reasonably require.
- 67.4 The Contractor shall conduct an awareness programme on HIV and other sexually transmitted diseases via an approved service provider and shall undertake such other measures taken to reduce the risk of the transfer of these diseases between and among the Contractor's Personnel and the local community, to promote early diagnosis and to assist affected individuals.

68 Contractor's Superintendence

- 68.1 Throughout the execution of the Works, and as long thereafter as is necessary to fulfil the Contractor's obligations, the Contractor shall provide all necessary superintendence to plan, arrange, direct, manage, inspect and test the work.
- 68.2 Superintendence shall be given by a sufficient number of persons having adequate knowledge of the language for communications (defined in Sub-Clause 1.4 [Law and Language]) and of the operations to be carried out (including the methods and techniques required, the hazards likely to be encountered and methods of preventing accidents), for the satisfactory and safe execution of the Works.

69 Contractor's Personnel

- 69.1 The Contractor's Personnel shall be appropriately qualified, skilled and experienced in their respective trades or occupations. The Contractor's Key personnel shall be named in the Special Conditions of Contract. The Architect may require the Contractor to remove (or cause to be removed) any person employed on the Site or Works, including the Contractor's Representative if applicable, who:
- a) Persists in any misconduct or lack of care,
 - b) Carries out duties in competently or negligently,
 - c) fails to conform with any provisions of the Contract,
 - d) persists in any conduct which is prejudicial to safety, health, or the protection of the environment, or
 - e) based on reasonable evidence, is determined to have engaged in Fraud and Corruption during the execution of the Works.
- 69.2 If appropriate, the Contractor shall then appoint (or cause to be appointed) a suitable replacement person.

610 Records of Contractor's Personnel and Equipment

The Contractor shall submit, to the Engineer, details showing the number of each class of Contractor's Personnel and of each type of Contractor's Equipment on the Site. Details shall be submitted each calendar month, in a form approved by the Engineer, until the Contractor has completed all work which is known to be outstanding at the completion date stated in the Taking-Over Certificate for the Works.

611 Disorderly Conduct

The Contractor shall at all times take all reasonable precautions to prevent any unlawful, riotous or disorderly conduct by or amongst the Contractor's Personnel, and to preserve peace and protection of persons and property on and near the Site.

6.12 Foreign Personnel

- 6.12.1 The Contractor shall not employ foreign personnel unless the contractor demonstrates that there are no Kenyans with the required skills.
- 6.12.2 The Contractor shall be responsible for the return of any foreign personnel to the place where they were recruited or to their domicile. In the event of the death in Kenya of any of these personnel or members of their families, the Contractor shall similarly be responsible for making the appropriate arrangements for their return or burial.

6.13 Supply of Water

The Contractor shall, having regard to local conditions, provide on the Site an adequate supply of drinking and other water for the use of the Contractor's Personnel.

6.14 Measures against Insect and Pest Nuisance

The Contractor shall at all times take the necessary precautions to protect the Contractor's Personnel employed on the Site from insect and pest nuisance, and to reduce the danger to their health. The Contractor shall comply with all the regulations of the local health authorities, including use of appropriate insecticide.

6.15 Alcoholic Liquor or Drugs

The Contractor shall not, otherwise than in accordance with the Laws of Kenya, onsite, import, sell, give, barter or otherwise dispose of any alcoholic liquor or drugs, or permit or allow importation, sale, gift, barter or disposal thereof by Contractor's Personnel.

6.16 Prohibition of Forced or Compulsory Labour

The Contractor shall not employ forced labor, which consists of any work or service, not voluntarily performed, that is exacted from an individual under threat of force or penalty, and includes any kind of involuntary or compulsory labor, such as indentured labor, bonded labor or similar labor-contracting arrangements.

6.17 Prohibition of Harmful Child Labor

The Contractor shall not employ children in a manner that is economically exploitative, or is likely to be hazardous, or to interfere with, the child's education, or to be harmful to the child's health or physical, mental, spiritual, moral, or social development. Where the relevant labour laws of Kenya have provisions for employment of minors, the Contractor shall follow those laws applicable to the Contractor. Children below the age of 18 years shall not be employed in dangerous work.

6.18 Employment Records of Workers

The Contractor shall keep complete and accurate records of the employment of labour at the Site. The records shall include the names, ages, genders, hours worked and wages paid to all workers. These records shall be summarized on a monthly basis and submitted to the Engineer. These records shall be included in the details to be submitted by the Contractor under Sub-Clause 6.10 [Records of Contractor's Personnel and Equipment].

6.19 Workers' Organizations

The Contractor shall comply with the relevant labor laws that recognize workers' rights to form and to join workers' organizations of their choosing without interference.

6.20 Non-Discrimination and Equal Opportunity

The Contractor shall base the labour employment on the principle of equal opportunity and fair treatment and shall not discriminate with respect to aspects of the employment relationship, including recruitment and hiring, compensation (including wages and benefits), working conditions and terms of employment, access to training, promotion, termination of employment, retirement, and discipline.

7. PLANT, MATERIALS AND WORKMANSHIP

7.1 Manner of Execution

The Contractor shall carry out the manufacture/assemble of plant, the production and manufacture of Materials, and all other execution of the Works:

- a) In the manner (if any) specified in the Contract,
- b) in a proper workman like and careful manner, in accordance with recognized good practice, and
- c) with properly equipped facilities and non-hazardous Materials, except as otherwise specified in the Contract.

7.2 Samples

The Contractor shall submit the following samples of Materials, and relevant information, to the Architect for consent prior to using the Material sin or for the Works:

- a) manufacturer's standard samples of Materials and samples specified in the Contract, all at the Contractor's cost, and
- b) additional samples instructed by the Architect as a Variation.

Each sample shall be labeled as to origin and intended use in the Works.

7.3 Inspection

7.3.1 The Procuring Entity's Personnel shall at all reasonable times:

- a) Have full access to all parts of the Site and to all places from which natural Materials are being obtained, and
- b) during production, manufacture and construction (at the Site and elsewhere), be entitled to examine, inspect, measure and test the materials and workmanship, and to check the progress of manufacture of Plant and production and manufacture of Materials.

7.3.2 The Contractor shall give the Procuring Entity's Personnel full opportunity to carry out these activities, including providing access, facilities, permissions and safety equipment. No such activity shall relieve the Contractor from any obligation or responsibility.

7.3.3 The Contractor shall give notice to the Architect whenever any work is ready and before it is covered up, put out of sight, or packaged for storage or transport. The Architect shall then either carry out the examination, inspection, measurement or testing without unreasonable delay, or promptly give notice to the Contractor that the Architect does not require to do so. If the Contractor fails to give the notice, he shall, if and when required by the Engineer, uncover the work and there after reinstate and make good, all at the Contractor's cost.

7.4 Testing

7.4.1 This Sub-Clause shall apply to all tests specified in the Contract.

7.4.2 Except as otherwise specified in the Contract, the Contractor shall provide all apparatus, assistance, documents and other information, electricity, equipment, fuel, consumables, instruments, labor, materials, and suitably qualified and experienced staff, as are necessary to carry out the specified tests efficiently. The Contractor shall agree, with the Engineer, the time and place for testing of any Plant, Materials and other parts of the Works.

7.4.3 The Architect may, under Clause 13 [Variations and Adjustments], vary the location or details of specified tests, or instruct the Contractor to carry out additional tests. If these varied or additional tests show that the tested Plant, Materials or workmanship is not in accordance with the Contract, the cost of carrying out this Variation shall be borne by the Contractor, notwithstanding other provisions of the Contract.

7.4.4 The Architect shall give the Contractor not less than 24 hours' notice of the Architect intention to attend the tests. If the Architect does not attend at the time and place agreed, the Contractor may proceed with the tests, unless otherwise instructed by the Engineer, and the tests shall then be deemed to have been made in the Architect presence.

- 7.45 If the Contractor suffers delay and/ or incurs Cost from complying with these instructions or as a result of a delay for which the Procuring Entity is responsible, the Contractor shall give notice to the Architect and shall be entitled subject to Sub-Clause 20.1 [Contractor's Claims] to:
- a) an extension of time for any such delay, if completion is or will be delayed, under Sub-Clause 8.4 [Extension of Time for Completion], and
 - b) payment of any such Cost-plus profit, which shall be included in the Contract Price.

7.46 After receiving this notice, the Architect shall proceed in accordance with Sub-Clause 3.5 [Determinations] to agree or determine these matters.

7.47 The Contractor shall promptly forward to the Architect duly certified reports of the tests. When the specified tests have been passed, the Architect shall endorse the Contractor's test certificate, or issue a certificate to him, to that effect. If the Architect has not attended the tests, he shall be deemed to have accepted the readings as accurate.

7.5 Rejection

7.51 If, as a result of an examination, inspection, measurement or testing, any Plant, Materials or workmanship is found to be defective or otherwise not in accordance with the Contract, the Architect may reject the Plant, Materials or workmanship by giving notice to the Contractor, with reasons. The Contractor shall then promptly make good the defect and ensure that the rejected item complies with the Contract.

7.52 If the Architect requires this Plant, Materials or workmanship to be retested, the tests shall be repeated under the same terms and conditions. If the rejection and retesting cause the Procuring Entity to incur additional costs, the Contractor shall subject to Sub-Clause 2.5 [Procuring Entity's Claims] pay these costs to the Procuring Entity.

7.6 Remedial Work

7.61 Notwithstanding any previous test or certification, the Architect may instruct the Contractor to:

- a) Remove from the Site and replace any Plant or Materials which is not in accordance with the Contract,
- b) remove and re-execute any other work which is not in accordance with the Contract, and
- c) execute any work which is urgently required for the safety of the Works, whether because of an accident, unforeseen event or otherwise.

7.62 The Contractor shall comply with the instruction within a reasonable time, which shall be the time (if any) specified in the instruction, or immediately if urgency is specified under sub-paragraph (c).

7.63 If the Contractor fails to comply with the instruction, the Procuring Entity shall be entitled to employ and pay other persons to carry out the work. Except to the extent that the Contractor would have been entitled to payment for the work, the Contractor shall subject to Sub-Clause 2.5 [Procuring Entity's Claims] pay to the Procuring Entity all costs arising from this failure.

7.64 If the contractor repeatedly delivers defective work, the Procuring Entity may consider termination in accordance with Clause 15.

7.7 Ownership of Plant and Materials

Except as otherwise provided in the Contract, each item of Plant and Materials shall become the property of the Procuring Entity at whichever is the earlier of the following times, free from liens and other encumbrances:

- a) When it is incorporated in the Works;
- b) when the Contractor is paid the corresponding value of the Plant and Materials under Sub-Clause 8.10 [Payment for Plant and Materials in Event of Suspension].

7.8 Royalties

Unless otherwise stated in the Specification, the Contractor shall pay all royalties, rents and other payments for:

- a) Natural materials obtained from outside the Site, and
- b) the disposal of material from demolitions and excavations and of other surplus material (whether natural or man-made), except to the extent that disposal are as within the Site are specified in the Contract.

8 COMMENCEMENT, DELAYS AND SUSPENSION

8.1 Commencement of Works

8.1.1 Except as otherwise specified in the Special Conditions of Contract, the Commencement Date shall be the date at which the following precedent condition shall have all been fulfilled and the Architect notification recording the agreement of both Parties on such fulfilment and instructing to commence the Work is received by the Contractor:

- a) Signature of the Contract Agreement by both Parties, and if required, approval of the Contract by relevant authorities of Kenya;
- b) except if otherwise specified in the Special Conditions of Contract, effective access to and possession of the Site given to the Contractor together with such permission(s) under (a) of Sub-Clause 1.13 [Compliance with Laws] as required for the commencement of the Works.
- c) Receipt by the Contractor of the Advance Payment under Sub-Clause 14.2 [Advance Payment] provided that the corresponding bank guarantee has been delivered by the Contractor.

8.1.2 If the said Architect instruction is not received by the Contractor within 180 days from his receipt of the Letter of Acceptance, the Contractor shall be entitled to terminate the Contract under Sub-Clause 6.2 [Termination by Contractor].

8.1.3 The Contractor shall commence the execution of the Works as soon as is reasonably practicable after the Commencement Date and shall then proceed with the Works with due expedition and without delay.

8.2 Time for Completion

The Contractor shall complete the whole of the Works, and each Section (if any), within the Time for Completion for the Works or Section (as the case may be), including:

- a) Achieving the passing of the Test on Completion, and
- b) completing all work which is stated in the Contract as being required for the Works or Section to be considered to be completed for the purposes of taking-over under Sub-Clause 10.1 [Taking Over of the Works and Sections].

8.3 Programme

8.3.1 The Contractor shall submit a detailed time programme to the Architect within 14 days after receiving the notice under Sub-Clause 8.1 [Commencement of Works]. The Contractor shall also submit a revised programme whenever the previous programme is inconsistent with actual progress or with the Contractor's obligations. Each programme shall include:

- a) The order in which the Contractor intends to carry out the Works, including the anticipated timing of each stage of design (if any), Contractor's Documents, procurement, manufacture of Plant, delivery to Site, construction, erection and testing,
- b) each of these stages for work by each nominated Subcontractor (as defined in Clause 5 [Nominated Subcontractors]),
- c) the sequence and timing of inspections and tests specified in the Contract, and
- d) a supporting report which includes:
 - i) a general description of the methods which the Contractor intends to adopt, and of the major stages, in the execution of the Works, and
 - ii) details showing the Contractor's reasonable estimate of the number of each class of Contractor's Personnel and of each type of Contractor's Equipment, required on the Site for each major stage.

8.3.2 Unless the Engineer, within 14 days after receiving a programme, gives notice to the Contractor stating the extent to which it does not comply with the Contract, the Contractor shall proceed in accordance with the programme, subject to his other obligations under the Contract. The Procuring Entity's Personnel shall be entitled to rely upon the programme when planning their activities.

8.3.3 The Contractor shall promptly give notice to the Architect of specific probable future events or circumstances which may adversely affect the work, increase the Contract Price or delay the execution of the Works.

834 If, at anytime, the Architect gives notice to the Contractor that a programme fails (to the extent stated) to comply with the Contractor to be consistent with actual progress and the Contractor's stated intentions, the Contractor shall submit a revised programme to the Architect in accordance with this Sub-Clause.

8.4 Extension of Time for Completion

841 The Contractor shall be entitled subject to Sub-Clause 20.1 [Contractor's Claims] to an extension of the Time for Completion if and to the extent that completion for the purposes of Sub-Clause 10.1 [Taking Over of the Works and Sections] is or will be delayed by any of the following causes:

- a) a Variation (unless an adjustment to the Time for Completion has been agreed under Sub-Clause 13.3 [Variation Procedure]) or other substantial change in the quantity of an item of work included in the Contract,
- b) a cause of delay giving an entitlement to extension of time under a Sub-Clause of these Conditions,
- c) exceptionally adverse climatic conditions,
- d) Unforeseeable shortages in the availability of personnel or Goods caused by epidemic or governmental actions, or
- e) any delay, impediment or prevention caused by or attributable to the Procuring Entity, the Procuring Entity's Personnel, or the Procuring Entity's other contractors.

842 If the Contractor considers itself to be entitled to an extension of the Time for Completion, the Contractor shall give notice to the Architect in accordance with Sub-Clause 20.1 [Contractor's Claims]. When determining each extension of time under Sub-Clause 20.1, the Architect shall review previous determinations and may increase, but shall not decrease, the total extension of time.

8.5 Delays Caused by Authorities

If the following conditions apply, namely:

- a) The Contractor has diligently followed the procedures laid down by the relevant legally constituted public authorities in Kenya,
- b) These authorities delay or disrupt the Contractor's work, and
- c) the delay or disruption was Unforeseeable, then this delay or disruption will be considered as a cause of delay under sub-paragraph (b) of Sub-Clause 8.4 [Extension of Time for Completion].

8.6 Rate of Progress

861 If, at anytime:

- a) Actual progress is too slow to complete within the Time for Completion, and/or
- b) Progress has fallen (or will fall) behind the current programme under Sub-Clause 8.3 [Programme], other than as a result of a cause listed in Sub-Clause 8.4 [Extension of Time for Completion], then the Architect may instruct the Contractor to submit, under Sub-Clause 8.3 [Programme], a revised programme and supporting report describing the revised methods which the Contractor proposes to adopt in order to expedite progress and complete within the Time for Completion.

862 Unless the Architect notifies otherwise, the Contractor shall adopt these revised methods, which may require increases in the working hours and/or in the numbers of Contractor's Personnel and/or Goods, at the risk and cost of the Contractor. If these revised methods cause the Procuring Entity to incur additional costs, the Contractor shall subject to notice under Sub-Clause 2.5 [Procuring Entity's Claims] pay these costs to the Procuring Entity, in addition to delay damages (if any) under Sub-Clause 8.7 below.

863 Additional costs of revised methods including acceleration measures, instructed by the Architect to reduce delays resulting from causes listed under Sub-Clause 8.4 [Extension of Time for Completion] shall be paid by the Procuring Entity, without generating, however, any other additional payment benefit to the Contractor.

8.7 Delay Damages

871 If the Contractor fails to comply with Sub-Clause 8.2 [Time for Completion], the Contractor shall subject to notice under Sub-Clause 2.5 [Procuring Entity's Claims] pay delay damages to the Procuring Entity for this default. These delay damages shall be the sum stated in the **Special Conditions of Contract**, which shall be paid for everyday which shall elapse between the relevant Time for Completion and the date stated in the

Taking-Over Certificate. However, the total amount due under this Sub-Clause shall not exceed the maximum amount of delay damages (if any) stated in the Special Conditions of Contract.

8.7.2 These delay damages shall be the only damages due from the Contractor for such default, other than in the event of termination under Sub-Clause 15.2 [Termination by Procuring Entity] prior to completion of the Works. These damages shall not relieve the Contractor from his obligation to complete the Works, or from any other duties, obligations or responsibilities which he may have under the Contract.

8.8 Suspension of Work

8.8.1 The Architect may at anytime instruct the Contractor to suspend progress of part or all of the Works. During such suspension, the Contractor shall protect, store and secure such part or the Works against any deterioration, loss or damage.

8.8.2 The Architect may also notify the cause for the suspension. If and to the extent that the cause is notified and is the responsibility of the Contractor, the following Sub-Clauses 8.9, 8.10 and 8.11 shall not apply.

8.9 Consequences of Suspension

8.9.1 If the Contractor suffers delay and/or incurs Cost from complying with the Architect instructions under Sub-Clause 8.8 [Suspension of Work] and/or from resuming the work, the Contractor shall give notice to the Architect and shall be entitled subject to Sub-Clause 20.1 [Contractor's Claims] to:

- a) an extension of time for any such delay, if completion is or will be delayed, under Sub-Clause 8.4 [Extension of Time for Completion], and
- b) Payment of any such Cost, which shall be included in the Contract Price.

8.9.2 After receiving this notice, the Architect shall proceed in accordance with Sub-Clause 3.5 [Determinations] to agree or determine these matters.

8.9.3 The Contractor shall not be entitled to an extension of time for, or to payment of the Cost incurred in, making good the consequences of the Contractor's faulty design, workmanship or materials, or of the Contractor's failure to protect, store or secure in accordance with Sub-Clause 8.8 [Suspension of Work].

8.10 Payment for Plant and Materials in Event of Suspension

The Contractor shall be entitled to payment of the value (as at the date of suspension) of Plant and/ or Materials which have not been delivered to Site, if:

- a) The work on Plant or delivery of Plant and/ or Materials has been suspended for more than 30 days, and
- b) the Contractor has marked the Plant and/or Materials as the Procuring Entity's property in accordance with the Architect instructions.

8.11 Prolonged Suspension

If the suspension under Sub-Clause 8.8 [Suspension of Work] has continued for more than 84 days, the Contractor may request the Architect permission to proceed. If the Architect does not give permission within 30 days after being requested to do so, the Contractor may, by giving notice to the Engineer, treat the suspension as an omission under Clause 13 [Variations and Adjustments] of the affected part of the Works. If the suspension affects the whole of the Works, the Contractor may give notice of termination under Sub-Clause 16.2 [Termination by Contractor].

8.12 Resumption of Work

After the permission or instruction to proceed is given, the Contractor and the Architect shall jointly examine the Works and the Plant and Materials affected by the suspension. The Contractor shall make good any deterioration or defect in or loss of the Works or Plant or Materials, which has occurred during the suspension after receiving from the Architect an instruction to this effect under Clause 13 [Variations and Adjustments].

9 TESTS ON COMPLETION

9.1 Contractor's Obligations

- 9.1.1 The Contractor shall carry out the Tests on Completion in accordance with this Clause and Sub-Clause 7.4 [Testing], after providing the documents in accordance with sub-paragraph (d) of Sub-Clause 4.1 [Contractor's General Obligations].
- 9.1.2 The Contractor shall give to the Architect not less than 21 days' notice of the date after which the Contractor will be ready to carry out each of the Tests on Completion. Unless otherwise agreed, Tests on Completion shall be carried out within 14 days after this date, on such day or days as the Architect shall instruct.
- 9.1.3 In considering the results of the Tests on Completion, the Architect shall make allowances for the effect of any use of the Works by the Procuring Entity on the performance or other characteristics of the Works. As soon as the Works, or a Section, have passed any Tests on Completion, the Contractor shall submit a certified report of the results of these Tests to the Engineer.

9.2 Delayed Tests

- 9.2.1 If the Tests on Completion are being unduly delayed by the Procuring Entity, Sub-Clause 7.4 [Testing] (fifth paragraph) and/ or Sub-Clause 10.3 [Interference with Tests on Completion] shall be applicable.
- 9.2.2 If the Tests on Completion are being unduly delayed by the Contractor, the Architect may by notice require the Contractor to carry out the Tests within 21 days after receiving the notice. The Contractor shall carry out the Tests on such day or days within that period as the Contractor may fix and of which he shall give notice to the Engineer.
- 9.2.3 If the Contractor fails to carry out the Tests on Completion within the period of 21 days, the Procuring Entity's Personnel may proceed with the Tests at the risk and cost of the Contractor. The Tests on Completion shall then be deemed to have been carried out in the presence of the Contractor and the results of the Tests shall be accepted as accurate.

9.3 Retesting of related works

If the Works, or a Section, fail to pass the Tests on Completion, Sub-Clause 7.5 [Rejection] shall apply, and the Architect or the Contractor may require the failed Tests, and Tests on Completion on any related work, to be repeated under the same terms and conditions.

9.4 Failure to Pass Tests on Completion

- 9.4.1 If the Works, or a Section, fail to pass the Tests on Completion repeated under Sub-Clause 9.3 [Retesting], the Architect shall be entitled to:
- Order further repetition of Tests on Completion under Sub-Clause 9.3; or
 - if the failure deprives the Procuring Entity of substantially the whole benefit of the Works or Section, reject the Works or Section (as the case may be), in which event the Procuring Entity shall have the same remedies as are provided in sub-paragraph (c) of Sub-Clause 1.4 [Failure to Remedy Defects].

10 PROCURING ENTITY'S TAKING OVER

10.1 Taking Over of the Works and Sections

- 10.1.1 Except as stated in Sub-Clause 9.4 [Failure to Pass Tests on Completion], the Works shall be taken over by the Procuring Entity when (i) the Works have been completed in accordance with the Contract, including the matters described in Sub-Clause 8.2 [Time for Completion] and except as allowed in sub-paragraph (a) below, and (ii) a Taking-Over Certificate for the Works has been issued, or is deemed to have been issued in accordance with this Sub-Clause.
- 10.1.2 The Contractor may apply by notice to the Architect for a Taking-Over Certificate not earlier than 14 days before the Works will, in the Contractor's opinion, be complete and ready for taking over. If the Works are divided into Sections, the Contractor may similarly apply for a Taking-Over Certificate for each Section.

- 10.13 The Architect shall, within 30 days after receiving the Contractor's application:
- a) Issue the Taking-Over Certificate to the Contractor, stating the date on which the Works or Section were completed in accordance with the Contract, except for any minor outstanding work and defects which will not substantially affect the use of the Works or Section for their intended purpose (either until or whilst this work is completed and these defects are remedied); or
 - b) reject the application, giving reasons and specifying the work required to be done by the Contractor to enable the Taking-Over Certificate to be issued. The Contractor shall then complete this work before issuing a further notice under his Sub-Clause.
- 10.14 If the Architect fails either to issue the Taking-Over Certificate or to reject the Contractor's application within the period of 30 days, and if the Works or Section (as the case may be) are substantially in accordance with the Contract, the Taking-Over Certificate shall be deemed to have been issued on the last day of that period.

10.2 Taking Over of Parts of the Works

- 10.21 The Architect may, at the sole discretion of the Procuring Entity, issue a Taking-Over Certificate for any part of the Permanent Works.
- 10.22 The Procuring Entity shall not use any part of the Works (other than as a temporary measure which is either specified in the Contract or agreed by both Parties) unless and until the Architect has issued a Taking-Over Certificate for this part. However, if the Procuring Entity does use any part of the Works before the Taking-Over Certificate is issued:
- a) The part which is used shall be deemed to have been taken over as from the date on which it is used,
 - b) the Contractor shall cease to be liable for the care of such part as from this date, when responsibility shall pass to the Procuring Entity, and
 - c) if requested by the Contractor, the Architect shall issue a Taking-Over Certificate for this part.
- 10.23 After the Architect has issued a Taking-Over Certificate for a part of the Works, the Contractor shall be given the earliest opportunity to take such steps as may be necessary to carry out any outstanding Tests on Completion. The Contractor shall carry out these Tests on Completion as soon as practicable before the expiry date of the relevant Defects Notification Period.
- 10.24 If the Contractor incurs Cost as a result of the Procuring Entity taking over and/or using a part of the Works, other than such use as is specified in the Contract agreed by the Contractor, the Contractor shall (i) give notice to the Architect and (ii) be entitled subject to Sub-Clause 20.1 [Contractor's Claims] to payment of any such accrued costs, which shall be included in the Contract Price. After receiving this notice, the Architect shall proceed in accordance with Sub-Clause 3.5 [Determinations] to agree or determine this accrued cost.
- 10.25 If a Taking-Over Certificate has been issued for a part of the Works (other than a Section), the delay damages there after for completion of the remainder of the Works shall be reduced. Similarly, the delay damages for the remainder of the Section (if any) in which this part is included shall also be reduced. For any period of delay after the date stated in this Taking-Over Certificate, the proportional reduction in these delay damages shall be calculated as the proportion which the value of the part so certified bears to the value of the Works or Section (as the case may be) as a whole. The Architect shall proceed in accordance with Sub-Clause 3.5 [Determinations] to agree or determine these proportions. The provisions of this paragraph shall only apply to the daily rate of delay damages under Sub-Clause 8.7 [Delay Damages] and shall not affect the maximum amount of these damages.

10.3 Interference with Tests on Completion

- 10.31 If the Contractor is prevented, for more than 14 days, from carrying out the Tests on Completion by a cause for which the Procuring Entity is responsible, the Procuring Entity shall be deemed to have taken over the Works or Section (as the case may be) on the date when the Tests on Completion would otherwise have been completed.
- 10.32 The Architect shall then issue a Taking-Over Certificate accordingly, and the Contractor shall carry out the Tests on Completion as soon as practicable, before the expiry date of the Defects Notification Period. The Architect shall require the Tests on Completion to be carried out by giving 14 days' notice and in accordance with the relevant provisions of the Contract.

- 10.3.3 If the Contractor suffers delay and/or incurs Cost as a result of this delay in carrying out the Tests on Completion, the Contractor shall give notice to the Architect and shall be entitled subject to Sub-Clause 20.1 [Contractor's Claims] to:
- a) an extension of time for any such delay, if completion is or will be delayed, under Sub-Clause 8.4 [Extension of Time for Completion], and
 - b) payment of any such accrued costs, which shall be included in the Contract Price.
- 10.3.4 After receiving this notice, the Architect shall proceed in accordance with Sub-Clause 3.5 [Determinations] to agree or determine these matters.

10.4 Surfaces Requiring Reinstatement

Except as otherwise stated in a Taking-Over Certificate, a certificate for a Section or part of the Works shall not be deemed to certify completion of any ground or other surfaces requiring reinstatement.

11. DEFECTS LIABILITY

11.1 Completion of Outstanding Work and Remedying Defects

- 11.1.1 In order that the Works and Contractor's Documents, and each Section, shall be in the condition required by the Contract (fair wear and tear excepted) by the expiry date of the relevant Defects Notification Period or as soon as practicable there after, the Contractor shall:
- a) complete any work which is outstanding on the date stated in a Taking-Over Certificate, within such reasonable time as is instructed by the Engineer, and
 - b) execute all work required to remedy defects or damage, as may be notified by (or on behalf of) the Procuring Entity on or before the expiry date of the Defects Notification Period for the Works or Section (as the case may be).

11.1.2 If a defect appears or damage occurs, the Contractor shall be notified accordingly by the Engineer.

11.2 Cost of Remedying Defects

- 11.2.1 All work referred to in sub-paragraph (b) of Sub-Clause 11.1 [Completion of Outstanding Work and Remedying Defects] shall be executed at the risk and cost of the Contractor, if and to the extent that the work is attributable to:
- a) Any design for which the Contractor is responsible,
 - b) Plant, Materials or workmanship not being in accordance with the Contract, or
 - c) Failure by the Contractor to comply with any other obligation.

11.2.2 If and to the extent that such work is attributable to any other cause, the Contractor shall be notified promptly by (or on behalf of) the Procuring Entity, and Sub-Clause 13.3 [Variation Procedure] shall apply.

11.3 Extension of Defects Notification Period

11.3.1 The Procuring Entity shall be entitled subject to Sub-Clause 2.5 [Procuring Entity's Claims] to an extension of the Defects Notification Period for the Works or a Section if and to the extent that the Works, Section or a major item of Plant (as the case may be, and after taking over) cannot be used for the purposes for which they are intended by reason of a defect or by reason of damage attributable to the Contractor. However, a Defects Notification Period shall not be extended by more than two years.

11.3.2 If delivery and/ or erection of Plant and/ or Materials was suspended under Sub-Clause 8.8 [Suspension of Work] or Sub-Clause 16.1 [Contractor's Entitlement to Suspend Work], the Contractor's obligations under this Clause shall not apply to any defects or damage occurring more than two years after the Defects Notification Period for the Plant and/ or Materials would otherwise have expired.

11.4 Failure to Remedy Defects

11.4.1 If the Contractor fails to remedy any defect or damage within a reasonable time, a date may be fixed by the Engineer, on or by which the defect or damage is to be remedied. The Contractor shall be given reasonable notice of this date.

- 11.42 If the Contractor fails to remedy the defect or damage by this notified date and this remedial work was to be executed at the cost of the Contractor under Sub-Clause 11.2 [Cost of Remedying Defects], the Procuring Entity may (at his option):
- (a) Carry out the work itself or by others, in a reasonable manner and at the Contractor's cost, but the Contractor shall have no responsibility for this work; and the Contractor shall be subject to Sub-Clause 2.5 [Procuring Entity's Claims] pay to the Procuring Entity the costs reasonably incurred by the Procuring Entity in remedying the defect or damage;
 - (b) Require the Architect to agree or determine a reasonable reduction in the Contract Price in accordance with Sub-Clause 3.5 [Determinations]; or
 - (c) if the defect or damage deprives the Procuring Entity of substantially the whole benefit of the Works or any major part of the Works, terminate the Contract as a whole, or in respect of such major part which cannot be put to the intended use. Without prejudice to any other rights, under the Contract otherwise, the Procuring Entity shall then be entitled to recover all sums paid for the Works or for such part (as the case may be), plus financing costs and the cost of dismantling the same, clearing the Site and returning Plant and Materials to the Contractor.

11.5 Removal of Defective Work

If the defect or damage cannot be remedied expeditiously on the Site and the Procuring Entity gives consent, the Contractor may remove from the Site for the purposes of repair such items of Plant as are defective or damaged. This consent may require the Contractor to increase the amount of the Performance Security by the full replacement cost of these items, or to provide other appropriate security.

11.6 Further Tests

- 11.6.1 If the work of remedying of any defect or damage may affect the performance of the Works, the Architect may require the repetition of any of the tests described in the Contract. The requirement shall be made by notice within 14 days after the defect or damage is remedied.
- 11.6.2 These tests shall be carried out in accordance with the terms applicable to the previous tests, except that they shall be carried out at the risk and cost of the Party liable, under Sub-Clause 11.2 [Cost of Remedying Defects], for the cost of the remedial work.

11.7 Right of Access

Until the Completion Certificate has been issued, the Contractor shall have such right of access to the Works as is reasonably required in order to comply with this Clause, except as may be inconsistent with the Procuring Entity's reasonable security restrictions.

11.8 Contractor to Search

The Contractor shall, if required by the Engineer, search for the cause of any defect or parts of the works that have already accepted, under the direction of the Engineer. Unless the defect is to be remedied at the cost of the Contractor under Sub-Clause 11.2 [Cost of Remedying Defects], the Cost of the search plus profit shall be agreed or determined by the Architect in accordance with Sub-Clause 3.5 [Determinations] and shall be included in the Contract Price.

11.9 Completion Certificate

- 11.9.1 Performance of the Contractor's obligations shall not be considered to have been completed until the Architect has issued the Completion Certificate to the Contractor, stating the date on which the Contractor completed his obligations under the Contract.
- 11.9.2 The Architect shall issue the Completion Certificate within 30 days after the latest of the expiry dates of the Defects Liability Period, or as soon thereafter as the Contractor has supplied all the Contractor's Documents and completed and tested all the Works, including remedying any defects. A copy of the Completion Certificate shall be issued to the Procuring Entity.
- 11.9.3 Only the Completion Certificate shall be deemed to constitute acceptance of the Works.

11.10 Unfulfilled Obligations

After the Completion Certificate has been issued, each Party shall remain liable for the fulfilment of any obligation which remains unperformed at that time. For the purposes of determining the nature and extent of unperformed obligations, the Contract shall be deemed to remain in force.

11.11 Clearance of Site

- 11.11.1 Upon receiving the Completion Certificate, the Contractor shall remove any remaining Contractor's Equipment, surplus material, wreckage, rubbish and Temporary Works from the Site.
- 11.11.2 If all these items have not been removed within 30 days after receipt by the Contractor of the Completion Certificate, the Procuring Entity may sell or otherwise dispose of any remaining items. The Procuring Entity shall be entitled to be paid the costs incurred in connection with, or attributable to, such sale or disposal and restoring the Site.
- 11.11.3 Any balance of the moneys from the sale shall be paid to the Contractor. If these moneys are less than the Procuring Entity's costs, the Contractor shall pay the outstanding balance to the Procuring Entity.

12 MEASUREMENT AND DEVALUATION

12.1 Works to be Measured

- 12.1.1 The Works shall be measured, and valued for payment, in accordance with this Clause. The Contractor shall show in each application under Sub-Clauses 14.3 [Application for Interim Payment Certificates], 14.10 [Statement on Completion] and 14.11 [Application for Final Payment Certificate] the quantities and other particulars detailing the amounts which he considers to be entitled under the Contract.
- 12.1.2 Whenever the Architect requires any part of the Works to be measured, reasonable notice shall be given to the Contractor's Representative, who shall:
- a) promptly either attend or send another qualified representative to assist the Architect in making the measurement, and
 - b) supply any particulars requested by the Engineer.
- 12.1.3 If the Contractor fails to attend or send a representative, the measurement made by the Architect shall be accepted as accurate.
- 12.1.4 Except as otherwise stated in the Contract, wherever any Permanent Works are to be measured from records, these shall be prepared by the Engineer. The Contractor shall, as and when requested, attend to examine and agree her records with the Engineer, and shall sign the same when agreed. If the Contractor does not attend, the records shall be accepted as accurate.
- 12.1.5 If the Contractor examines and disagrees the records, and/ or does not sign them as agreed, then the Contractor shall give notice to the Architect of the respects in which the records are asserted to be inaccurate. After receiving this notice, the Architect shall review the records and either confirm or vary them and certify the payment of the undisputed part. If the Contractor does not so give notice to the Architect within 14 days after being requested to examine the records, they shall be accepted as accurate.

12.2 Method of Measurement

Except as otherwise stated in the Contract:

- a) Measurement shall be made of the net actual quantity of each item of the Permanent Works, and
- b) the method of measurement shall be in accordance with the Bill of Quantities or other applicable Schedules.

12.3 Evaluation

- 12.3.1 Except as otherwise stated in the Contract, the Architect shall proceed in accordance with Sub-Clause 3.5 [Determinations] to agree or determine the value of work done by evaluating each item of work, applying the measurement agreed or determined in accordance with the above Sub-Clauses 12.1 and 12.2 and the appropriate rate or price for the item.

- 12.32 For each item of work, the appropriate rate or price for the item shall be the rate or price specified for such item in the Contractor, if there is no such item, specified for similar work.
- 12.33 Any item of work included in the Bill of Quantities for which no rate or price was specified shall be considered as included in other rates and prices in the Bill of Quantities and will not be paid for separately.
- 12.34 However, for a new item of work, a new rate or price shall be appropriate for such item of work if:
- a) The work is instructed under Clause 13 [Variations and Adjustments],
 - b) no rate or price is specified in the Contract for this item, and
 - c) no specified rate or price is appropriate because the item of work is not of similar character, or is not executed under similar conditions, as any item in the Contract.
- 12.35 Each new rate or price shall be derived from any relevant rates or prices in the Contract. If no rates or prices are relevant for the new item of work, it shall be derived from the reasonable Cost of executing such work, prevailing market rates, together with profit, taking account of any other relevant matters.
- 12.36 Until such time as an appropriate rate or price is agreed or determined, the Architect shall determine a provisional rate or price for the purposes of Interim Payment Certificates as soon as the concerned work commences.
- 12.37 Where the contract price is different from the corrected tender price, in order to ensure the contractor is not paid less or more relative to the contract price (*which would be the tender price*), payment valuation certificates and variation orders on omissions and additions valued based on rates in the Bill of Quantities or schedule of rates in the Tender, will be adjusted by a plus or minus percentage. The percentage already worked out during tender evaluation is worked out as follows: $(\text{corrected tender price} - \text{tender price}) / \text{tender price} \times 100$.

12.4 Omissions

Whenever the omission of any work forms part (or all) of a Variation, the value of which has not been agreed, if:

- a) The Contractor will incur (or has incurred) cost which, if the work had not been omitted, would have been deemed to be covered by a sum forming part of the Accepted Contract Amount;
- b) The omission of the work will result (or has resulted) in this sum not forming part of the Contract Price; and
- c) this cost is not deemed to be included in the evaluation of any substituted work; then the Contractor shall give notice to the Architect accordingly, with supporting particulars. Upon receiving this notice, the Architect shall proceed in accordance with Sub-Clause 3.5 [Determinations] to agree or determine this cost, which shall be included in the Contract Price.

13 VARIATIONS AND ADJUSTMENTS

13.1 Right to Vary

- 13.1.1 Variations may be initiated by the Architect at any time prior to issuing the Taking-Over Certificate for the Works, either by an instruction or by a request for the Contractor to submit a proposal. No Variation instructed by the Architect under this Clause shall in any way vitiate or invalidate the Contract.
- 13.1.2 The Contractor shall execute and be bound by each Variation, unless the Contractor promptly gives notice to the Architect stating (with supporting particulars) that (i) the Contractor cannot readily obtain the Goods required for the Variation, or (ii) such Variation triggers a substantial change in the sequence or progress of the Works. Upon receiving this notice, the Architect shall cancel, confirm or vary the instruction.
- 13.1.3 Each Variation may include:
- a) changes to the quantities of any item of work included in the Contract (however, such changes do not necessarily constitute a Variation),
 - b) changes to the quality and other characteristics of any item of work,
 - c) changes to the levels, positions and/ or dimensions of any part of the Works,
 - d) omission of any work unless it is to be carried out by others,
 - e) any additional work, Plant, Materials or services necessary for the Permanent Works, including any associated Tests on Completion, boreholes and other testing and exploratory work, or
 - f) changes to the sequence or timing of the execution of the Works.

13.14 The Contractor shall not make any alteration and/or modification of the Permanent Works, unless and until the Architect instructs after obtaining approval of the Procuring Entity.

132 Variation Order Procedure

132.1 Prior to any Variation Order under Sub-Clause 13.1.4 the Architect shall notify the Contractor of the nature and form of such variation. As soon as possible after having received such notice, the Contractor shall submit to the Engineer:

- a) A description of work, if any, to be performed and a programme for its execution, and
- b) the Contractor's proposals for any necessary modifications to the Programme according to Sub-Clause 8.3 or to any of the Contractor's obligations under the Contract, and
- c) the Contractor's proposals for adjustment to the Contract Price.

Following the receipt of the Contractor's submission the Architect shall, after due consultation with the Employer and the Contractor, decide as soon as possible whether or not the variation shall be carried out. If the Architect decides that the variation shall be carried out, he shall issue a Variation Order clearly identified as such in accordance with the Contractor's submission or as modified by agreement.

If the Architect and the Contractor are unable to agree the adjustment of the Contract Price, the provisions of Sub-Clause 13.2.2 shall apply.

132.2 Disagreement on Adjustment of the Contract Price

If the Contractor and the Architecture unable to agree on the adjustment of the Contract Price, the adjustment shall be determined in accordance with the rates specified in the Bills of Quantities or Schedule of Daywork Prices. If the rates contained in the Bills of Quantities or Dayworks Prices are not directly applicable to the specific work in question, suitable rates shall be established by the Architect reflecting the level of pricing in the Dayworks Prices. Where rates are not contained in the said Prices, the amount shall be such as is in all the circumstances reasonable, reflecting a market price. Due account shall be taken of any over-or under-recovery of overheads by the Contractor in consequence of the variation. The Contractor shall also be entitled to be paid:

- a) The cost of any partial execution of the Work rendered useless by any such variation,
- b) The cost of making necessary alterations to Plant already manufactured or in the course of manufacture or of any work done that has to be altered in consequence of such a variation,
- c) any additional costs incurred by the Contractor by the disruption of the progress of the Works as detailed in the Programme, and
- d) the net effect of the Contractor's finance costs, including interest, caused by the variation.

The Architect shall on this basis determine the rates or prices to enable on-account payment to be included in certificates of payment.

132.3 Contractor to Proceed

On receipt of a Variation Order, the Contractor shall forth with proceed to carry out the variation and be bound to these Conditions in so doing as if such variation was stated in the Contract. The work shall not be delayed pending the granting of an extension of the Time for Completion or an adjustment to the Contract Price under Sub-Clause 31.3.

133 Value Engineering

133.1 The Contractor may, at anytime, submit to the Architect written proposal which (in the Contractor's opinion) will, if adopted, (i) accelerate completion, (ii) reduce the cost to the Procuring Entity of executing, maintaining or operating the Works, (iii) improve the efficiency or value to the Procuring Entity of the completed Works, or
(iv) otherwise be of benefit to the Procuring Entity.

133.2 The proposal shall be prepared at the cost of the Contractor and shall include the items listed in Sub-Clause 13.3 [Variation Procedure].

132.3 If a proposal, which is approved by the Engineer, includes a change in the design of part of the Permanent Works, then unless otherwise agreed by both Parties:

- a) The Contractor shall design this part,

- b) sub-paragraphs (a) to (d) of Sub-Clause 4.1 [Contractor's General Obligations] shall apply, and
- c) if this change results in a reduction in the contract value of this part, the Architect shall proceed in accordance with Sub-Clause 3.5 [Determinations] to agree or determine a fee, which shall be included in the Contract Price. This fee shall be half (50%) of the difference between the following amounts:
 - i) such reduction in contract value, resulting from the change, excluding adjustments under Sub-Clause 13.8 [Adjustments for Changes in Legislation] and Sub-Clause 13.8 [Adjustments for Changes in Cost], and
 - ii) the reduction (if any) in the value to the Procuring Entity of the varied works, taking account of any improvement in quality, anticipated life or operational efficiencies.

13.3.4 However, if the amount established in item 13.2.3 (c) (i) is less than amount established in item 13.2.3 (c) (ii), there shall not be a fee. However, if the if the amount established in item 13.2.3 (c) (i) is more than amount established in item 13.2.3 (c) (ii), it shall result in a price variation to the Procuring Entity.

134 Variation Procedure for Value Engineering proposal

- 134.1 If the Architect requests a proposal, prior to instructing a Variation, the Contractor shall respond in writing as soon as practicable, either by giving reasons why he cannot comply (if this is the case) or by submitting:
- a) A description of the proposed work to be performed and a programme for its execution,
 - b) the Contractor's proposal for any necessary modifications to the programme according to Sub-Clause 8.3 [Programme] and to the Time for Completion, and
 - c) the Contractor's proposal for evaluation of the Variation.
- 134.2 The Architect shall, as soon as practicable after receiving such proposal (under Sub-Clause 13.2 [Value Project Engineering] or otherwise), respond with approval, disapproval or comments. The Contractor shall not delay any work whilst a waiting a response.
- 134.3 Each instruction to execute a Variation, with any requirements for the recording of Costs, shall be issued by the Architect to the Contractor, who shall acknowledge receipt.
- 134.4 Each Variation shall be evaluated in accordance with Clause 12 [Measurement and Evaluation], unless the Architect instructs or approves otherwise in accordance with this Clause.

135 Payment in Applicable Currencies

If the Contract provides for payment of the Contract Price in more than one currency, then whenever an adjustment is agreed, approved or determined as stated above, the amount payable in each of the applicable currencies shall be specified. For this purpose, reference shall be made to the actual or expected currency proportions of the Cost of the varied work, and to the proportions of various currencies specified for payment of the Contract Price.

136 Provisional Sums

- 136.1 Each Provisional Sum shall only be used, in whole or in part, in accordance with the Architect instructions, and the Contract Price shall be adjusted accordingly. The total sum paid to the Contractor shall include only such amounts, for the work, supplies or services to which the Provisional Sum relates, as the Architect shall have instructed. For each Provisional Sum, the Architect May instruct:
- a) Work to be executed (including Plant, Materials or services to be supplied) by the Contractor and valued under Sub-Clause 13.3 [Variation Procedure]; and/or
 - b) Plant, Materials or services to be purchased by the Contractor, from a nominated Subcontractor (as defined in Clause 5 [Nominated Subcontractors]) or otherwise; and for which there shall be included in the Contract Price:
 - i) The actual amounts paid (or due to be paid) by the Contractor, and
 - ii) a sum for overhead charges and profit, calculated as a percentage of these actual amounts by applying the relevant percentage rate (if any) stated in the appropriate Schedule. If there is no such rate, the percentage rate stated in **the Special Conditions of Contract** shall be applied.
- 136.2 The Contractor shall, when required by the Engineer, produce quotations, invoices, vouchers and accounts or receipts in substantiation.

137 Dayworks

- 13.7.1 For work of a minor or incidental nature, the Architect may instruct that a Variation shall be executed on a daywork basis. The work shall then be valued in accordance with the Daywork Schedule included in the Contract, and the following procedure shall apply. If a Daywork Schedule is not included in the Contract, this Sub-Clause shall not apply.
- 13.7.2 Before ordering Goods for the work, the Contractor shall submit quotations to the Engineer. When applying for payment, the Contractor shall submit invoices, vouchers and accounts or receipts for any Goods.
- 13.7.3 Except for any items for which the Daywork Schedule specifies that payment is not due, the Contractor shall deliver each day to the Architect accurate statements induplicate which shall include the following details of the resources used in executing the previous day's work:
- a) The names, occupations and time of Contractor's Personnel,
 - b) the identification, type and time of Contractor's Equipment and Temporary Works, and
 - c) the quantities and types of Plant and Materials used.
- 13.7.4 One copy of each statement will, if correct, or when agreed, be signed by the Architect and returned to the Contractor. The Contractor shall then submit priced statements of these resources to the Engineer, prior to their inclusion in the next Statement under Sub-Clause 14.3 [Application for Interim Payment Certificates].

138 Adjustments for Changes in Legislation

- 13.8.1 The Contract Price shall be adjusted to take account of any increase or decrease in Cost resulting from a change in the Laws of Kenya (including the introduction of new Laws and the repeal or modification of existing Laws) or in the judicial or official governmental interpretation of such Laws, made after the Base Date, which affect the Contractor in the performance of obligations under the Contract.
- 13.8.2 If the Contractor suffers (or will suffer) delay and/or incurs (or will incur) additional Cost as a result of these changes in the Laws or in such interpretations, made after the Base Date, the Contractor shall give notice to the Architect and shall be entitled subject to Sub-Clause 20.1 [Contractor's Claims] to:
- a) an extension of time for any such delay, if completion is or will be delayed, under Sub-Clause 8.4 [Extension of Time for Completion], and
 - b) payment of any such Cost, which shall be included in the Contract Price.
- 13.8.3 After receiving this notice, the Architect shall proceed in accordance with Sub-Clause 3.5 [Determinations] to agree or determine these matters.
- 13.8.4 Notwithstanding the foregoing, the Contractor shall not be entitled to an extension of time if the relevant delay has already been taken into account in the determination of a previous extension of time and such Cost shall not be separately paid if the same shall already have been taken into account in the indexing of any inputs to the table of adjustment data in accordance with the provisions of Sub-Clause 13.8 [Adjustments for Changes in Cost].

139 Adjustments for Changes in Cost

- 13.9.1 In this Sub-Clause, "table of adjustment data" means the completed table of adjustment data for local and foreign currencies included in the Schedules. If there is no such table of adjustment data, this Sub-Clause shall not apply.
- 13.9.2 If this Sub-Clause applies, the amounts payable to the Contractor shall be adjusted for rises or falls in the cost of labor, Goods and other inputs to the Works, by the addition or deduction of the amounts determined by the formulae prescribed in this Sub-Clause. To the extent that full compensation for any rise or fall in Costs is not covered by the provisions of this or other Clauses, the Accepted Contract Amount shall be deemed to have included amounts to cover the contingency of other rises and falls in costs.
- 13.9.3 The adjustment to be applied to the amount otherwise payable to the Contractor, as valued in accordance with the appropriate Schedule and certified in Payment Certificates, shall be determined from formulae for each of the currencies in which the Contract Price is payable. No adjustment is to be applied to work valued on the basis of Cost or current prices. The formulae shall be of the following general type:

Price Adjustment Formula

Prices shall be adjusted for fluctuations in the cost of inputs only if **provided for in the SCC**. If so provided, the amounts certified in each payment certificate, before deducting for Advance Payment, shall be adjusted by applying the respective price adjustment factor to the payment amounts due in each currency. A separate formula of the type specified below applies:

$$P = A + B \text{ Im/Io}$$

where:

P is the adjustment factor for the portion of the Contract Price payable.

A and **B** are coefficients **specified in the SCC**, representing then on adjustable and adjustable portions, respectively, of the Contract Price payable and

Im is the index prevailing at the end of the month being invoiced and **Ioc** is the index prevailing 30 days before Bid opening for inputs payable.

NOTE: The sum of the two coefficients A and B should be 1 (one) in the formula for each currency. Normally, both coefficients shall be the same in the formulae for all currencies, since coefficient A, for the non adjustable portion of the payments, is a very approximate figure (usually 0.15) to take account of fixed cost elements or other nonadjustable components. The sum of the adjustments for each currency are added to the Contract Price.

- 1394 The cost indices or reference prices stated in the table of adjustment data shall be used. If their source is in doubt, it shall be determined by the Engineer. For this purpose, reference shall be made to the values of the indices at stated dates (quoted in the fourth and fifth columns respectively of the table) for the purposes of clarification of the source; although these dates (and thus these values) may not correspond to the base cost indices.
- 1395 Incases where the “currency of index” is not the relevant currency of payment, each index shall be converted into the relevant currency of payment at the selling rate, established by the Central Bank of Kenya, of this relevant currency on the above date for which the index is required to be applicable.
- 1396 Until such time as each current cost index is available, the Architect shall determine a provisional index for the issue of Interim Payment Certificates. When a current cost index is available, the adjustment shall be recalculated accordingly.
- 1397 If the Contractor fails to complete the Works within the Time for Completion, adjustment of prices there after shall be made using either (i) each index or price applicable on the date 49 days prior to the expiry of the Time for Completion of the Works, or (ii) the current index or price, whichever is more favorable to the Procuring Entity.
- 1398 The weightings (coefficients) for each of the factors of cost stated in the table(s) of adjustment data shall only be adjusted if they have been rendered unreasonable, unbalanced or inapplicable, as a result of Variations.

14 CONTRACT PRICE AND PAYMENT

14.1 The Contract Price

14.1.1 Unless otherwise stated in the Special Conditions:

- a) The value of the payment certificate shall be agreed or determined under Sub-Clause 12.3 [Evaluation] and be subject to adjustments in accordance with the Contract;
- b) the Contractor shall pay all taxes, duties and fees required to be paid by him under the Contract, and the Contract Price shall not be adjusted for any of these costs except as stated in Sub-Clause 13.7 [Adjustments for Changes in Legislation];
- c) any quantities which may be set out in the Bill of Quantities or other Schedule are estimated quantities and are not to be taken as the actual and correct quantities:

- i) of the Works which the Contractor is required to execute, or
 - ii) for the purposes of Clause 12 [Measurement and Evaluation]; and
- d) the Contractor shall submit to the Engineer, within 30 days after the Commencement Date, a proposed breakdown of each lump sum price in the Schedules. The Architect may take account of the break down when preparing Payment Certificates but shall not be bound by it.

14.1.2 Notwithstanding the provisions of subparagraph (b), Contractor's Equipment, including essential spare parts there for, imported by the Contractor for the sole purpose of executing the Contract shall not be exempt from the payment of import duties and taxes upon importation.

14.2 Advance Payment

14.2.1 The Procuring Entity shall make an advance payment, as an interest-free loan for mobilization and cashflow support, when the Contractor submits a guarantee in accordance with this Clause. The total advance payment, the number and timing of instalments (if more than one), and the applicable currencies and proportions, shall be as stated in the **Special Conditions of Contract**.

14.2.2 Unless and until the Procuring Entity receives this guarantee, or if the total advance payment is not stated in the Special Conditions of Contract, this Sub-Clause shall not apply.

14.2.3 The Architect shall deliver to the Procuring Entity and to the Contractor an Interim Payment Certificate for the advance payment or its first instalment after receiving a Statement (under Sub-Clause 14.3 [Application for Interim Payment Certificates]) and after the Procuring Entity receives (i) the Performance Security in accordance with Sub-Clause 4.2 [Performance Security] and (ii) a guarantee in amounts and currencies equal to the advance payment. This guarantee shall be issued by a reputable bank or financial institutions elected by the Contractor and shall be in the form annexed to the Special Conditions or in another form approved by the Procuring Entity.

14.2.4 The Contractor shall ensure that the guarantee is valid and enforceable until the advance payment has been repaid, but its amount shall be progressively reduced by the amount repaid by the Contractor as indicated in the Payment Certificates. If the terms of the guarantee specify its expiry date, and the advance payment has not been repaid by the date 30 days prior to the expiry date, the Contractor shall extend the validity of the guarantee until the advance payment has been repaid.

14.2.5 Unless stated otherwise in **the Special Conditions of Contract**, the advance payment shall be repaid through percentage deductions from the interim payments determined by the Architect in accordance with Sub-Clause 14.6 [Issue of Interim Payment Certificates], as follows:

- a) Deductions shall commence in the next interim Payment Certificate following that in which the total of all certified interim payments (excluding the advance payment and deductions and repayments of retention) exceeds 30 percent (30%) of the Accepted Contract Amount less Provisional Sums; and
- b) deductions shall be made at the amortization rate stated in the **Special Conditions of Contract** of the amount of each Interim Payment Certificate (excluding the advance payment and deductions for its repayments as well as deductions for retention money) in the currencies and proportions of the advance payment until such time as the advance payment has been repaid; provided that the advance payment shall be completely repaid prior to the time when 90 percent (90%) of the Accepted Contract Amount less Provisional Sums has been certified for payment.

14.2.6 If the advance payment has not been repaid prior to the issue of the Taking-Over Certificate for the Works or prior to termination under Clause 15 [Termination by Procuring Entity], Clause 16 [Suspension and Termination by Contractor] or Clause 19 [Force Majeure] (as the case may be), the whole of the balance then outstanding shall immediately become due and in case of termination under Clause 15 [Termination by Procuring Entity], except for Sub-Clause 14.2.7 [Procuring Entity's Entitlement to Termination for Convenience], payable by the Contractor to the Procuring Entity.

143 Application for Interim Payment Certificates

- 143.1 The Contractor shall submit a Statement (in number of copies indicated in the **Special Conditions of Contract**) to the Architect after the end of each month, in a form approved by the Engineer, showing in detail the amounts to which the Contractor considers itself to be entitled, together with supporting documents which shall include the report on the progress during this month in accordance with Sub-Clause 4.21 [Progress Reports].
- 143.2 The Statement shall include the following items, as applicable, which shall be expressed in the various currencies in which the Contract Price is payable, in the sequence listed:
- a) the estimated contract value of the Works executed and the Contractor's Documents produced up to the end of the month (including Variations but excluding items described in sub-paragraphs (b) to (g) below);
 - b) any amounts to be added and deducted for changes in legislation and changes in cost, in accordance with Sub-Clause 13.7 [Adjustments for Changes in Legislation] and Sub-Clause 13.8 [Adjustments for Changes in Cost];
 - c) any amount to be deducted for retention, calculated by applying the percentage of retention stated in **the Special Conditions of Contract** to the total of the above amounts, until the amount so retained by the Procuring Entity reaches the limit of Retention Money (if any) stated **in the Special Conditions of Contract**;
 - d) any amounts to be added for the advance payment and (if more than one instalment) and to be deducted for its repayments in accordance with Sub-Clause 14.2 [Advance Payment];
 - e) any amounts to be added and deducted for Plant and Materials in accordance with Sub-Clause 14.5 [Plant and Materials intended for the Works];
 - f) any other additions or deductions which may have become due under the Contract otherwise, including those under Clause 20 [Claims, Disputes and Arbitration]; and
 - g) the deduction of amounts certified in all previous Payment Certificates.

144 Schedule of Payments

- 144.1 If the Contract includes a schedule of payments specifying the instalments in which the Contract Price will be paid, then unless otherwise stated in this schedule:
- a) The instalments quoted in this schedule of payments shall be the estimated contract values for the purposes of sub-paragraph (a) of Sub-Clause 14.3 [Application for Interim Payment Certificates];
 - b) Sub-Clause 14.5 [Plant and Materials intended for the Works] shall not apply; and
 - c) If these instalments are not defined by reference to the actual progress achieved in executing the Works, and if actual progress is found to be less or more than that on which this schedule of payments was based, then the Architect may proceed in accordance with Sub-Clause 3.5 [Determinations] to agree or determine revised instalments, which shall take account of the extent to which progress is less or more than that on which the instalments were previously based.
- 144.2 If the Contract does not include a schedule of payments, the Contractor shall submit non-binding estimates of the payments which he expects to become due during each quarterly period. The first estimate shall be submitted within 42 days after the Commencement Date. Revised estimates shall be submitted at quarterly intervals, until the Taking-Over Certificate has been issued for the Works.

145 Plant and Materials intended for the Works

- 145.1 If this Sub-Clause applies, Interim Payment Certificates shall include, under sub-paragraph (e) of Sub-Clause 14.3, (i) an amount for Plant and Materials which have been sent to the Site for incorporation in the Permanent Works, and (ii) a reduction when the contract value of such Plant and Materials is included as part of the Permanent Works under sub-paragraph (a) of Sub-Clause 14.3 [Application for Interim Payment Certificates].
- 145.2 If the lists referred to in sub-paragraphs (b)(i) or (c)(i) below are not included in the Schedules, this Sub-Clause shall not apply.

- 14.53 The Architect shall determine and certify each addition if the following conditions are satisfied:
- a) The Contractor has:
 - i) kept satisfactory records (including the orders, receipts, Costs and use of Plant and Materials) which are available for inspection, and
 - ii) submitted statement of the Cost of acquiring and delivering the Plant and Materials to the Site, supported by satisfactory evidence;and either:
 - b) the relevant Plant and Materials:
 - i) are those listed in the Schedules for payment when shipped,
 - ii) have been shipped to Kenya, enroute to the Site, in accordance with the Contract; and
 - iii) are described in a clean shipped bill of lading or other evidence of shipment, which has been submitted to the Architect together with evidence of payment of freight and insurance, any other documents reasonably required, and a bank guarantee in a form and issued by an entity approved by the Procuring Entity in amounts and currencies equal to the amount due under this Sub-Clause: this guarantee may be in a similar form to the form referred to in Sub-Clause 14.2 [Advance Payment] and shall be valid until the Plant and Materials are properly stored on Site and protected against loss, damage or deterioration; or
 - c) the relevant Plant and Materials:
 - i) are those listed in the Schedules for payment when delivered to the Site, and
 - ii) have been delivered to and are properly stored on the Site, are protected against loss, damage or deterioration and appear to be in accordance with the Contract.
- 14.54 The additional amount to be certified shall be the equivalent of eighty percent (80%) of the Architect determination of the cost of the Plant and Materials (including delivery to Site), taking account of the documents mentioned in this Sub-Clause and of the contract value of the Plant and Materials.
- 14.55 The currencies for this additional amount shall be the same as those in which payment will become due when the contract value is included under sub-paragraph (a) of Sub-Clause 14.3 [Application for Interim Payment Certificates]. At that time, the Payment Certificate shall include the applicable reduction which shall be equivalent to, and in the same currencies and proportions as, this additional amount for the relevant Plant and Materials.
- 146 Issue of Interim Payment Certificates**
- 14.61 No amount will be certified or paid until the Procuring Entity has received and approved the Performance Security. Thereafter, the Architect shall, within 30 days after receiving a Statement and supporting documents, deliver to the Procuring Entity and to the Contractor an Interim Payment Certificate which shall state the amount which the Architect fairly determines to be due, with all supporting particulars for any reduction or withholding made by the Architect on the Statement if any.
- 14.62 However, prior to issuing the Taking-Over Certificate for the Works, the Architect shall not be bound to issue an Interim Payment Certificate in an amount which would (after retention and other deductions) be less than the minimum amount of Interim Payment Certificates (if any) stated **in the Special Conditions of Contract**. In this event, the Architect shall give notice to the Contractor accordingly.
- 14.63 An Interim Payment Certificate shall not be withheld for any other reason, although:
- a) if anything supplied or work done by the Contractor is not in accordance with the Contract, the cost of rectification or replacement may be withheld until rectification or replacement has been completed; and/or
 - b) if the Contractor was or is failing to perform any work or obligation in accordance with the Contract, and had been so notified by the Engineer, the value of this work or obligation may be withheld until the work or obligation has been performed.
- 14.64 The Architect may in any Payment Certificate make any correction or modification that should properly be made to any previous Payment Certificate. A Payment Certificate shall not be deemed to indicate the Architect acceptance, approval, consent or satisfaction.

14.7 Payment

14.7.1 The Procuring Entity shall pay to the Contractor:

- a) The advance payment shall be paid within 60 days after signing of the contract by both parties or within 60 days after receiving the documents in accordance with Sub-Clause 4.2 [Performance Security] and Sub-Clause 14.2 [Advance Payment], whichever is later;
- b) The amount certified in each Interim Payment Certificate within 60 days after the Architect Issues Interim Payment Certificate; and
- c) the amount certified in the Final Payment Certificate within 60 days after the Procuring Entity Issues Interim Payment Certificate; or after determination of any disputed amount shown in the Final Statement in accordance with Sub-Clause 16.2 [Termination by Contractor].

14.7.2 Payment of the amount due in each currency shall be made into the bank account, nominated by the Contractor, in the payment country (forth is currency) specified in the Contract.

14.8 Delayed Payment

14.8.1 If the Contractor does not receive payment in accordance with Sub-Clause 14.7 [Payment], the Contractor shall be entitled to receive financing charges (simple interest) monthly on the amount unpaid during the period of delay. This period shall be deemed to commence on the date for payment specified in Sub-Clause 14.7 [Payment], irrespective (in the case of its sub-paragraph (b) of the date on which any Interim Payment Certificate is issued.

14.8.2 These financing charges shall be calculated at the annual rate of three percentage points above the mean rate of the Central Bank in Kenya of the currency of payment, or if not available, the inter bank offered rate, and shall be paid in such currency.

14.8.3 The Contractor shall be entitled to this payment without formal notice and certification, and without prejudice to any other right or remedy.

14.9 Payment of Retention Money

14.9.1 When the Taking-Over Certificate has been issued for the Works, the first half of the Retention Money shall be certified by the Architect for payment to the Contractor. If a Taking-Over Certificate is issued for a Section or part of the Works, a proportion of the Retention Money shall be certified and paid. This proportion shall be half (50%) of the proportion calculated by dividing the estimated contract value of the Section or part, by the estimated final Contract Price.

14.9.2 Promptly after the latest of the expiry dates of the Defects Liability Periods, the outstanding balance of the Retention Money shall be certified by the Architect for payment to the Contractor. If a Taking-Over Certificate was issued for a Section, a proportion of the second half of the Retention Money shall be certified and paid promptly after the expiry date of the Defects Notification Period for the Section. This proportion shall be half (50%) of the proportion calculated by dividing the estimated contract value of the Section by the estimated final Contract Price.

14.9.3 However, if any work remains to be executed under Clause 11 [Defects Liability], the Architects shall be entitled to withhold certification of the estimated cost of this work until it has been executed.

14.9.4 When calculating these proportions, no account shall be taken of any adjustments under Sub-Clause 13.7 [Adjustments for Changes in Legislation] and Sub-Clause 13.8 [Adjustments for Changes in Cost].

14.9.5 Unless otherwise stated in the Special Conditions, when the Taking-Over Certificate has been issued for the Works and the first half of the Retention Money has been certified for payment by the Engineer, the Contractor shall be entitled to substitute a Retention Money Security guarantee, in the form annexed to the Special Conditions or in another form approved by the Procuring Entity and issued by a reputable bank or financial institution selected by the Contractor, for the second half of the Retention Money.

14.96 The Procuring Entity shall return the Retention Money Security guarantee to the Contractor within 14 days after receiving a copy of the Completion Certificate.

14.10 Statement at Completion

14.10.1 Within 84 days after receiving the Taking-Over Certificate for the Works, the Contractor shall submit to the Architect three copies of a Statement at completion with supporting documents, in accordance with Sub-Clause 14.3 [Application for Interim Payment Certificates], showing:

- a) the value of all work done in accordance with the Contract up to the date stated in the Taking-Over Certificate for the Works,
- b) any further sums which the Contractor considers to be due, and
- c) an estimate of any other amounts which the Contractor considers will become due to him under the Contract. Estimated amounts shall be shown separately in this Statement at completion.

14.10.2 The Architect shall then certify in accordance with Sub-Clause 14.6 [Issue of Interim Payment Certificates].

14.11 Application for Final Payment Certificate

14.11.1 Within 60 days after receiving the Completion Certificate, the Contractor shall submit, to the Engineer, six copies of a draft final statement with supporting documents showing in detail in a form approved by the Engineer:

- a) The value of all work done in accordance with the Contract, and
- b) Any further sums which the Contractor considers to be due to him under the Contract otherwise.

14.11.2 If the Architect disagrees with or cannot verify any part of the draft final statement, the Contractor shall submit such further information as the Architect may reasonably require within 30 days from receipt of said draft and shall make such changes in the draft as may be agreed between them. The Contractor shall then prepare and submit to the Architect the final statement as agreed. This agreed statement is referred to in these Conditions as the "Final Statement".

14.11.3 However, if, following discussions between the Architect and the Contractor and any changes to the draft final statement which are agreed, it becomes evident that a dispute exists, the Architect shall deliver to the Procuring Entity (with a copy to the Contractor) an Interim Payment Certificate for the agreed parts of the draft final statement. Thereafter, if the dispute is finally resolved under Sub-Clause 20.4 [Obtaining Dispute Board's Decision] or Sub-Clause 20.5 [Amicable Settlement], the Contractor shall then prepare and submit to the Procuring Entity (with a copy to the Engineer) a Final Statement.

14.12 Discharge

When submitting the Final Statement, the Contractor shall submit a discharge which confirms that the total of the Final Statement represents full and final settlement of all moneys due to the Contractor under or in connection with the Contract. This discharge may state that it becomes effective when the Contractor has received the Performance Security and the out standing balance of this total, in which event the discharge shall be effective on such date.

14.13 Issue of Final Payment Certificate

14.13.1 Within 30 days after receiving the Final Statement and discharge in accordance with Sub-Clause 14.11 [Application for Final Payment Certificate] and Sub-Clause 14.12 [Discharge], the Architect shall deliver, to the Procuring Entity and to the Contractor, the Final Payment Certificate which shall state:

- a) The amount which he fairly determines is finally due, and
- b) After giving credit to the Procuring Entity for all amounts previously paid by the Procuring Entity and for all sums to which the Procuring Entity is entitled, the balance (if any) due from the Procuring Entity to the Contractor or from the Contractor to the Procuring Entity, as the case may be.

14.13.2 If the Contractor has not applied for a Final Payment Certificate in accordance with Sub-Clause 14.11 [Application for Final Payment Certificate] and Sub-Clause 14.12 [Discharge], the Architect shall request the Contractor to do so. If the Contractor fails to submit an application within a period of 30 days, the Architect shall issue the Final Payment Certificate for such amount as he fairly determines to be due.

14.14 Cessation of Procuring Entity's Liability

- 14.14.1 The Procuring Entity shall not be liable to the Contractor for any matter or thing under or in connection with the Contract or execution of the Works, except to the extent that the Contractor shall have included an amount expressly for it:
- a) in the Final Statement and also,
 - b) (except for matters or things arising after the issue of the Taking-Over Certificate for the Works) in the Statement at completion described in Sub-Clause 14.10 [Statement at Completion].
- 14.14.2 However, this Sub-Clause shall not limit the Procuring Entity's liability under his in demnification obligations, or the Procuring Entity's liability in any case of fraud, deliberate default or reckless misconduct by the Procuring Entity.

14.15 Currencies of Payment

The Contract Price shall be paid in the currency or currencies named in the Schedule of Payment Currencies. If more than one currency is so named, payments shall be made as follows:

- a) If the Accepted Contract Amount was expressed in Local Currency only:
 - i) the proportions or amounts of the Local and Foreign Currencies, and the fixed rates of exchange to be used for calculating the payments, shall be as stated in the Schedule of Payment Currencies, except as otherwise agreed by both Parties;
 - ii) payments and deductions under Sub-Clause 13.5 [Provisional Sums] and Sub-Clause 13.7 [Adjustments for Changes in Legislation] shall be made in the applicable currencies and proportions; and
 - iii) other payments and deductions under sub-paragraphs (a) to (d) of Sub-Clause 14.3 [Application for Interim Payment Certificates] shall be made in the currencies and proportions specified in sub-paragraph (a) (i) above;
- b) payment of the damages specified in the Special Conditions of Contract, shall be made in the currencies and proportions specified in the Schedule of Payment Currencies;
- c) other payments to the Procuring Entity by the Contractor shall be made in the currency in which the sum was expended by the Procuring Entity, or in such currency as may be agreed by both Parties;
- d) if any amount payable by the Contractor to the Procuring Entity in a particular currency exceeds the sum payable by the Procuring Entity to the Contractor in that currency, the Procuring Entity may recover the balance of this amount from the sums otherwise payable to the Contractor in other currencies; and
- e) if no rates of exchange are stated in the Schedule of Payment Currencies, they shall be those prevailing on the Base Date and determined by the Central Bank of Kenya.

15 TERMINATION BY PROCURING ENTITY

15.1 Notice to correct any defects or failures

If the Contractor fails to carry out any obligation under the Contract, the Architect may by notice require the Contractor to make good the failure and to remedy it within 30 days.

15.2 Termination by Procuring Entity

- 15.2.1 The Procuring Entity shall be entitled to terminate the Contract if the Contractor breaches the contract based on following circumstances which shall include but not limited to:
- a) fails to comply with Sub-Clause 4.2 [Performance Security] or with a notice under Sub-Clause 15.1 [Notice to Correct],
 - b) abandons the Works or otherwise plainly demonstrates the intention not to continue performance of his obligations under the Contract,

- c) without reasonable excuse fails:
 - i) to proceed with the Works in accordance with Clause 8 [Commencement, Delays and Suspension], or
 - ii) to comply with a notice issued under Sub-Clause 7.5 [Rejection] or Sub-Clause 7.6 [Remedial Work], within 30 days after receiving it,
- d) subcontracts the major part or whole of the Works or assigns the Contract without the consent of the Procuring Entity,
- e) becomes bankrupt or insolvent, goes into liquidation, has a receiving or administration order made against him, compounds with his creditors, or carries on business under a receiver, trustee or manager for the benefit of his creditors, or if any act is done or event occurs which (under applicable Laws) has a similar effect to any of these acts or events, or
- f) gives or offers to give (directly or indirectly) to any person any bribe, gift, gratuity, commission or other thing of value, as an induce mentor reward:
 - i) for doing or for bearing to do any action in relation to the Contract, or
 - ii) for showing or for bearing to show favor or disfavor to any person in relation to the Contract, or
 - iii) if any of the Contractor's Personnel, agents or Subcontractors gives or offers to give (directly or indirectly) to any person any such induce mentor reward as is described in this sub-paragraph (f). However, lawful inducements and rewards to Contractor's Personnel shall not entitle termination, or
- g) If the contract or repeatedly fails to remedy delivers defective work,
- h) based on reasonable evidence, has engaged in Fraud and Corruption as defined in paragraph 2.2 of the Appendix B to these General Conditions, incompetently for or in executing the Contract.

15.22 In any of these events or circumstances, the Procuring Entity may, upon giving 14 days' notice to the Contractor, terminate the Contract and expel the Contractor from the Site. However, in the case of sub-paragraph (e) or (f) or (g) or (h), the Procuring Entity may by notice terminate the Contract immediately.

15.23 The Procuring Entity's election to terminate the Contract shall not prejudice any other rights of the Procuring Entity, under the Contract otherwise.

15.24 The Contractor shall then leave the Site and deliver any required Goods, all Contractor's Documents, and other design documents made by or for him, to the Engineer. However, the Contractor shall use his best efforts to comply immediately with any reasonable instructions included in the notice (i) for the assignment of any subcontract, and (ii) for the protection of life or property or for the safety of the Works.

15.25 After termination, the Procuring Entity may complete the Works and/ or arrange for any other entities to do so. The Procuring Entity and these entities may then use any Goods, Contractor's Documents and other design documents made by or on behalf of the Contractor.

15.26 The Procuring Entity shall then give notice that the Contractor's Equipment and Temporary Works will be released to the Contractor at or near the Site. The Contractor shall promptly arrange their removal, at the risk and cost of the Contractor. However, if by this time the Contractor has failed to make a payment due to the Procuring Entity, these items may be sold by the Procuring Entity in order to recover this payment. Any balance of the proceeds shall then be paid to the Contractor.

15.3 Valuation at Date of Termination

As soon as practicable after a notice of termination under Sub-Clause 15.2 [Termination by Procuring Entity] has taken effect, the Architect shall proceed in accordance with Sub-Clause 3.5 [Determinations] to agree or determine the value of the Works, Goods and Contractor's Documents, and any other sums due to the Contractor for work executed in accordance with the Contract.

15.4 Payment after Termination

After a notice of termination under Sub-Clause 15.2 [Termination by Procuring Entity] has taken effect, the Procuring Entity may:

- a) Proceed in accordance with Sub-Clause 2.5 [Procuring Entity's Claims],
- b) withhold further payments to the Contractor until the costs of execution, completion and remedying of any defects, damages for delay in completion (if any), and all other costs incurred by the Procuring Entity, have been established, and/ or

- c) recover from the Contractor any losses and damages incurred by the Procuring Entity and any extra costs of completing the Works, after allowing for any sum due to the Contractor under Sub-Clause 15.3 [Valuation at Date of Termination]. After recovering any such losses, damages and extra costs, the Procuring Entity shall pay any balance to the Contractor.

155 Procuring Entity's Entitlement to Termination for Convenience

The Procuring Entity shall be entitled to terminate the Contract, at any time at the Procuring Entity's convenience, by giving notice of such termination to the Contractor. The termination shall take effect 30 days after the later of the dates on which the Contractor receives this notice or the Procuring Entity returns the Performance Security. The Procuring Entity shall not terminate the Contract under this Sub-Clause in order to execute the Works itself or to arrange for the Works to be executed by another contractor or to avoid a termination of the Contract by the Contractor under Clause 16.2 [Termination by Contractor]. After this termination, the Contractor shall proceed in accordance with Sub-Clause 16.3 [Cessation of Work and Removal of Contractor's Equipment] and shall be paid in accordance with Sub-Clause 16.4 [Payment on Termination].

156 Fraud and Corruption

The Contractor shall ensure compliance with the Kenya Government's Anti-Corruption Laws and its prevailing sanctions.

157 Corrupt gifts and payments of commission

15.7.1 The Contractor shall not;

- a) Offer or give or agree to give to any person in the service of the Procuring Entity any gift or consideration of any kind as an inducement or reward for doing or for bearing to door for having done or for borne to do any act in relation to the obtaining or execution of this or any other Contract for the Procuring Entity or for showing or for bearing to show favor or disfavor to any person in relation to this or any other contract for the Procuring Entity.
- b) Enter into this or any other contract with the Procuring Entity in connection with which commission has been paid or agreed to be paid by him or on his behalf or to his knowledge, unless before the Contract is made particulars of any such commission and of the terms and conditions of any agreement for the payment there of have been disclosed in writing to the Procuring Entity.

15.7.2 Any breach of this Condition by the Contractor or by anyone employed by him or acting on his behalf (whether with or without the knowledge of the Contractor) shall be an offence under the provisions of the Public Procurement and Asset Disposal Act (2015) and the Anti-Corruption and Economic Crimes Act (2003) of the Laws of Kenya.

16 SUSPENSION AND TERMINATION BY CONTRACTOR

16.1 Contractor's Entitlement to Suspend Work

16.1.1 If the Architect fails to certify in accordance with Sub-Clause 14.6 [Issue of Interim Payment Certificates] or Sub-Clause 14.7 [Payment], or not receiving instructions that would enable the contractor to proceed with the works in accordance with the program, the Contractor may, after giving not less than 30 days' notice to the Procuring Entity, suspend work (or reduce the rate of work) unless and until the Contractor has received the Payment Certificate, reasonable evidence or payment, as the case may be and as described in the notice.

16.1.2 The Contractor's action shall not prejudice his entitlements to financing charges under Sub-Clause 14.8 [Delayed Payment] and to termination under Sub-Clause 16.2 [Termination by Contractor].

16.1.3 If the Contractor subsequently receives such Payment Certificate, evidence or payment (as described in the relevant Sub-Clause and in the above notice) before giving a notice of termination, the Contractor shall resume normal working as soon as is reasonably practicable.

16.1.4 If the Contractor suffers delay and/or incurs Cost as a result of suspending work (or reducing the rate of work) in accordance with this Sub-Clause, the Contractor shall give notice to the Architect and shall be entitled subject to Sub-Clause 20.1 [Contractor's Claims] to:

- a) an extension of time for any such delay, if completion is or will be delayed, under Sub-Clause 8.4 [Extension of Time for Completion], and
- b) payment of any such Cost-plus profit, which shall be included in the Contract Price.

162 After receiving this notice, the Architect shall proceed in accordance with Sub-Clause 3.5 [Determinations] to agree or determine these matters.

163 Termination by Contractor

163.1 The Contractor shall be entitled to terminate the Contract if:

- a) the Architect fails, within 60 days after receiving a Statement and supporting documents, to issue the relevant Payment Certificate,
- b) the Contractor does not receive the amount due under an Interim Payment Certificate within 90 days after the expiry of the time stated in Sub-Clause 4.7 [Payment] within which payment is to be made (except for deductions in accordance with Sub-Clause 2.5 [Procuring Entity's Claims]),
- c) the Procuring Entity substantially fails to perform his obligations under the Contract in such manner as to materially and adversely affect the economic balance of the Contract and/or the ability of the Contractor to perform the Contract,
- d) a prolonged suspension affects the whole of the Works as described in Sub-Clause 8.11 [Prolonged Suspension], or
- e) the Procuring Entity becomes bankrupt or insolvent, goes into liquidation, has a receiving or administration order made against him, compounds with his creditors, or carries on business under a receiver, trustee or manager for the benefit of his creditors, or if any act is done or event occurs which (under applicable Laws) has a similar effect to any of these acts or events.
- f) the Contractor does not receive the Architect instruction recording the agreement of both Parties on the fulfilment of the conditions for the Commencement of Works under Sub-Clause 8.1 [Commencement of Works].

163.2 In any of these events or circumstances, the Contractor may, upon giving 14 days' notice to the Procuring Entity, terminate the Contract. However, in the case of sub-paragraph (f) or (g), the Contractor may by notice terminate the Contract immediately.

163.3 The Contractor's election to terminate the Contract shall not prejudice any other rights of the Contractor, under the Contract otherwise.

164 Cessation of Work and Removal of Contractor's Equipment

After a notice of termination under Sub-Clause 15.5 [Procuring Entity's Entitlement to Termination for Convenience], Sub-Clause 16.2 [Termination by Contractor] or Sub-Clause 19.6 [Optional Termination, Payment and Release] has taken effect, the Contractor shall promptly:

- a) cease all further work, except for such work as may have been instructed by the Architect for the protection of life or property or for the safety of the Works,
- b) hand over Contractor's Documents, Plant, Materials and other work, for which the Contractor has received payment, and
- c) remove all other Goods from the Site, except as necessary for safety, and leave the Site.

165 Payment on Termination

After a notice of termination under Sub-Clause 16.2 [Termination by Contractor] has taken effect, the Procuring Entity shall promptly:

- a) Return the Performance Security to the Contractor,
- b) pay the Contractor in accordance with Sub-Clause 19.6 [Optional Termination, Payment and Release], and
- c) pay to the Contractor the amount of any loss or damage sustained by the Contractor as a result of this termination.

17. RISK AND RESPONSIBILITY

17.1 Indemnities

- 17.1.1 The Contractor shall indemnify and hold harmless the Procuring Entity, the Procuring Entity's Personnel, and their respective agents, against and from all claims, damages, losses and expenses (including legal fees and expenses) in respect of:
- a) Bodily injury, sickness, disease or death, of any person whatsoever arising out of or in the course of or by reason of the Contractor's design (if any), the execution and completion of the Works and the remedying of any defects, unless attributable to any negligence, willful act or breach of the Contract by the Procuring Entity, the Procuring Entity's Personnel, or any of their respective agents, and
 - b) damage to or loss of any property, real or personal (other than the Works), to the extent that such damage or loss arises out of or in the course of or by reason of the Contractor's design (if any), the execution and completion of the Works and the remedying of any defects, unless and to the extent that any such damage or loss is attributable to any negligence, willful act or breach of the Contract by the Procuring Entity, the Procuring Entity's Personnel, their respective agents, or anyone directly or indirectly employed by any of them.
- 17.1.2 The Procuring Entity shall indemnify and hold harmless the Contractor, the Contractor's Personnel, and their respective agents, against and from all claims, damages, losses and expenses (including legal fees and expenses) in respect of (1) bodily injury, sickness, disease or death, which is attributable to any negligence, willful act or breach of the Contract by the Procuring Entity, the Procuring Entity's Personnel, or any of their respective agents, and (2) the matters for which liability may be excluded from insurance cover, as described in sub-paragraphs (d)(i), (ii) and (iii) of Sub-Clause 18.3 [Insurance Against Injury to Persons and Damage to Property], unless and to the extent that any such damage or loss is attributable to any negligence, willful act or breach of the Contract by the contractor, the contractor's Personnel, their respective agents, or anyone directly or indirectly employed by any of them.

17.2 Contractor's Care of the Works

- 17.2.1 The Contractor shall take full responsibility for the care of the Works and Goods from the Commencement Date until the Taking-Over Certificate is issued (or is deemed to be issued under Sub-Clause 10.1 [Taking Over of the Works and Sections]) for the Works, when responsibility for the care of the Works shall pass to the Procuring Entity. If a Taking-Over Certificate is issued (or is so deemed to be issued) for any Section or part of the Works, responsibility for the care of the Section or part shall then pass to the Procuring Entity.
- 17.2.2 After responsibility has accordingly passed to the Procuring Entity, the Contractor shall take responsibility for the care of any work which is outstanding on the date stated in a Taking-Over Certificate, until this outstanding work has been completed.
- 17.2.3 If any loss or damage happens to the Works, Goods or Contractor's Documents during the period when the Contractor is responsible for their care, from any cause not listed in Sub-Clause 17.3 [Procuring Entity's Risks], the Contractor shall rectify the loss or damage at the Contractor's risk and cost, so that the Works, Goods and Contractor's Documents conform with the Contract.
- 17.2.4 The Contractor shall be liable for any loss or damage caused by any actions performed by the Contractor after a Taking-Over Certificate has been issued. The Contractor shall also be liable for any loss or damage which occurs after a Taking-Over Certificate has been issued and which arose from a previous event for which the Contractor was liable.

17.3 Procuring Entity's Risks

The risks referred to in Sub-Clause 17.4 [Consequences of Procuring Entity's Risks] below, in so far as they directly affect the execution of the Works in Kenya, are:

- a) War hostilities (whether war be declared or not),
- b) rebellion, riot, commotion or disorder, terrorism, sabotage by persons other than the Contractor's Personnel,
- c) explosive materials, ionizing radiation or contamination by radio-activity, except as may be attributable to the Contractor's use of such explosives, radiation or radio-activity,
- d) pressure waves caused by aircraft or other aerial devices traveling at sonic or supersonic speeds,

- e) use or occupation by the Procuring Entity of any part of the Permanent Works, except as may be specified in the Contract,
- f) design of any part of the Works by the Procuring Entity's Personnel or by others for whom the Procuring Entity is responsible, and
- g) any operation of the forces of nature which is Unforeseeable or against which an experienced contractor could not reasonably have been expected to have taken adequate preventive precautions.

174 Consequences of Procuring Entity's Risks

- 174.1 If and to the extent that any of the risks listed in Sub-Clause 17.3 above results in loss or damage to the Works, Goods or Contractor's Documents, the Contractor shall promptly give notice to the Architect and shall rectify this loss or damage to the extent required by the Engineer.
- 174.2 If the Contractor suffers delay and/ or incurs Cost from rectifying this loss or damage, the Contractor shall give a further notice to the Architect and shall be entitled subject to Sub-Clause 20.1 [Contractor's Claims] to:
- (a) An extension of time for any such delay, if completion is or will be delayed, under Sub-Clause 8.4 [Extension of TimeforCompletion], and
 - (b) Payment of any such Cost, which shall be included in the Contract Price. In the case of sub-paragraphs (e)and (g) of Sub-Clause 17.3 [Procuring Entity's Risks], Accrued Costs shall be payable.
- 174.3 After receiving this further notice, the Architect shall proceed in accordance with Sub-Clause 3.5 [Determinations] to agree or determine these matters.

175 Intellectual and Industrial Property Rights

- 175.1 In this Sub-Clause, “infringement” shall refer to an infringement (or alleged infringement) of any patent, registered design, copyright, trade mark, trade name, trade secret or other intellectual or industrial property right relating to the Works; and “claim” shall refer to a claim (or proceedings pursuing a claim) alleging an infringement.
- 175.2 Whenever a Party does not give notice to the other Party of any claim within 30 days of receiving the claim, the first Party shall be deemed to have waived any right to indemnity under this Sub-Clause.
- 175.3 The Procuring Entity shall indemnify and hold the Contractor harmless against and from any claim alleging an infringement which is or was:
- a) An un avoidable result of the Contractor's compliance with the Contract, or
 - b) A result of any Works be ingused by the Procuring Entity:
 - i) for a purpose other than that indicated by, or reasonably to be inferred from, the Contract, or
 - ii) in conjunction with anything not supplied by the Contractor, unless such use was disclosed to the Contractor prior to the Base Date or is stated in the Contract.
- 175.4 The Contractor shall indemnify and hold the Procuring Entity harmless again stand from any other claim which arises out of or in relation to (i) the manufacture, use, sale or import of any Goods, or (ii) any design for which the Contractor is responsible.
- 175.5 IfaPartyisentitledtobeindemnified under this Sub-Clause, the indemnifying Party may (at its cost) conduct negotiations for the settlement of the claim, and any litigation or arbitration which may arise from it. The other Party shall, at the request and cost of the indemnifying Party, assist in contesting the claim. This other Party (and its Personnel) shall not make any admission which might be prejudicial to the indemnifying Party, unless the indemnifying Party failed to take over the conduct of any negotiations, litigation or arbitration upon being requested to do so by such other Party.
- 175.6 For operation and maintenance of any plan to reequipment installed, the contractor shall grant a non-exclusive and non-transferable license to the Procuring Entity under the patent, utility models ,or other intellectual rights owned by the contractor or a third party from whom the contract or has received the rights to grant sub-licenses and shall also grant to the Procuring Entity a non-exclusive and non-transferable rights (without the rights to sub-license) to use the know how and other technical information disclosed to the contract or under the contract. Nothing contained here-in shall be construed as transferring ownership of any patent, utility model, trademark, design, copy right, know-how or other intellectual rights from the contractor or any other third party to the Procuring Entity.

17.6 Limitation of Liability

- 17.6.1 Neither Party shall be liable to the other Party for loss of use of any Works, loss of profit, loss of any contractor for any consequential loss or damage which may be suffered by the other Party in connection with the Contract, other than as specifically provided in Sub-Clause 8.7 [Delay Damages]; Sub-Clause 11.2 [Cost of Remedying Defects]; Sub-Clause 15.4 [Payment after Termination]; Sub-Clause 16.4 [Payment on Termination]; Sub-Clause 17.1 [Indemnities]; Sub-Clause 17.4(b) [Consequences of Procuring Entity's Risks] and Sub-Clause 17.5 [Intellectual and Industrial Property Rights].
- 17.6.2 The total liability of the Contractor to the Procuring Entity, under or in connection with the Contract other than under Sub-Clause 4.19 [Electricity, Water and Gas], Sub-Clause 4.20 [Procuring Entity's Equipment and Free-Issue Materials], Sub-Clause 17.1 [Indemnities] and Sub-Clause 17.5 [Intellectual and Industrial Property Rights], shall not exceed the sum resulting from the application of a multiplier (less or greater than one) to the Accepted Contract Amount, as stated in **the Special Conditions of Contract**, or (if such multiplier or other sum is not so stated) the Accepted Contract Amount.
- 17.6.3 This Sub-Clause shall not limit liability in any case of fraud, deliberate default or reckless misconduct by the defaulting Party.

17.7 Use of Procuring Entity's Accommodation/Facilities

- 17.7.1 The Contractor shall take full responsibility for the care of the Procuring Entity provided accommodation and facilities, if any, as detailed in the Specification, from the respective dates of hand-over to the Contractor until cessation of occupation (where hand-over or cessation of occupation may take place after the date stated in the Taking-Over Certificate for the Works).
- 17.7.2 If any loss or damage happens to any of the above items while the Contractor is responsible for their care arising from any cause whatsoever other than those for which the Procuring Entity is liable, the Contractor shall, at his own cost, rectify the loss or damage to the satisfaction of the Engineer.

18 INSURANCE

18.1 General Requirements for Insurances

- 18.1.1 In this Clause, "insuring Party" means, for each type of insurance, the Party responsible for effecting and maintaining the insurance specified in the relevant Sub-Clause.
- 18.1.2 Wherever the Contractor is the insuring Party, each insurance shall be effected with insurers and in terms approved by the Procuring Entity. These terms shall be consistent with any terms agreed by both Parties before the date of the Letter of Acceptance. This agreement of terms shall take precedence over the provisions of this Clause.
- 18.1.3 Wherever the Procuring Entity is the insuring Party, each insurance shall be effected with insurers and in terms acceptable to the Contractor. These terms shall be consistent with any terms agreed by both Parties before the date of the Letter of Acceptance. This agreement of terms shall take precedence over the provisions of this Clause.
- 18.1.4 If a policy is required to indemnify joint insured, the cover shall apply separately to each insured as though a separate policy had been issued for each of the joint insured. If a policy indemnifies additional joint insured, namely in addition to the insured specified in this Clause, (i) the Contractor shall act under the policy on behalf of these additional joint insured except that the Procuring Entity shall act for Procuring Entity's Personnel, (ii) additional joint insured shall not be entitled to receive payments directly from the insurer or to have any other direct dealings with the insurer, and (iii) the insuring Party shall require all additional joint insured to comply with the conditions stipulated in the policy.
- 18.1.5 Each policy insuring against loss or damage shall provide for payments to be made in the currencies required to rectify the loss or damage. Payments received from insurers shall be used for the rectification of the loss or damage.

- 18.1.6 The relevant insuring Party shall, within the respective periods stated in **the Special Conditions of Contract** (calculated from the Commencement Date), submit to the other Party:
- a) Evidence that the insurances described in this Clause have been affected, and
 - b) copies of the policies for the insurances described in Sub-Clause 18.2 [Insurance for Works and Contractor's Equipment] and Sub-Clause 18.3 [Insurance against Injury to Persons and Damage to Property].
- 18.1.7 When each premium is paid, the insuring Party shall submit evidence of payment to the other Party. Whenever evidence or policies are submitted, the insuring Party shall also give notice to the Engineer.
- 18.1.8 Each Party shall comply with the conditions stipulated in each of the insurance policies. The insuring Party shall keep the insurers informed of any relevant changes to the execution of the Works and ensure that insurance is maintained in accordance with this Clause.
- 18.1.9 Neither Party shall make any material alteration to the terms of any insurance without the prior approval of the other Party. If an insurer makes (or attempts to make) any alteration, the Party first notified by the insurer shall promptly give notice to the other Party.
- 18.1.10 If the insuring Party fails to effect and keep in force any of the insurances it is required to effect and maintain under the Contract fails to provide satisfactory evidence and copies of policies in accordance with this Sub-Clause, the other Party may (at its option and without prejudice to any other right or remedy) effect insurance for the relevant coverage and pay the premiums due. The insuring Party shall pay the amount of these premiums to the other Party, and the Contract Price shall be adjusted accordingly.
- 18.1.11 Nothing in this Clause limits the obligations, liabilities or responsibilities of the Contractor or the Procuring Entity, under the other terms of the Contract otherwise. Any amounts not insured or not recovered from the insurers shall be borne by the Contractor and/or the Procuring Entity.
- 18.1.12 Procuring Entity in accordance with these obligations, liabilities or responsibilities. However, if the insuring Party fails to effect and keep in force an insurance which is available and which it is required to effect and maintain under the Contract, and the other Party neither approves the omission nor effects insurance for the coverage relevant to this default, any moneys which should have been recoverable under this insurance shall be paid by the insuring Party.
- 18.1.13 Payments by one Party to the other Party shall be subject to Sub-Clause 2.5 [Procuring Entity's Claims] or Sub-Clause 20.1 [Contractor's Claims], as applicable.
- 18.1.14 The Contractor shall be entitled to place all insurance relating to the Contract (including, but not limited to the insurance referred to Clause 18) with insurers from any eligible source country.

18.2 Insurance for Works and Contractor's Equipment

- 18.2.1 The insuring Party shall insure the Works, Plant, Material and Contractor's Documents for not less than the full reinstatement cost including the costs of demolition, removal of debris and professional fees and profit. This insurance shall be effective from the date by which the evidence is to be submitted under sub-paragraph (a) of Sub-Clause 18.1 [General Requirements for Insurances], until the date of issue of the Taking-Over Certificate for the Works.
- 18.2.2 The insuring Party shall maintain this insurance to provide cover until the date of issue of the Performance Certificate, for loss or damage for which the Contractor is liable arising from a cause occurring prior to the issue of the Taking-Over Certificate, and for loss or damage caused by the Contractor in the course of any other operations (including those under Clause 11 [Defects Liability]).
- 18.2.3 The insuring Party shall insure the Contractor's Equipment for not less than the full replacement value, including delivery to Site. For each item of Contractor's Equipment, the insurance shall be effective while it is being transported to the Site and until it is no longer required as Contractor's Equipment.
- 18.2.4 Unless otherwise stated in the Special Conditions, insurances under this Sub-Clause:
- a) Shall be effected and maintained by the Contractor as insuring Party,

- b) shall be in the joint names of the Parties, who shall be jointly entitled to receive payments from the insurers, payments being held or allocated to the Party actually bearing the costs of rectifying the loss or damage,
- c) shall cover all loss and damage from any cause not listed in Sub-Clause 17.3 [Procuring Entity's Risks],
- d) shall also cover, to the extent specifically required in the tendering documents of the Contract, loss or damage to a part of the Works which is attributable to the use or occupation by the Procuring Entity of another part of the Works, and loss or damage from the risks listed in sub-paragraphs (c), (g) and (h) of Sub-Clause 17.3 [Procuring Entity's Risks], excluding (in each case) risks which are not insurable at commercially reasonable terms, with deductibles per occurrence of not more than the amount stated **in the Special Conditions** of Contract (if an amount is not so stated, this sub-paragraph (d) shall not apply), and
- e) may however exclude loss of, damage to, and reinstatement of:
 - i) a part of the Works which is in a defective condition due to a defect in its design, materials or workmanship (but cover shall include any other parts which are lost or damaged as a direct result of this defective condition and not as described in sub-paragraph (ii) below),
 - ii) a part of the Works which is lost or damaged in order to reinstate any other part of the Works if this other part is in a defective condition due to a defect in its design, materials or workmanship,
 - iii) a part of the Works which has been taken over by the Procuring Entity, except to the extent that the Contractor is liable for the loss or damage, and
 - iv) Goods while they are not in Kenya, subject to Sub-Clause 14.5 [Plant and Materials intended for the Works].

18.25 If, more than one year after the Base Date, the cover described in sub-paragraph (d) above ceases to be available at commercially reasonable terms, the Contractor shall (as insuring Party) give notice to the Procuring Entity, with supporting particulars. The Procuring Entity shall then (i) be entitled subject to Sub-Clause 2.5 [Procuring Entity's Claims] to payment of an amount equivalent to such commercially reasonable terms as the Contractor should have expected to have paid for such cover, and (ii) be deemed, unless he obtains the cover at commercially reasonable terms, to have approved the omission under Sub-Clause 18.1 [General Requirements for Insurances].

18.3 Insurance against Injury to Persons and Damage to Property

18.3.1 The insuring Party shall insure against each Party's liability for any loss, damage, death or bodily injury which may occur to any physical property (except things insured under Sub-Clause 18.2 [Insurance for Works and Contractor's Equipment]) or to any person (except persons insured under Sub-Clause 18.4 [Insurance for Contractor's Personnel]), which may arise out of the Contractor's performance of the Contract and occurring before the issue of the Performance Certificate.

18.3.2 This insurance shall be for a limit per occurrence of not less than the amount stated in **the Special Conditions of Contract**, with no limit on the number of occurrences. If an amount is not stated in the **Special Conditions of Contract**, this Sub-Clause shall not apply.

18.3.3 Unless otherwise stated in the Special Conditions, the insurances specified in this Sub-Clause:

- a) Shall be effected and maintained by the Contractor as insuring Party,
- b) shall be in the joint names of the Parties,
- c) shall be extended to cover liability for all loss and damage to the Procuring Entity's property (except things insured under Sub-Clause 18.2) arising out of the Contractor's performance of the Contract, and
- d) may however exclude liability to the extent that it arises from:
 - i) the Procuring Entity's right to have the Permanent Works executed on, over, under, in or
 - ii) through any land, and to occupy this land for the Permanent Works,
 - iii) damage which is an unavoidable result of the Contractor's obligations to execute the
 - iv) Works and remedy any defects, and
 - v) a cause listed in Sub-Clause 17.3 [Procuring Entity's Risks], except to the extent that cover is available at commercially reasonable terms.

184 Insurance for Contractor's Personnel

- 184.1 The Contractor shall effect and maintain insurance against liability for claims, damages, losses and expenses (including legal fees and expenses) arising from injury, sickness, disease or death of any person employed by the Contractor or any other of the Contractor's Personnel.
- 184.2 The insurance shall cover the Procuring Entity and the Architect against liability for claims, damages, losses and expenses (including legal fees and expenses) arising from injury, sickness, disease or death of any person employed by the Contractor or any other of the Contractor's Personnel, except that this insurance may exclude losses and claims to the extent that they arise from any act or neglect of the Procuring Entity or of the Procuring Entity's Personnel.
- 184.3 The insurance shall be maintained in full force and effect during the whole time that these personnel are assisting in the execution of the Works. For a Subcontractor's employees, the insurance may be effected by the Subcontractor, but the Contractor shall be responsible for compliance with this Clause.

19. FORCE MAJEURE

19.1 Definition of Force Majeure

- 19.1.1 In this Clause, "Force Majeure" means an exceptional event or circumstance:
- a) Which is beyond a Party's control,
 - b) Which such Party could not reasonably have provided against before entering into the Contract,
 - c) which, having arisen, such Party could not reasonably have avoided or overcome, and
 - d) which is not substantially attributable to the other Party.
- 19.1.2 Force Majeure may include, but is not limited to, exceptional events or circumstances of the kind listed below, so long as conditions (a) to (d) above are satisfied:
- a) war, hostilities (whether war be declared or not), invasion, act of foreign enemies,
 - b) rebellion, terrorism, sabotage by persons other than the Contractor's Personnel, revolution, insurrection, military or usurped power, or civil war,
 - c) riot, commotion, disorder, strike or lock out by persons other than the Contractor's Personnel,
 - d) munitions of war, explosive materials, ionizing radiation or contamination by radio-activity, except as may be attributable to the Contractor's use of such munitions, explosives, radiation or radio-activity, and
 - e) natural catastrophes such as earthquake, hurricane, typhoon or volcanic activity.

19.2 Notice of Force Majeure

- 19.2.1 If a Party is or will be prevented from performing its substantial obligations under the Contract by Force Majeure, then it shall give notice to the other Party of the event or circumstances constituting the Force Majeure and shall specify the obligations, the performance of which is or will be prevented. The notice shall be given within 14 days after the Party became aware, or should have become aware, of the relevant event or circumstance constituting Force Majeure.
- 19.2.2 The Party shall, having given notice, be excused performance of its obligations for so long as such Force Majeure prevents it from performing them.
- 19.2.3 Notwithstanding any other provision of this Clause, Force Majeure shall not apply to obligations of either Party to make payments to the other Party under the Contract.

19.3 Duty to Minimize Delay

Each Party shall at all times use all reasonable endeavors to minimize any delay in the performance of the Contract as a result of Force Majeure. A Party shall give notice to the other Party when it ceases to be affected by the Force Majeure.

19.4 Consequences of Force Majeure

- 19.4.1 If the Contractor is prevented from performing his substantial obligations under the Contract by Force Majeure of which notice has been given under Sub-Clause 19.2 [Notice of Force Majeure], and suffers delay and/ or incurs Cost by reason of such Force Majeure, the Contractor shall be entitled subject to Sub-Clause 20.1 [Contractor's Claims] to:

- a) an extension of time for any such delay, if completion is or will be delayed, under Sub-Clause 8.4 [Extension of Time for Completion], and
- b) if the event or circumstance is of the kind described in sub-paragraphs (i) to (iv) of Sub-Clause 19.1 [Definition of Force Majeure] and, in sub-paragraphs (ii) to (iv), occurs in Kenya, payment of any such Cost, including the costs of rectifying or replacing the Works and/or Goods damaged or destroyed by Force Majeure, to the extent they are not indemnified through the insurance policy referred to in Sub-Clause 18.2 [Insurance for Works and Contractor's Equipment].

19.4.2 After receiving this notice, the Architect shall proceed in accordance with Sub-Clause 3.5 [Determinations] to agree or determine these matters.

19.5 Force Majeure Affecting Subcontractor

If any Subcontractor is entitled under any contract or agreement relating to the Works to relief from force majeure on terms additional to or broader than those specified in this Clause, such additional or broader force majeure events or circumstances shall not excuse the Contractor's non-performance or entitle him to relief under this Clause.

19.6 Optional Termination, Payment and Release

19.6.1 If the execution of substantially all the Works in progress is prevented for a continuous period of 84 days by reason of Force Majeure of which notice has been given under Sub-Clause 19.2 [Notice of Force Majeure], or for multiple periods which total more than 140 days due to the same notified Force Majeure, then either Party may give to the other Party a notice of termination of the Contract. In this event, the termination shall take effect 7 days after the notice is given, and the Contractor shall proceed in accordance with Sub-Clause 16.3 [Cessation of Work and Removal of Contractor's Equipment].

19.6.2 Upon such termination, the Architect shall determine the value of the work done and issue a Payment Certificate which shall include:

- a) the amount payable for any work carried out for which a price is stated in the Contract;
- b) the Cost of Plant and Materials ordered for the Works which have been delivered to the Contractor, or of which the Contractor is liable to accept delivery: this Plant and Materials shall become the property of (and be at the risk of) the Procuring Entity when paid for by the Procuring Entity, and the Contractor shall place the same at the Procuring Entity's disposal;
- c) other Cost or liabilities which in the circumstances were reasonably and necessarily incurred by the Contractor in the expectation of completing the Works;
- d) the Cost of removal of Temporary Works and Contractor's Equipment from the Site and the return of these items to the Contractor's works in his country (or to any other destination at no greater cost); and
- e) the Cost of repatriation of the Contractor's staff and lab or employed wholly in connection with the Works at the date of termination.

19.7 Release from Performance

Notwithstanding any other provision of this Clause, if any event or circumstance outside the control of the Parties (including, but not limited to, Force Majeure) arises which makes it impossible or unlawful for either or both Parties to fulfil its or their contractual obligations or which, under the law governing the Contract, entitles the Parties to be released from further performance of the Contract, then upon notice by either Party to the other Party of such event or circumstance:

- a) The Parties shall be discharged from further performance, without prejudice to the rights of either Party in respect of any previous breach of the Contract, and
- b) The sum payable by the Procuring Entity to the Contractor shall be the same as would have been payable under Sub-Clause 19.6 [Optional Termination, Payment and Release] if the Contract had been terminated under Sub-Clause 19.6.

20 SETTLEMENT OF CLAIMS AND DISPUTES

20.1 Contractor's Claims

- 20.1.1 If the Contractor considers itself to be entitled to any extension of the Time for Completion and/or any additional payment, under any Clause of these Conditions or otherwise in connection with the Contract, the Contractor shall give Notice to the Engineer, describing the event or circumstance giving rise to the claim. The notice shall be given as soon as practicable, and not later than 30 days after the Contractor became aware, or should have become aware, of the event or circumstance.
- 20.1.2 If the Contractor fails to give notice of a claim within such period of 30 days, the Time for Completion shall not be extended, the Contractor shall not be entitled to additional payment, and the Procuring Entity shall be discharged from all liability in connection with the claim. Otherwise, the following provisions of this Sub-Clause shall apply.
- 20.1.3 The Contractor shall also submit any other notices which are required by the Contract, and supporting particulars for the claim, all as relevant to such event or circumstance.
- 20.1.4 The Contractor shall keep such contemporary records as may be necessary to substantiate any claim, either on the Site or at an other location acceptable to the Engineer. Without admitting the Procuring Entity's liability, the Architect may, after receiving any notice under this Sub-Clause, monitor the record-keeping and/or instruct the Contractor to keep further contemporary records. The Contractor shall permit the Architect to inspect all these records and shall (if instructed) submit copies to the Engineer.
- 20.1.5 Within 42 days after the Contractor became aware (or should have become aware) of the event or circumstance giving rise to the claim, or within such other period as may be proposed by the Contractor and approved by the Engineer, the Contractor shall send to the Architect fully detailed claim which includes full supporting particulars of the basis of the claim and of the extension of time and/ or additional payment claimed. If the event or circumstance giving rise to the claim has a continuing effect:
- a) This fully detailed claim shall be considered as interim;
 - b) The Contractor shall send further interim claims at monthly intervals, giving the accumulated delay and/ or amount claimed, and such further particulars as the Architect may reasonably require; and
 - c) The Contractor shall send a final claim within 30 days after the end of the effects resulting from the event or circumstance, or within such other period as may be proposed by the Contractor and approved by the Engineer.
- 20.1.6 Within 42 days after receiving a Notice of a claim or any further particulars supporting a previous claim, or within such other period as may be proposed by the Architect and approved by the Contractor, the Architect shall respond with approval, or with disapproval and detailed comments. He may also request any necessary further particulars but shall nevertheless give his response on the principles of the claim within the above defined time period.
- 20.1.7 Within the above defined period of 42 days, the Architect shall proceed in accordance with Sub-Clause 3.5 [Determinations] to agree or determine (i) the extension (if any) of the Time for Completion (before or after its expiry) in accordance with Sub-Clause 8.4 [Extension of Time for Completion], and/or (ii) the additional payment (if any) to which the Contractor is entitled under the Contract.
- 20.1.8 Each Payment Certificate shall include such additional payment for any claim as has been reasonably substantiated as due under the relevant provision of the Contract. Unless and until the particulars supplied are sufficient to substantiate the whole of the claim, the Contractor shall only be entitled to payment for such part of the claim as he has been able to substantiate.
- 20.1.9 If the Architect does not respond within the time frame defined in this Clause, either Party may consider that the claim is rejected by the Architect and any of the Parties may refer the dispute for amicable settlement in accordance with Clause 20.3.
- 20.1.10 The requirements of this Sub-Clause are in addition to those of any other Sub-Clause which may apply to a claim. If the Contractor fails to comply with this or another Sub-Clause in relation to any claim, any extension of time and/ or additional payment shall take account of the extent (if any) to which the failure has prevented or prejudiced proper investigation of the claim, unless the claim is excluded under the second paragraph of this Sub-Clause 20.3.

202 Procuring Entity's Claims

- 202.1 If the Procuring Entity considers itself to be entitled to any payment under any Clause of these Conditions or otherwise in connection with the Contract, and/or to any extension of the Defects Notification Period, the Procuring Entity or the Architect shall give notice and particulars to the Contractor. However, notice is not required for payments due under Sub-Clause 4.19 [Electricity, Water and Gas], under Sub-Clause 4.20 [Procuring Entity's Equipment and Free-Issue Materials], or for other services requested by the Contractor.
- 202.2 The notice shall be given as soon as practicable and no longer than 30 days after the Procuring Entity became aware, or should have become aware, of the event or circumstances giving rise to the claim. A notice relating to any extension of the Defects Notification Period shall be given before the expiry of such period.
- 202.3 The particulars shall specify the Clause or other basis of the claim and shall include substantiation of the amount and/or extension to which the Procuring Entity considers itself to be entitled in connection with the Contract. The Architect shall then proceed in accordance with Sub-Clause 3.5 [Determinations] to agree or determine (i) the amount (if any) which the Procuring Entity is entitled to be paid by the Contractor, and/or (ii) the extension (if any) of the Defects Notification Period in accordance with Sub-Clause 11.3 [Extension of Defects Notification Period].
- 202.4 This amount may be included as a deduction in the Contract Price and Payment Certificates. The Procuring Entity shall only be entitled to set off against or make any deduction from an amount certified in a Payment Certificate, or to otherwise claim against the Contractor, in accordance with this Sub-Clause.

203 Amicable Settlement

Where a notice of a claim has been given, both Parties shall attempt to settle the dispute amicably before the commencement of arbitration. However, unless both Parties agree otherwise, the Party giving a notice of a claim in accordance with Sub-Clause 20.1 above should move to commence arbitration after 60 days from the day on which a notice of a claim was given, even if no attempt at an amicable settlement has been made.

204 Matters that may be referred to arbitration

Notwithstanding anything stated herein the following matters may be referred to arbitration before the practical completion of the Works or abandonment of the Works or termination of the Contract by either party:

- a) Whether or not the issue of an instruction by the Architect is empowered by these Conditions.
- b) Whether or not a certificate has been improperly withheld or is not in accordance with these Conditions.
- c) Any dispute arising in respect risks arising from matters referred to in Clause 17.3 and Clause 19.
- e) All other matters shall only be referred to arbitration after the completion or alleged completion of the Works or termination or alleged termination of the Contract, unless the Procuring Entity and the Contractor agree otherwise in writing.

205 Arbitration

- 205.1 Any claim or dispute between the Parties arising out of or in connection with the Contract not settled amicably in accordance with Sub-Clause 20.3 shall be finally settled by arbitration.
- 205.2 No arbitration proceedings shall be commenced on any claim or dispute where notice of a claim or dispute has not been given by the applying party within ninety days of the occurrence or discovery of the matter or issue giving rise to the dispute.
- 205.3 Notwithstanding the issue of a notice as stated above, the arbitration of such a claim or dispute shall not commence unless an attempt has in the first instance been made by the parties to settle such claim or dispute amicably with or without the assistance of third parties. Proof of such attempt shall be required.
- 205.4 The Arbitrator shall, without prejudice to the generality of his powers, have powers to direct such measurements, computations, tests or valuations as may in his opinion be desirable in order to determine the rights of the parties and assess and award any sums which ought to have been the subject of or included in any certificate.

- 2055 The Arbitrator shall, without prejudice to the generality of his powers, have powers to open up, review and revise any certificate, opinion, decision, requirement or notice and to determine all matters in dispute which shall be submitted to him in the same manner as if no such certificate, opinion, decision require mentor notice had been given.
- 2056 The arbitrators shall have full power to open up, review and revise any certificate, determination, instruction, opinion or valuation of the Engineer, relevant to the dispute. Nothing shall disqualify representatives of the Parties and the Architect from being called as a witness and giving evidence before the arbitrators on any matter whatsoever relevant to the dispute.
- 2057 Neither Party shall be limited in the proceedings before the arbitrators to the evidence, or to the reasons for dissatisfaction given in its Notice of Dissatisfaction.
- 2057 Arbitration may be commenced prior to or after completion of the Works. The obligations of the Parties, and the Architect shall not be altered by reason of any arbitration being conducted during the progress of the Works.
- 2058 The terms of the remuneration of each or all the members of Arbitration shall be mutually agreed upon by the Parties when agreeing the terms of appointment. Each Party shall be responsible for paying one-half of this remuneration.

20.6 Arbitration with National Contractors

- 2061 If the Contract is with national contractors, arbitration proceedings will be conducted in accordance with the Arbitration Laws of Kenya. In case of any claim or dispute, such claim or dispute shall be notified in writing by either party to the other with a request to submit it to arbitration and to concur in the appointment of an Arbitrator within thirty days of the notice. The dispute shall be referred to the arbitration and final decision of a person to be agreed between the parties. Failing agreement to concur in the appointment of an Arbitrator, the Arbitrator shall be appointed, on the request of the applying party, by the Chairman or Vice Chairman of any of the following professional institutions;
- i) Architectural Association of Kenya
 - ii) Institute of Quantity Surveyors of Kenya
 - iii) Association of Consulting Engineers of Kenya
 - iv) Chartered Institute of Arbitrators (Kenya Branch)
 - v) Institution of Engineers of Kenya
- 2062 The institution written to first by the aggrieved party shall take precedence over all other institutions.

20.7 Arbitration with Foreign Contractors

- 2071 Arbitration with foreign contractors shall be conducted in accordance with the arbitration rules of the United Nations Commission on International Trade Law (UNCITRAL); or with proceedings administered by the International Chamber of Commerce (ICC) and conducted under the ICC Rules of Arbitration; by one or more arbitrators appointed in accordance with said arbitration rules.
- 2072 The place of arbitration shall be a location specified in the **SCC**; and the arbitration shall be conducted in the language for communications defined in Sub-Clause 1.4 [Law and Language].

20.8 Alternative Arbitration Proceedings

Alternatively, the Parties may refer the matter to the Nairobi Centre for International Arbitration (NCIA) which offers a neutral venue for the conduct of national and international arbitration with commitment to providing institutional support to the arbitral process.

20.9 Failure to Comply with Arbitrator's Decision

- 2091 The award of such Arbitrator shall be final and binding upon the parties.
- 2092 In the event that a Party fails to comply with a final and binding Arbitrator's decision, then the other Party may, without prejudice to any other rights it may have, refer the matter to a competent court of law.

20.10 Contract operations to continue

Notwithstanding any reference to arbitration herein,

- 1.1.1 the parties shall continue to perform their respective obligations under the Contract unless they otherwise agree; and
- 1.1.2 the Procuring Entity shall pay the Contractor any monies due the Contractor.

SECTION IX - SPECIAL CONDITIONS OF CONTRACT

The following Special Conditions shall supplement the GCC. Whenever there is a conflict, the provisions here in shall prevail over those in the GCC.

Part A - Contract Data

Conditions	Sub Clause	Data
Procuring Entity's name and address	1.1	KARUMO TECHNICAL TRAINING INSTITUTE
Name and Reference No. of the Contract	1.1	as indicated in the tender advertisement_
Consultant Name and Address	1.1 and 3.1.1	Regional Works Officer – Eastern Region P.O.Box 455-60100 Embu
Time for completion	1.1	To be agreed with the Project Manager
Section	1.1	Not applicable
Defects Liability period	1.1	26 weeks
Electronic transmission systems	1.3	N/A
Time for parties to enter into a contract agreement	1.6	Within 30 Days
Time for access to the site	2.1.1	To be agreed with the Project Manager
Architect Duties and Responsibilities	3.1.6 (b) (ii)	Variations that exceed the accepted contract Amount shall require approval from the procurement entity
Performance Security	4.2.1	The performance security will be in the form of a performance bond in the amount of 5% of the accepted Amount in the same currency(ies) of the accepted contract amount
Contractor's Representative Name	4.3.1	To be agreed with the Project Manager
Normal Working Hours	6.5	To be agreed with the Project Manager
Commencement date	8.1.1	To be agreed with the Project Manager
Delay damages for the Works	8.7.1 & 14.15 (b)	0.01 % of the Contract price per day
Maximum amount for Delay Damages	8.7.1	5% of the final contract price

Conditions	Sub Clause	Data
Provisional Sums	13.6. (b)(ii)	As determined by the Project Manager
Adjustments for Changes in Cost	13.9	Not applicable
Total advance payment	14.2.1	Not applicable
Repayment amortization rate of advance payment	14.2.5 (b)	Not applicable
Percentage of Retention	14.3.2 (c)	10%
Limit of Retention Money	14.3.2 (c)	<u>10</u> % of the Accepted Contract Amount
Plant and Materials	14.5.3(b)(i)	If Sub-Clause 14.5 applies: Plant and Materials for payment Free on Board _____ [<i>Not Applicable</i>].
	14.5.3(c)(i)	Plant and Materials for payment when delivered to the Site : <i>Plant and materials to be incorporated into permanent works</i>
Minimum Amount of Interim Payment Certificates	14.6	Not applicable
Publishing source of commercial interest rates for financial charges in case of delayed payment	14.8	Central Bank of Kenya
Key Personnel names	6.9.1	To be agreed with the Project Manager
Maximum total liability of the Contractor to the Procuring Entity	17.6.2	As per applicable laws
Periods for submission of insurance: a. evidence of insurance. b. Relevant policies	18.1.6	14 days <u>14</u> days
Maximum amount of deductibles for insurance of the Procuring Entity's risks	18.2.4 (d)	<i>As per applicable laws</i>
Minimum amount of third-party insurance	18.3.2	<i>As per applicable laws</i>
The place of arbitration	20.7.2	<i>Meru County, Kenya</i>

SECTION X - CONTRACT FORMS

FORM No. 1 - NOTIFICATION OF INTENTION TO AWARD

FORM No. 2 - NOTIFICATION OF AWARD - LETTER OF ACCEPTANCE

FORM No. 3 - CONTRACT AGREEMENT

FORM No. 4 - PERFORMANCE SECURITY [Option 1 - Unconditional Demand Bank Guarantee]

FORM No. 5- PERFORMANCE SECURITY [Option 2- Performance Bond]

FORM No. 6 - ADVANCE PAYMENT SECURITY

FORM No. 7 - RETENTION MONEY SECURITY

FORM No 1: NOTIFICATION OF INTENTION TO AWARD OF CONTRACT

This Notification of Award shall be sent to each Tenderer that submitted a Tender and was not successful. Send this Notification to the Tenderer's Authorized Representative named in the Tender Information Form on the format below.

FORMAT

1. For the attention of Tenderer's Authorized Representative

- i) Name: *[insert Authorized Representative's name]*
- ii) Address: *[insert Authorized Representative's Address]*
- iii) Telephone: *[insert Authorized Representative's telephone/fax numbers]*
- iv) Email Address: *[insert Authorized Representative's email address]*

[IMPORTANT: insert the date that this Notification is transmitted to Tenderers. The Notification must be sent to all Tenderers simultaneously. This means on the same date and as close to the same time as possible.]

2. Date of transmission: *[email]* on *[date]* (local time)

This Notification is sent by *(Name and designation)* _____

3. Notification of Award

- i) Procuring Entity: *[insert the name of the ProcuringEntity]*
- ii) Project: *[insert name ofproject]*
- iii) Contract title: *[insert the name of thecontract]*
- iv) ITT No: *[insert ITT reference number from ProcurementPlan]*

This Notification of Intention to Award (Notification) notifies you of our decision to award the above contract. The transmission of this Notification begins the Standstill Period. During the Standstill Period, you may:

4. Request a debriefing in relation to the evaluation of your tender by submitting a Procurement-related Complaint in relation to the decision to award the contracts.

a) The successful tenderers

i) Name of successful Tender _____

ii) Address of the successful Tender _____

iii) Contract price of the successful Tender Kenya Shillings _____
(in words _____)

b) The reasons for your tender being unsuccessful are as follows:

c) OtherTenderers

Names of all Tenderers that submitted a Tender. If the Tender's price was evaluated include the evaluated price as well as the Tender price as read out.

SNo	Name of Tender	Tender Price as read out	Tender's evaluated price (Note a)	One Reason Why Not Evaluated
1				
2				
3				
4				
5				

(Note a) State NE if not evaluated

5. How to request a debriefing

- a) DEADLINE: The dead line to request a debriefing expires at midnight on *[insert date]* (local time).
- b) You may request a debriefing in relation to the results of the evaluation of your Tender. If you decide to request a debriefing your written request must be made within three (5) Business Days of receipt of this Notification of Intention to Award.
- c) Provide the contract name, reference number, name of the Tenderer, contact details; and address the request for debriefing as follows:
 - i) Attention: *[insert full name of person, if applicable]*
 - ii) Title/position: *[insert title/position]*
 - iii) Agency: *[insert name of Procuring Entity]*
 - iv) Email address: *[insert email address]*
- d) If your request for a debriefing is received within the 3 Days deadline, we will provide the debriefing within five (3) Business Days of receipt of your request. If we are unable to provide the debriefing within this period, the Standstill Period shall be extended by five (3) Days after the date that the debriefing is provided. If this happens, we will notify you and confirm the date that the extended Standstill Period will end.
- e) The debriefing may be in writing, by phone, video conference call or in person. We shall promptly advise you in writing how the debriefing will take place and confirm the date and time.
- f) If the deadline to request a debriefing has expired, you may still request a debriefing. In this case, we will provide the debriefing as soon as practicable, and normally no later than fifteen (15) Days from the date of publication of the Contract Award Notice.

6. How to make a complaint?

- a) Period: Procurement-related Complaint challenging the decision to award shall be submitted by midnight, *[insert date]* (local time).
- b) Provide the contract name, reference number, name of the Tenderer, contact details; and address the Procurement-related Complaint as follows:
 - i) Attention: *[insert full name of person, if applicable]*
 - ii) Title/position: *[insert title/ position]*
 - iii) Agency: *[insert name of Procuring Entity]*
 - iv) Email address: *[insert email address]*
- c) At this point in the procurement process, you may submit a Procurement-related Complaint challenging the decision to award the contract. You do not need to have requested, or received, a debriefing before making this complaint. Your complaint must be submitted within the Standstill Period and received by us before the Standstill Period ends.
- d) Further information: For more information refer to the Public Procurement and Disposals Act 2015 and its Regulations a available from the Website www.ppra.go.ke.

You should read these documents before preparing and submitting your complaint.

- e) There are four essential requirements:
 - i) You must be an 'interested party'. In this case, that means a Tenderer who submitted a Tender in this tendering process and is the recipient of a Notification of Intention to Award.
 - ii) The complaint can only challenge the decision to award the contract.
 - iii) You must submit the complaint within the period stated above.
 - iv) You must include, in your complaint, all of the information required to support your complaint.

7. Standstill Period

- i) **DEADLINE:** The Standstill Period is due to end at midnight on [*insert date*] (local time).
- ii) The Standstill Period lasts ten (14) Days after the date of transmission of this Notification of Intention to Award.
- iii) The Standstill Period may be extended as stated in paragraph Section 5(d) above.

If you have any questions regarding this Notification please do not hesitate to contact us. On behalf of the Procuring Entity:

Signature: _____

Name: _____

Title/position: _____

Telephone: _____

FORM NO 2: LETTER OF AWARD

[letterhead paper of the Procuring Entity]

[date]

To: *[name and address of the Contractor]*

This is to notify you that your Tender dated *[date]* for execution of the *[name of the Contract and identification number, as given in the Contract Data]* for the Accepted Contract Amount *[amount in numbers and words]* *[name of currency]*, as corrected and modified in accordance with the Instructions to Tenderers, is here by accepted by..... *(name of Procuring Entity)*.

You are requested to furnish the Performance Security within in accordance with the Conditions of Contract, using, for that purpose, one of the Performance Security Forms included in Section VIII, Contract Forms, of the Tender Document.

Authorized Signature:

Name and Title of Signatory:

Name of Procuring Entity:

Attachment: *Contract Agreement*:

FORM NO 3: CONTRACT AGREEMENT

THIS AGREEMENT made the day of..... 20....., between.....
.....of..... (hereinafter “the Procuring Entity”), of the one part, and _____ of _____ (hereinafter “the Contractor”), of the other part:

WHEREAS the Procuring Entity desires that the Works known as _____ should be executed by the Contractor, and has accepted a Tender by the Contractor for the execution and completion of these Works and the remedying of any defects there in,

The Procuring Entity and the Contractor agree as follows:

1. In this Agreement words and expressions shall have the same meanings as are respectively assigned to them in the Contract documents referred to.
2. The following documents shall be deemed to form and be read and construed as part of this Agreement. This Agreement shall prevail over all other Contract documents.
 - a) the Notification of Award
 - b) the Form of Tender
 - c) the addenda Nos _____ (if any)
 - d) the Special Conditions of Contract
 - e) the General Conditions of Contract;
 - f) the Specifications
 - g) the Drawings; and
 - h) the completed Schedules and any other documents forming part of the contract.
3. In consideration of the payments to be made by the Procuring Entity to the Contractor as specified in this Agreement, the Contractor here by covenants with the Procuring Entity to execute the Works and to remedy defects therein in conformity in all respects with the provisions of the Contract.
4. The Procuring Entity here by covenants to pay the Contractor in consideration of the execution and completion of the Works and the remedying of defects there in, the Contract Price or such other sum as may become payable under the provisions of the Contract at the times and in the manner prescribed by the Contract.

IN WITNESS where of the parties here to have caused this Agreement to be executed in accordance with the Laws of Kenya on the day, month and year specified above.

Signed and sealed by _____ (for the Procuring Entity)

Signed and sealed by _____ (for the Contractor).

FORM NO. 4 - PERFORMANCE SECURITY

[Option 1 - Unconditional Demand Bank Guarantee]

[Guarantor letterhead]

Beneficiary: *[insert name and Address of Procuring Entity]*

Date: _____ *[Insert date of issue]*

Guarantor: *[Insert name and address of place of issue, unless indicated in the letterhead]*

1. We have been informed that _____ (hereinafter called "the Contractor") has entered into Contract No. _____ dated _____ with (name of Procuring Entity) _____ (the Procuring Entity as the Beneficiary), for the execution of _____ (hereinafter called "the Contract").
2. Furthermore, we understand that, according to the conditions of the Contract, a performance guarantee is required.
3. At the request of the Contractor, we as Guarantor, here by irrevocably undertake to pay the Beneficiary any sum or sums not exceeding in total an amount of _____ (in words),¹ such sum being payable in the types and proportions of currencies in which the Contract Price is payable, upon receipt by us of the Beneficiary's complying demand supported by the Beneficiary's statement, whether in the demand itself or in a separate signed document accompanying or identifying the demand, stating that the Applicant is in breach of its obligation(s) under the Contract, without the Beneficiary needing to prove or to show grounds for your demand or the sum specified therein.
4. This guarantee shall expire, no later than the.....Day of.....,2.....², and any demand for payment under it must be received by us at the office indicated above on or before that date.
5. The Guarantor agrees to a one-time extension of this guarantee for a period not to exceed *[six months] [one year]*, in response to the Beneficiary's written request for such extension, such request to be presented to the Guarantor before the expiry of the guarantee."

[Name of Authorized Official, signature(s) and seals/stamps]

Note: *All italicized text (including footnotes) is for use in preparing this form and shall be deleted from the final product.*

¹The Guarantor shall insert an amount representing the percentage of the Accepted Contract Amount specified in the Letter of Acceptance, less provisional sums, if any, and denominated either in the currency of the Contract or a freely convertible currency acceptable to the Beneficiary.

²Insert the date twenty-eight days after the expected completion date as described in GC Clause 11.9. The Procuring Entity should note that in the event of an extension of this date for completion of the Contract, the Procuring Entity would need to request an extension of this guarantee from the Guarantor. Such request must be in writing and must be made prior to the expiration date established in the guarantee.

FORM No. 5- PERFORMANCE SECURITY

[Option 2– Performance Bond]

[Note: Procuring Entities are advised to use Performance Security – Unconditional Demand Bank Guarantee in stead of Performance Bond due to difficulties involved in calling Bond holder to action]

[Guarantor letterhead or SWIFT identifier code]

Beneficiary: *[insert name and Address of Procuring Entity]*

Date: _____ *[Insert date of issue]*

PERFORMANCE BOND No.: _____

Guarantor: *[Insert name and address of place of issue, unless indicated in the letterhead]*

1. By this Bond _____ as Principal (hereinafter called “the Contractor”) and _____] as Surety (hereinafter called “the Surety”), are held and firmly bound unto _____] as Obligee (hereinafter called “the Procuring Entity”) in the amount of _____ for the payment of which sum well and truly to be made in the types and proportions of currencies in which the Contract Price is payable, the Contractor and the Surety bind themselves, their heirs, executors, administrators, successors and assigns, jointly and severally, firmly by these presents.
2. WHEREAS the Contractor has entered into a written Agreement with the Procuring Entity dated the _____ day of _____, 20_____, for _____ in accordance with the documents, plans, specifications, and amendments there to, which to the extent here in provided for, are by reference made part here of and are here in after referred to as the Contract.
3. NOW, THEREFORE, the Condition of this Obligation is such that, if the Contractor shall promptly and faithfully perform the said Contract (including any amendments thereto), then this obligation shall be null and void; otherwise, it shall remain in full force and effect. Whenever the Contractor shall be, and declared by the Procuring Entity to be, in default under the Contract, the Procuring Entity having performed the Procuring Entity's obligations there under, the Surety may promptly remedy the default, or shall promptly:
 - a) Complete the Contract in accordance with its terms and conditions; or
 - b) Obtain a tender or tenders from qualified tenderers for submission to the Procuring Entity for completing the Contract in accordance with its terms and conditions, and upon determination by the Procuring Entity and the Surety of the lowest responsive Tenderers, arrange for a Contract between such Tenderer, and Procuring Entity and make a available as work progresses (even though there should be a default or a succession of defaults under the Contract or Contracts of completion arranged under this paragraph) sufficient funds to pay the cost of completion less the Balance of the Contract Price; but not exceeding, including other costs and damages for which the Surety may be liable hereunder, the amount set forth in the first paragraph hereof. The term “Balance of the Contract Price,” as used in this paragraph, shall mean the total amount payable by Procuring Entity to Contractor under the Contract, less the amount properly paid by Procuring Entity to Contractor; or
 - c) Pay the Procuring Entity the amount required by Procuring Entity to complete the Contract in accordance with its terms and conditions upto a total not exceeding the amount of this Bond.
4. The Surety shall not be liable for a greater sum than the specified penalty of this Bond.
5. Any suit under this Bond must be instituted before the expiration of one year from the date of the issuing of the Taking-Over Certificate. No right of action shall accrue on this Bond to or for the use of any person or corporation other than the Procuring Entity named here in or the heirs, executors, administrators, successors, and assigns of the Procuring Entity.
6. In testimony whereof, the Contractor has here unto set his hand and affixed his seal, and the Surety has caused these presents to be sealed with his corporate seal duly at tested by the signature of his legal representative, this day _____ of _____ 20_____.

SIGNED ON _____ on behalf of _____

By _____ in the capacity of _____

In the presence of _____

SIGNED ON _____ on behalf of _____

By _____ in the capacity of _____

In the presence of _____

FORM NO. 6 - ADVANCE PAYMENT SECURITY

[Demand Bank Guarantee]

[Guarantor letterhead]

Beneficiary: _____ *[Insert name and Address of Procuring Entity]*

Date: _____ *[Insert date of issue]*

ADVANCE PAYMENT GUARANTEE No.: *[Insert guarantee reference number]*

Guarantor: *[Insert name and address of place of issue, unless indicated in the letterhead]*

1. We have been informed that _____ (hereinafter called "the Contractor") has entered into Contract No. _____ dated _____ with the Beneficiary, for the execution of _____ (hereinafter called "the Contract").
2. Furthermore, we understand that, according to the conditions of the Contract, an advance payment in the sum _____ (in words _____) is to be made against an advance payment guarantee.
3. At the request of the Contractor, we as Guarantor, here by irrevocably undertake to pay the Beneficiary any sum or sums not exceeding in total an amount of _____ (in words _____) upon receipt by us of the Beneficiary's complying demand supported by the Beneficiary's statement, whether in the demand itself or in a separate signed document accompanying or identifying the demand, stating either that the Applicant:
 - a) Has used the advance payment for purposes other than the costs of mobilization in respect of the Works; or
 - b) Has failed to repay the advance payment in accordance with the Contract conditions, specifying the amount which the Applicant has failed to repay.
4. A demand under this guarantee may be presented as from the presentation to the Guarantor of a certificate from the Beneficiary's bank stating that the advance payment referred to above has been credited to the Contractor on its account number _____ at _____.
5. The maximum amount of this guarantee shall be progressively reduced by the amount of the advance payment repaid by the Contractor as specified in copies of interim statements or payment certificates which shall be presented to us. This guarantee shall expire, at the latest, upon our receipt of a copy of the interim payment certificate indicating that ninety (90) percent of the Accepted Contract Amount, less provisional sums, has been certified for payment, on the _____ day of _____, 2_____,² whichever is earlier. Consequently, any demand for payment under this guarantee must be received by us at this office on or before that date.
6. The Guarantor agrees to a one-time extension of this guarantee for a period not to exceed *[six months] [one year]*, in response to the Beneficiary's written request for such extension, such request to be presented to the Guarantor before the expiry of the guarantee.

[Name of Authorized Official, signature(s) and seals/stamps]

Note: *All italicized text (including footnotes) is for use in preparing this form and shall be deleted from the final product.*

¹The Guarantor shall insert an amount representing the amount of the advance payment and denominated either in the currency of the advance payment as specified in the Contract.

²Insert the expected expiration date of the Time for Completion. The Procuring Entity should note that in the event of an extension of the time for completion of the Contract, the Procuring Entity would need to request an extension of this guarantee from the Guarantor. Such request must be in writing and must be made prior to the expiration date established in the guarantee.

FORM NO. 7 – RETENTION MONEY SECURITY

[Demand Bank Guarantee]

[Guarantor letterhead]

Beneficiary: _____ *[Insert name and Address of Procuring Entity]*

Date: _____ *[Insert date of issue]*

Advance payment guarantee no. *[Insert guarantee reference number]*

Guarantor: *[Insert name and address of place of issue, unless indicated in the letterhead]*

1. We have been informed that _____ *[insert name of Contractor, which in the case of a joint venture shall be the name of the joint venture]* (hereinafter called "the Contractor") has entered into Contract No. _____ *[insert reference number of the contract]* dated _____ with the Beneficiary, for the execution of _____ *[insert name of contract and brief description of Works]* (hereinafter called "the Contract").
2. Furthermore, we understand that, according to the conditions of the Contract, the Beneficiary retains moneys upto the limit set forth in the Contract ("the Retention Money"), and that when the Taking-Over Certificate has been issued under the Contract and the first half of the Retention Money has been certified for payment, and payment of *[insert the second half of the Retention Money]* is to be made against a Retention Money guarantee.
3. At the request of the Contractor, we, as Guarantor, hereby irrevocably undertake to pay the Beneficiary any sum or sums not exceeding in total an amount of *[insert amount in figures]* _____ *([insert amount in words _____])*¹ upon receipt by us of the Beneficiary's complying demands supported by the Beneficiary's statement, whether in the demand itself or in a separate signed document accompanying or identifying the demand, stating that the Contractor is in breach of its obligation(s) under the Contract, without your needing to prove or show grounds for your demand or the sum specified there in.
4. A demand under this guarantee may be presented as from the presentation to the Guarantor of a certificate from the Beneficiary's bank stating that the second half of the Retention Money as referred to above has been credited to the Contractor on its account number _____ at _____ *[insert name and address of Applicant's bank]*.
5. This guarantee shall expire no later than the.....Day of.....², and any demand for payment under it must be received by us at the office indicated above on or before that date.
6. The Guarantor agrees to a one-time extension of this guarantee for a period not to exceed *[six months]* *[one year]*, in response to the Beneficiary's written request for such extension, such request to be presented to the Guarantor before the expiry of the guarantee.

[Name of Authorized Official, signature(s) and seals/stamps]

Note: *All italicized text (including footnotes) is for use in preparing this form and shall be deleted from the final product.*

¹The Guarantor shall insert an amount representing the amount of the second half of the Retention Money.

²Insert a date that is twenty-eight days after the expiry of retention period after the actual completion date of the contract. The Procuring Entity should note that in the event of an extension of this date for completion of the Contract, the Procuring Entity would need to request an extension of this guarantee from the Guarantor. Such request must be in writing and must be made prior to the expiration date established in the guarantee

PARTICULAR PRELIMINARIES

ITEM	DESCRIPTION	AMOUNT (Kshs.)
	<p style="text-align: center;">PARTICULAR PRELIMINARIES</p> <p>A EMPLOYER KARUMO TECHNICAL TRAINING INSTITUTE</p> <p>The term "Employer" and "Government" wherever used in the contract document shall be synonymous</p> <p>B LOCATION OF SITE The site of the proposed works is at Karumo Technical Training Institute - Meru County</p> <p>The Contractor is advised to visit the site, to familiarize with the nature and position of the site. No claims arising from the Contractor's failure to do so will be entertained.</p> <p>C DESCRIPTION OF THE WORKS The works to be carried out under this contract comprise Construction of tuition block - ground floor and first floor and associated electrical and mechanical works</p> <p>D FORM OF CONTRACT The Form of Contract shall be as stipulated in the Republic of Kenya's Standard Tender Document for Procurement of Building Works (2021 Edition) included herein The Conditions of Contract are also included herein Conditions of Contract. Particulars of insertions to be made in the Appendix to the Contract Agreement will be found in the Particular Preliminaries part of these Bills of Quantities</p>	
	Total carried to summary	

ITEM	DESCRIPTION	AMOUNT (Kshs.)
<p>A</p> <p>BID BOND</p> <p>A bid bond shall be required in the amount stated here or in the invitation to tender or advertisement</p> <p>Bid bond shall be from EITHER an insurance or bank.</p> <p>B</p> <p>CLEARING AWAY</p> <p>The Contractor shall remove all temporary works, rubbish, debris and surplus materials from the site as they accumulate and upon completion of the works, remove and clear away all plant, equipment, rubbish, unused materials and stains and leave in a clean and tidy state to the reasonable satisfaction of the Project Manager.</p> <p>The whole of the works shall be delivered up clean, complete and in perfect condition in every respect to the satisfaction of the Project Manager.</p> <p>C</p> <p>WORKING CONDITIONS</p> <p>These are works to be undertaken in an existing building.</p> <p>The contractor must allow for compliance with all County & Civic Authority laws & regulations</p> <p>D</p> <p>CLAIMS</p> <p>It shall be a condition of this contract that upon it becoming reasonably apparent to the Contractor that he has incurred losses and/or expenses due to any of the contract conditions, or by any other reason whatsoever, he shall present such claim or intent to claim notice to the PROJECT MANAGER within the contract period. No claims shall be entertained upon the expiry of the said contract period.</p> <p>E</p> <p>LABOUR CAMPS</p> <p>The Contractor shall not be allowed to house labour on site. Allow for transporting workers to and from the site during the tenure of the contract.</p> <p>F</p> <p>PRICING RATES</p> <p>The tenderer shall fill in rates and prices for all items of the Works described in the Bill of Quantities.</p> <p>Items for which no rate or price is entered by the tenderer will not be paid for when executed and shall be deemed covered by the other rates and prices in the Bill of Quantities.</p> <p>The tenderer shall include for all costs in executing the whole of the works, including transport, replacing damaged items, fixing, all to comply with the said Conditions of Contract.</p> <p>Prices quoted should be net inclusive of all taxes, must be in Kenya shillings</p> <p>Prices shall remain valid for One Hundred and twenty (120) days from the closing date of tender.</p> <p>The rates and prices quoted by the tenderer shall only be subject to adjustment during the performance of the Contract if provided for in the Appendix to Conditions of Contract and provisions made in the Conditions of Contract.</p>		
	Total carried to summary	

ITEM	DESCRIPTION	AMOUNT (Kshs.)
<p>A</p> <p>MATERIALS FROM DEMOLITIONS Any materials arising from demolitions SHALL NOT BE re-used shall become the property of the client unless otherwise advised.</p> <p>B</p> <p>URGENCY OF THE WORKS The Contractor is notified that these “works are urgent” and should be completed within the period stated in these Particular Preliminaries. The Contractor shall allow in his rates for any costs he deems that he/she may incur by having to complete the works within the stipulated contract period.</p> <p>C</p> <p>PAYMENTS GENERALLY The contractor is advised to deliver & concur on his claim for payment with the PM before the following site visit to enable approval of the same by the Acceptance & Approval Committee. The claim shall be prepared in the same format as these bills clearly showing quantities & rates (both work & materials). Both the PM & contractor should be able to locate & identify the items claimed from the main bill. The last contractual claim/invoice for the relevant financial year should reach the PM by 30th May. Latter claims shall not be processed for payment in the current year.</p> <p>D</p> <p>PAYMENT FOR MATERIALS ON SITE All materials for incorporation in the works must be stored on site before payment is effected, unless specifically exempted by the Project Manager. This is to include materials of the Contractor, nominated sub-Contractors and nominated suppliers.</p> <p>E</p> <p>ADVANCE PAYMENTS The tenderer’s attention is drawn to the fact that the Government does not make any advance payments.</p> <p>F</p> <p>EXISTING SERVICES Prior to the commencement of any work, the Contractor is to ascertain from the relevant authority the exact position, depth and level of all existing services in the area and he/she shall make whatever provisions may be required by the authorities concerned for the support, maintenance and protection of such services.</p> <p>G</p> <p>TENDER DOCUMENTS Tender documents are as listed in Clause 2.1 of the Instruction to Tenderer’s Page 8</p>		
	Total carried to summary	

ITEM	DESCRIPTION	AMOUNT (Kshs.)
A	<p>DELIVERY OF TENDER Tenders and all documents in connection therewith, as specified above must be delivered in the addressed envelope which should be properly sealed and deposited at the offices as specified in the letter accompanying these documents or as indicated in the advertisement.</p> <p>Tenders will be opened at the time specified in the letter accompanying these Tender Documents or as indicated in the advertisement. Tenders delivered/received later than the above time will not be opened.</p>	
B	<p>MEASUREMENTS</p> <p>In the event of any discrepancies arising between the Bills of Quantities and the actual works, the site measurements shall generally take precedence. However, such discrepancies between any contract documents shall immediately be referred to the PROJECT MANAGER in accordance with Clause 12 of the Conditions of Contract. The discrepancies shall then be treated as a variation and be dealt with in accordance with Clause 12 of the said Conditions.</p>	
C	<p>VALUE ADDED TAX The Contractor's attention is drawn to the Legal Notice in the Finance Act part 3 Section 21(b) operative from 1st September, 1993 which requires payment of VAT on all contracts.</p> <p>In accordance with Government public notice No. 35 & 36 Dated 11th September 2003 operational from 1st October 2003, withholding VAT was to be levied against the contract sum by the Employer and remitted to the Commissioner of VAT through all interim certificates.</p>	
D	<p>THE CURRENT LAWS ON THIS SUBJECT SHALL APPLY The contractor should include this tax in the RATES and NOT in the Grand Summary.</p>	
E	<p>SPECIAL PRELIMINARIES</p> <p>Allow a provisional Sum of Kenya Shillings Two Million (KShs. 2,000,000) only for transport charges , subsistence allowances & airtime allowance for State Department for Public Works staff to be expended as directed by the PM</p> <p>Allow a percentage sum for the contractors administrative costs, profits and taxes for the above (%)</p> <p>Allow a provisional Sum of Kenya Shillings Three Hundred Thousand (KShs. 300,000) only for Project Manager Stationery</p> <p>Allow a percentage sum for the contractors administrative costs, profits and taxes for the above (%)</p>	<p>2,000,000.00</p> <p>300,000.00</p>
	Total carried to summary	

ITEM	DESCRIPTION	AMOUNT (Kshs.)
PARTICULARS OF INSERTIONS TO BE MADE IN APPENDIX TO CONTRACT AGREEMENT		
The following are the insertions to be made in the appendix to the contract Agreement:-		
A	Period of Final Measurement 3 Months from Practical Completion	
B	Defects Liability Period 6 Months from Practical Completion	
C	Date for Possession To be agreed with the Project Manager	
D	Date for Completion To be agreed with the Project Manager	
E	Liquidated and Ascertained Damages 0.01% of the contract price per day	
F	Period of Interim Certificates Monthly	
G	Period of Honouring Certificates 30 Days	
H	Percentage of Certified Value Retained 10%	
I	Limit of Retention Fund 10 %	
Total carried to summary		
<u>SUMMARY</u>		

ITEM	DESCRIPTION	AMOUNT (Kshs.)
	Brought forward from page PP/1 Brought forward from page PP/2 Brought forward from page PP/3 Brought forward from page PP/4 Brought forward from page PP/5	
	TOTAL CARRIED TO GRAND SUMMARY	

GENERAL PRELIMINARIES

ITEM	DESCRIPTION	AMOUNT (Kshs.)
	<p style="text-align: center;">GENERAL PRELIMINARIES</p> <p>A. PRICING OF ITEMS OF PRELIMINARIES AND PREAMBLES</p> <p>Prices will be inserted against items of Preliminaries in the Contractor's priced Bills of Quantities and Specification.</p> <p>The Contractor shall be deemed to have included in his prices or rates for the various items in the Bills of Quantities or Specification for all costs involved in complying with all the requirements for the proper execution of the whole of the works in the Contract.</p> <p>Failure to price an item shall not exempt the contractor from carrying out works described therein.</p> <p>Should the contractor fail to carry out works which he/she did not price and after having received a written instruction from the PM, then the value of such works shall be deducted from the very immediate certificate issued to the contractor.</p> <p>MoPW current rates, IQSK, manufacturers or fair rates shall be used by the PM in valuation of unpriced items which the contractor shall fail to execute.</p> <p>The contractor is advised to read and understand all preliminary items. The Contractor is advised to visit the site, to familiarize with the nature and position of the site. No claims arising from the Contractor's failure to do so will be entertained.</p> <p>B FIRM PRICE CONTRACT</p> <p>Unless otherwise specifically stated in the Contract Data and/or Particular preliminaries this is a firm price contract and the contractor must allow in his tender rates for any increase in the cost of labour and/or materials during the currency of the contract.</p> <p>C VISIT SITE AND EXAMINE DRAWINGS.</p> <p>The Contractor is recommended to examine the drawings and visit the site the location of which is described in the Particular Preliminaries hereof. He shall be deemed to have acquainted himself therewith as to its nature, position, means of access or any other matter which, may affect his tender. No claim arising from his failure to comply with this recommendation will be considered.</p>	
	Total carried to summary	

ITEM	DESCRIPTION	AMOUNT (Kshs.)
<p>A</p>	<p>BONDS.</p> <p>The Contractor shall find and submit on the Form of Tender a guarantor and who will be willing to be bound the Government in the amount of the bond.</p> <p>The amount of the bond is SPECIFIED IN THE PARTICULAR PRELIMINARIES</p> <p>The guarantor shall be an approved institution as specified in the particular preliminaries or invitation to tender and who will when and if called upon, sign a Bond to that effect on the relevant standard form included herein. (without the addition of any limitations) on the same day as the Contract Agreement is signed, by the Government, the Contractor shall furnish within seven days another Surety to the approval of the Government.</p>	
	<p>B</p> <p>PERFORMANCE BOND</p> <p>5% bond shall be required from the specified institution</p> <p>The period for supplying the bond shall be 14 days.</p> <p>No contract shall be signed, NOR shall any payment be made before the bidder has complied with the bond requirements</p> <p>Failure to deliver the bond within the specified period shall automatically disqualify the bidder and the tender shall be awarded to next most responsive bidder without reference to the defaulting bidder.</p> <p>Should the bidder commence works and subsequently fail to provide the bond, he shall be evicted from site without any reimbursement notwithstanding the site having been handed over by the PM and client. The handing over only kickstarts the process and is not a waiver to bond conditions.</p> <p>The bond for the due performances of the Contract shall be valid up to the date of completion as certified by the PROJECT MANAGER</p> <p>Any bond which provides otherwise or attempts to vary the duration of validity shall be invalid</p> <p>The bond shall comply in all respects with the PPOA copy enclosed in the instructions to tender. A bond that does not match the PPOA copy shall be treated as NO BOND</p> <p>The contractor shall provide a bid security duly signed, sealed and stamped from an approved Bank of required amount in the particular preliminaries</p>	
	<p>Total carried to summary</p>	

ITEM	DESCRIPTION	AMOUNT (Kshs.)																										
A	<p>EXCEPTION TO THE STANDARD METHOD OF MEASUREMENT</p> <p>Attendance ; Clause B19(a) of the Standard Method of Measurement is deleted and the following clause is substituted:-</p> <p>Attendance on nominated Sub-Contractors shall be given as an item in each case shall be deemed to include: allowing use of standing scaffolding, mess rooms, sanitary accommodation and welfare facilities; provision of special scaffolding where necessary;providing space for office accommodation and for storage of plant and materials;providing light and water for their work: clearing away rubbish; unloading checking and hoisting: providing electric power and removing and replacing duct covers, pipe casings and the like necessary for the execution and testing of Sub-Contractors' work and being responsible for the accuracy of the same.</p> <p>Fix Only:-</p> <p>"Fix Only" shall mean take delivery at nearest railway station (Unless otherwise stated), pay all demurrage charges, load and transport to site where necessary, unload, store, unpack, assemble as necessary, distribute to position, hoist and fix only.</p>																											
B	<p>ABBREVIATIONS</p> <p>Throughout these Bills units of measurement and terms are abbreviated and shall be interpreted as follows:-</p> <table border="0" data-bbox="245 1071 1224 1722"> <tr> <td>CM or Cm</td> <td>Shall mean cubic meter</td> </tr> <tr> <td>SM or Sm</td> <td>Shall mean square meter</td> </tr> <tr> <td>LM or Lm</td> <td>Shall mean linear meter</td> </tr> <tr> <td>MM or mm</td> <td>Shall mean Millimeter</td> </tr> <tr> <td>KG or Kg.</td> <td>Shall mean Kilogramme</td> </tr> <tr> <td>No or Nr</td> <td>Shall mean Number</td> </tr> <tr> <td>PRS or Prs.</td> <td>Shall mean Pairs</td> </tr> <tr> <td>B.S.</td> <td>Shall mean the British Standard Specification Published by the British Standards Institution, 2 Park Street, London W.I England</td> </tr> <tr> <td>M.S.</td> <td>Shall mean measured separately</td> </tr> <tr> <td>Ditto</td> <td>shall mean the whole of the preceding description except as qualified in the description in which it occurs.</td> </tr> <tr> <td>Do</td> <td>shall mean the whole of the preceding description except as qualified in the description in which it occurs.</td> </tr> <tr> <td>a.b.</td> <td>Shall mean as before described</td> </tr> <tr> <td>a.b.d.</td> <td>Shall mean as before described</td> </tr> </table>	CM or Cm	Shall mean cubic meter	SM or Sm	Shall mean square meter	LM or Lm	Shall mean linear meter	MM or mm	Shall mean Millimeter	KG or Kg.	Shall mean Kilogramme	No or Nr	Shall mean Number	PRS or Prs.	Shall mean Pairs	B.S.	Shall mean the British Standard Specification Published by the British Standards Institution, 2 Park Street, London W.I England	M.S.	Shall mean measured separately	Ditto	shall mean the whole of the preceding description except as qualified in the description in which it occurs.	Do	shall mean the whole of the preceding description except as qualified in the description in which it occurs.	a.b.	Shall mean as before described	a.b.d.	Shall mean as before described	
CM or Cm	Shall mean cubic meter																											
SM or Sm	Shall mean square meter																											
LM or Lm	Shall mean linear meter																											
MM or mm	Shall mean Millimeter																											
KG or Kg.	Shall mean Kilogramme																											
No or Nr	Shall mean Number																											
PRS or Prs.	Shall mean Pairs																											
B.S.	Shall mean the British Standard Specification Published by the British Standards Institution, 2 Park Street, London W.I England																											
M.S.	Shall mean measured separately																											
Ditto	shall mean the whole of the preceding description except as qualified in the description in which it occurs.																											
Do	shall mean the whole of the preceding description except as qualified in the description in which it occurs.																											
a.b.	Shall mean as before described																											
a.b.d.	Shall mean as before described																											
	Total carried to summary																											

ITEM	DESCRIPTION	AMOUNT (Kshs.)
<p>A</p>	<p>EMPLOYER</p> <p>The “Employer” is AS DEFINED UNDER PARTICULAR PRELIMINARIES</p> <p>The term "Employer" and "Government" wherever used in the contract document shall be synonymous</p>	
<p>B</p>	<p>PROJECT MANAGER shall be -:</p> <p>The term "P.M." wherever used in these Bills of Quantities shall be deemed to imply the Project Manager as defined in Condition 1 of the Conditions of Contract or such person or persons as may be duly authorised to represent him on behalf of the Government.</p> <p>In this Project, the PM shall be -: REGIONAL WORKS OFFICER - EASTERN REGION STATE DEPARTMENT FOR PUBLIC WORKS P.O. BOX 455-60100 EMBU</p>	
<p>C</p>	<p>ARCHITECT</p> <p>The term "Architect" shall be deemed to mean "The P.M." as defined above whose address unless otherwise notified is as above</p>	
<p>D</p>	<p>QUANTITY SURVEYOR</p> <p>The term "Quantity Surveyor" shall be deemed to mean "The P.M." as defined above whose address unless otherwise notified is as above</p>	
<p>E</p>	<p>ELECTRICAL ENGINEER</p> <p>The term "Electrical Engineer" shall be deemed to mean "The P.M." as defined above whose address unless otherwise notified is as above</p>	
<p>F</p>	<p>MECHANICAL ENGINEER</p> <p>The term "Mechanical Engineer" shall be deemed to mean "The P.M." as defined above whose address unless otherwise notified is as above</p>	
<p>G</p>	<p>STRUCTURAL ENGINEER</p> <p>The term "Structural Engineer" shall be deemed to mean "The P.M." as defined above whose address unless otherwise notified is as above</p>	
	Total carried to summary	

ITEM	DESCRIPTION	AMOUNT (Kshs.)
<p>A</p>	<p>PLANT, TOOLS AND VEHICLES</p> <p>Allow for providing all scaffolding, plant, tools and vehicles required for the work except in so far as may be stated otherwise herein and except for such items specifically and only required for the use of nominated Sub-Contractors as described herein. No timber used for scaffolding, formwork or temporary works of any kind shall be used afterwards in the permanent work.</p>	
<p>B</p>	<p>TRANSPORT.</p> <p>Allow for transport of workmen, materials, etc., to and from the site at such hours and by such routes as may be permitted by the competent authorities.</p>	
<p>C</p>	<p>MATERIALS AND WORKMANSHIP.</p> <p>All materials and workmanship used in the execution of the work shall be of the best quality and description unless otherwise stated. The Contractor shall order all materials to be obtained from overseas immediately after the Contract is signed and shall also order materials to be obtained from local sources as early as necessary to ensure that they are onsite when required for use in the works. The Bills of Quantities shall not be used for the purpose of ordering materials.</p>	
<p>D</p>	<p>SIGN FOR MATERIALS SUPPLIED.</p> <p>The Contractor will be required to sign a receipt for all articles and materials supplied by the PROJECT MANAGER at the time of taking delivery thereof, as having received them in good order and condition, and will thereafter be responsible for any loss or damage and for replacements of any such loss or damage with articles and/or materials which will be supplied by the PROJECT MANAGER at the current market prices including Customs Duty and V.A.T., all at the Contractor's own cost and expense, to the satisfaction of the PROJECT MANAGER</p>	
<p>E</p>	<p>STORAGE OF MATERIALS</p> <p>The Contractor shall provide at his own risk and cost where directed on the site weather proof lock-up sheds and make good damaged or disturbed surfaces upon completion to the satisfaction of the PROJECT MANAGER. Nominated Sub-Contractors are to be made liable for the cost of any storage accommodation provided especially for their use.</p>	
	<p>Total carried to summary</p>	

ITEM	DESCRIPTION	AMOUNT (Kshs.)
<p>A</p>	<p>SAMPLES The Contractor shall furnish at his own cost any samples of materials or workmanship including concrete test cubes required for the works that may be called for by the PROJECT MANAGER for his approval until such samples are approved by the PROJECT MANAGER and the PROJECT MANAGER, may reject any materials or workmanship not in his opinion to be up to approved samples. The PROJECT MANAGER shall arrange for the testing of such materials as he may at his discretion deem desirable, but the testing shall be made at the expense of the Contractor and not at the expense of the PROJECT MANAGER PROVIDED THEY PASS THE TEST. The Contractor shall pay for the testing in accordance with the current scale of testing charges laid down by the Ministry of Public Works. The procedure for submitting samples of materials for testing and the method of marking for identification shall be as laid down by the PROJECT MANAGER The Contractor shall allow in his tender for such samples and tests except those in connection with nominated sub-contractors' work.</p> <p>Samples of paint, carpets, curtains & covers, tiles & timber shall be required for approval by the PM together with the employer.</p> <p>No alternte rate shall be offered on account that the employer has chosen a superior finish unless the bidder had attached the sample he priced.</p>	
<p>B</p>	<p>PUBLIC AND PRIVATE ROADS. Maintain as required throughout the execution of the works and make good any damage to public or private roads arising from or consequent upon the execution of the works to the satisfaction of the local and other competent authority and the PROJECT MANAGER</p>	
<p>C</p>	<p>EXISTING PROPERTY. The Contractor shall take every precaution to avoid damage to all existing property including roads, cables, drains and other services and he will be held responsible for and shall make good all such damage arising from the execution of this contract at his own expense to the satisfaction of the PROJECT MANAGER</p>	
<p>D</p>	<p>ACCESS TO SITE AND TEMPORARY ROADS. Means of access to the Site shall be agreed with the PROJECT MANAGER prior to commencement of the work and Contractor must allow for building any necessary temporary access roads for the transport of the materials, plant and workmen as may be required for the complete execution of the works including the provision of temporary culverts, crossings, bridges, or any other means of gaining access to the Site. Upon completion of the works, the Contractor shall remove such temporary access roads; temporary culverts, bridges, etc., and make good and reinstate all works and surfaces disturbed to the satisfaction of the PROJECT MANAGER</p>	
	<p>Total carried to summary</p>	

ITEM	DESCRIPTION	AMOUNT (Kshs.)
<p>A</p> <p>B</p> <p>C</p> <p>D</p> <p>D</p>	<p>AREA TO BE OCCUPIED BY THE CONTRACTOR The area of the site which may be occupied by the Contractor for use of storage and for the purpose of erecting workshops, etc., shall be defined on site by the PROJECT MANAGER</p> <p>SECURITY OF WORKS ETC. The Contractor shall be entirely responsible for the security of all the works stores, materials, plant, personnel, etc., both his own and sub-contractors' and must provide all necessary watching, lighting and other precautions as necessary to ensure security against theft, loss or damage and the protection of the public.</p> <p>PROGRESS CHART. The Contractor shall provide within two weeks of Possession of Site and in agreement with the PROJECT MANAGER a Progress Chart for the whole of the works including the works of Nominated Sub-Contractors ; one copy to be handed to the PROJECT MANAGER and a further copy to be retained on Site. Progress to be recorded and chart to be amended as necessary as the work proceeds.</p> <p>INSURANCE The Contractor shall insure as required in Conditions No. 30 of the Conditions of Contract. No payment on account of the work executed will be made to the Contractor until he has satisfied the PROJECT MANAGER either by production of an Insurance Policy or and Insurance Certificate that the provision of the foregoing Insurance Clauses have been complied with in all respects. Thereafter the PROJECT MANAGER shall from time to time ascertain that premiums are duly paid up by the Contractor who shall if called upon to do so, produce the receipted premium renewals for the PROJECT MANAGER's inspection.</p> <p>CONTRACTOR'S SUPERINTENDENCE/SITE AGENT The Contractor shall constantly keep on the works a literate English speaking Agent or Representative, competent and experienced in the kind of work involved who shall give his whole experience in the kind of work involved and shall give his whole time to the superintendence of the works. Such Agent or Representative shall receive on behalf of the Contractor all directions and instructions from the Project Manager and such directions shall be deemed to have been given to the Contractor in accordance with the Conditions of Contract.</p>	
	Total carried to summary	

ITEM	DESCRIPTION	AMOUNT (Kshs.)
<p>A</p>	<p>PROVISIONAL WORK All work described as "Provisional" in these Bills of Quantities is subject to remeasurement in order to ascertain the actual quantity executed for which payment will be made. All "Provisional" and other work liable to adjustment under this Contract shall left uncovered for a reasonable time to allow all measurements needed for such adjustment to be taken by the PROJECT MANAGER Immediately the work is ready for measuring, the Contractor shall give notice to the PROJECT MANAGER. If the Contractor makes default in these respects he shall if the PROJECT MANAGER so directs uncover the work to enable all measurements to be taken and afterwards reinstate at his own expense.</p>	
<p>B</p>	<p>PROVISIONAL SUMS. The term "Provisional Sum" wherever used in these Bills of Quantities shall have the meaning stated in Section A item A7(i) of the Standard Method of Measurement. Such sums are net and no addition shall be made to them for profit.</p>	
<p>C</p>	<p>ADJUSTMENT OF PROVISIONAL SUMS. In the final account all Provisional Sums shall be deducted and the value of the work properly executed in respect of them upon the PROJECT MANAGER's order added to the Contract Sum. Such work shall be valued , but should any part of the work be executed by a Nominated Sub-Contractor, the value of such work or articles for the work to be supplied by a Nominated Supplier, the value of such work or articles shall be treated as a P.C. Sum and profit and attendance comparable to that contained in the priced Bills of Quantities for similar items added.</p>	
<p>D</p>	<p>PRIME COST (OR P.C.) SUMS. The term "Prime Cost Sum" or "P.C. Sum" wherever used in these Bills of Quantities shall have the meaning stated in Section A item A7 (ii) of the Standard Method of Measurement . Persons or firms nominated by the PROJECT MANAGER to execute work or to provide and fix materials or goods are described herein as Nominated Sub-Contractors. Persons or firms so nominated to supply goods or materials are described herein as Nominated Suppliers.</p>	
	Total carried to summaries	

ITEM	DESCRIPTION	AMOUNT (Kshs.)
<p>A</p> <p>B</p> <p>A</p> <p>B</p>	<p>ADJUSTMENT OF P.C. SUMS. In the final account all P.C. Sums shall be deducted and the amount properly expended upon the PROJECT MANAGER'S order in respect of each of them added to the Contract sum. The Contractor shall produce to the PROJECT MANAGER such quotations, invoices or bills, properly receipted, as may be necessary to show the actual details of the sums paid by the Contractor. Items of profit upon P.C. Sums shall be adjusted in the final account pro-rata to the amount paid. Items of "attendance" (as previously described) following P.C. Sums shall be adjusted pro-rata to the physical extent of the work executed (not pro-rata to the amount paid) and this shall apply even though the Contractor's priced Bill shows a percentage in the rate column in respect of them. Should the Contractor be permitted to tender and his tender be accepted of any work for which a P.C. Sum is included in these Bill of Quantities profit and attendance will be allowed at the same rate as it would be if the work were executed by a Nominated Sub-Contractor.</p> <p>NOMINATED SUB-CONTRACTORS When any work is ordered by the PROJECT MANAGER to be executed by nominated sub-contractors, the Contractor shall enter into sub-contracts and shall thereafter be responsible for such sub-contractors in every respect. Unless otherwise described the Contractor is to provide for such Sub-Contractors any or all of the facilities described in these Preliminaries. The Contractor should price for these with the nominated Sub-contract Contractor's work concerned in the P.C. Sums under the description "add for Attendance".</p> <p>DIRECT CONTRACTS Notwithstanding the foregoing conditions, the Government reserves the right to place a "Direct Contract" for any goods or services required in the works which are covered by a P.C. Sum in the Bills of Quantities and to pay for the same direct. In any such instances, profit relative to the P.C. Sum the priced Bills of Quantities will be adjusted as described for P.C. Sums and allowed.</p> <p>ATTENDANCE UPON OTHER TRADESMEN, ETC. The Contractor shall allow for the attendance of trade upon trade and shall afford any tradesmen or other persons employed for the execution of any work not included in this Contract every facility for carrying out their work and also for use of his ordinary scaffolding. The Contractor, however, shall not be required to erect any special scaffolding for them. The Contractor shall perform such cutting away for and making good after the work of such tradesmen or persons as may be ordered by the PROJECT MANAGER and the work will be measured and paid for to the extent executed at rates provided in these Bills.</p>	
	Total carried to summary	

ITEM	DESCRIPTION	AMOUNT (Kshs.)
A	<p>OFFICE ETC. FOR THE PROJECT MANAGER</p> <p>The Contractor shall provide, erect and maintain where directed on site and afterwards dismantle the site office of the type noted in the Particular Preliminaries, complete with Furniture. He shall also provide a strong metal trunk complete with strong hasp and staple fastening and two keys. He shall provide, erect and maintain a lock-up type water or bucket closet for the sole use of the PROJECT MANAGER including making temporary connections to the drain where applicable to the satisfaction of Government and Medical Officer of Health and shall provide services of cleaner and pay all conservancy charges and keep both office and closet in a clean and sanitary condition from commencement to the completion of the works and dismantle and make good disturbed surfaces. The office and closet shall be completed before the Contractor is permitted to commence the works. The Contractor shall make available on the Site as and when required by the "PROJECT MANAGER" a modern and accurate level together with levelling staff, ranging rods and 50 metre metallic or linen tape.</p>	
B	<p>WATER AND ELECTRICITY SUPPLY FOR THE WORKS</p> <p>The Contractor shall provide at his own risk and cost all necessary water, electric light and power required for use in the works. The Contractor must make his own arrangements for connection to the nearest suitable water main and for metering the water used. He must also provide temporary tanks and meters as required at his own cost and clear away when no longer required and make good on completion to the entire satisfaction of the PROJECT MANAGER . The Contractor shall pay all charges in connection herewith. No guarantee is given or implied that sufficient water will be available from mains and the Contractor must make his own arrangements for augmenting this supply at his own cost. Nominated Sub--contractors are to be made liable for the cost of any water or electric current used and for any installation provided especially for their own use.</p>	
B	<p>SANITATION OF THE WORKS</p> <p>The Sanitation of the works shall be arranged and maintained by the Contractor to the satisfaction of the Government and/or Local Authorities, Labour Department and the PROJECT MANAGER</p>	
C	<p>SUPERVISION AND WORKING HOURS</p> <p>The works shall be executed under the direction and to the entire satisfaction in all respects of the PROJECT MANAGER who shall at all times during normal working hours have access to the works and to the yards and workshops of the Contractor and sub-Contractors or other places where work is being prepared for the contract.</p>	
D	<p>PROTECTION OF THE WORKS.</p> <p>Provide protection of the whole of the works contained in the Bills of Quantities,including casing , casing up, covering or such other means as may be necessary to avoid damage to the satisfaction of the PROJECT MANAGER and remove such protection when no longer required and make good any damage which may nevertheless have been done at completion free of cost to the Government.</p>	
	Total carried to summary	

ITEM	DESCRIPTION	AMOUNT (Kshs.)
<p>A</p> <p>WORKS TO BE DELIVERED UP CLEAN</p> <p>Clean and flush all gutters, rainwater and waste pipes, manholes and drains, wash (except where such treatment might cause damage) and clean all floors, sanitary fittings, glass inside and outside and any other parts of the works and remove all marks, blemishes, stains and defects from joinery, fittings and decorated surfaces generally, polish door furniture and bright parts of metalwork and leave the whole of the buildings watertight, clean, perfect and fit for occupation to the approval of the PROJECT MANAGER</p> <p>B</p> <p>GENERAL SPECIFICATION.</p> <p>For the full description of materials and workmanship, method of execution of the work and notes for pricing, the Contractor is referred to the Ministry of Roads and Public Works and Housing General Specification dated 1976 or any subsequent revision thereof which is issued as a separate document, and which shall be allowed in all respects unless it conflicts with the General Preliminaries, Trade Preambles or other items in these Bills of Quantities.</p> <p>C</p> <p>TRAINING LEVY</p> <p>The Contractor's attention is drawn to legal notice No. 237 of October, 1971, which requires payment by the Contractor of a Training Levy at the rate of 1/4 % of the Contract sum on all contracts of more than Kshs. 50,000.00 in value.</p> <p>D</p> <p>MATERIALS ON SITE</p> <p>All materials for incorporation in the works must be stored on or adjacent to the site before payment is effected unless specifically exempted by the PROJECT MANAGER. This includes the materials of the Main Contractor, Nominated Sub-Contractors and Nominated Suppliers.</p> <p>E</p> <p>HOARDING</p> <p>The Contractor shall enclose the site or part of the works under construction with a hoarding 2400 mm high consisting of iron sheets on 100 x 50 mm timber posts firmly secured at 1800 mm centres with two 75 x 50 mm timber rails for a total length of approximately three hundred meters. The Contractor is in addition required to take all precautions necessary for the safe custody of the works, materials, plant, public and Employer's property on the site.</p> <p>F</p> <p>ALTERATIONS TO BILLS, PRICING, ETC.</p> <p>Any unauthorised alteration or qualification made to the text of the Bills of Quantities may cause the Tender to be disqualified and will in any case be ignored. The Contractor shall be deemed to have made allowance in his prices generally to cover any items against which no price has been inserted in the priced Bills of Quantities. All items of measured work shall be priced in detail and the Tenders containing Lump Sums to cover trades or groups of work must be broken down to show the price of each item before they will be accepted.</p>		
	Total carried to summary	

ITEM	DESCRIPTION	AMOUNT (Kshs.)
A	<p>MATERIALS ARISING FROM EXCAVATIONS Materials of any kind obtained from the excavations shall be the property of the Government. Unless otherwise provided for in the particular preliminaries. Such materials shall only be used in the works, in substitution of materials which the Contractor would otherwise have had to supply with the written permission of the PROJECT MANAGER Should such permission be given, the Contractor shall make due allowance for the value of the materials so used at a price to be agreed.</p>	
B	<p>PREVENTION OF ACCIDENT, DAMAGE OR LOSS The Contractor is notified that these works are to be carried out on a restricted site where the client is going on with other normal activities. The Contractor is instructed to take reasonable care in the execution of the works as to prevent accidents, damage or loss and disruption of normal activities being carried out by the Client. The Contractor shall allow in his rates any expense he deems necessary by taking such care within the site.</p>	
C	<p>GOVERNMENT ACTS REGARDING WORKPEOPLE ETC. Allow for complying with all Government Acts, Orders and Regulations in connection with the employment of Labour and other matters related to the execution of the works. In particular the Contractor's attention is drawn to the provisions of the Factory Act 1950 and his tender must include for all costs arising or resulting from compliance with any Act, Order or Regulation relating to Insurances, pensions and holidays for workpeople or so the safety, health and welfare of the workpeople. The Contractor must make himself fully acquainted with current Acts and Regulations, including Police Regulations regarding the movement, housing, security and control of labour, labour camps, passes for transport, etc. It is most important that the Contractor, before tendering, shall obtain from the relevant Authority the fullest information regarding all such regulations and/or restrictions which may affect the information regarding all such regulations and/or restrictions which may affect the organisation of the works, supply and control of labour, etc., and allow accordingly in his tender.</p> <p>No claim in respect of want of knowledge in this connection will be entertained.</p>	
D	<p>REMOVAL OF RUBBISH ETC. Removal of rubbish and debris from the Buildings and site as it accumulates and at the completion of the works and remove all plant, scaffolding and unused materials at completion.</p>	
C	<p>BLASTING OPERATIONS Blasting will only be allowed with the express permission of the PROJECT MANAGER in writing. All blasting operations shall be carried out at the Contractor's sole risk and cost in accordance with any Government regulations in force for the time being, and any special regulations laid down by the PROJECT MANAGER governing the use and storage of explosives.</p>	
D	<p>SIGNBOARD Allow for providing, erecting, maintaining throughout the course of the Contract and afterwards clearing away a signboard as designed, specified and approved by the Project Manager.</p>	
	Total carried to summary	

ITEM	DESCRIPTION	AMOUNT (Kshs.)
	<u>SUMMARY</u>	
	Brought Forward From Page GP/1	
	Brought Forward From Page GP/2	
	Brought Forward From Page GP/3	
	Brought Forward From Page GP/4	
	Brought Forward From Page GP/5	
	Brought Forward From Page GP/6	
	Brought Forward From Page GP/7	
	Brought Forward From Page GP/8	
	Brought Forward From Page GP/9	
	Brought Forward From Page GP/10	
	Brought Forward From Page GP/11	
	Brought Forward From Page GP/12	
	TOTAL CARRIED TO GRAND SUMMARY	

**BUILDERS WORK
GROUND FLOOR**

ITEM	DESCRIPTION	QTY	UNIT	RATE	AMOUNT
	<u>ELEMENT NO. 1</u>				
	<u>SUBSTRUCTURE</u>				
	<u>(ALL PROVISIONAL)</u>				
	<u>Tenderer's to note Working space is not allowed for when pricing excavations</u>				
	<u>Excavations</u>				
A	Clear site off all vegetation including small trees, scrubs and bushes and store away from site as directed by the Project Manager.	800	SM		
B	Excavate over site to reduce levels commencing from existing ground level not exceeding 1.50m deep; average depth 300mm	800	SM		
C	Bulk excavation not exceeding 1.50m deep starting from reduced level	1200	CM		
D	Excavate foundation trench starting from the reduced levels not exceeding 1.50m deep	306	SM		
E	Excavate for column bases not exceeding 1.50m from reduced level	342	CM		
F	Allow for keeping the excavation free from general water including spring and running water by bailing, pumping or otherwise	1	ITEM		
G	Allow for planking, strutting and shoring to sides of all excavations; keep excavations free from all fallen materials	1	ITEM		
H	Return, ram selected excavated materials	1650	CM		
J	Load and cart away excess excavated materials as directed by the Project Manager	438	CM		
	Carried to collection				
	<u>Selected imported material</u>				

ITEM	DESCRIPTION	QTY	UNIT	RATE	AMOUNT
A	Filling in making up levels under floors, spread levelled, well rammed and consolidated in 150mm layers.	400	CM		
B	300mm hardcore bed well compacted and blinded with 50mm thick murrum, quarry dust or sand finished to receive damp proof membrane (measured separately); well watered and compacted in 300 mm thick (max) layers <u>Tender rate shall allow within the unit rate build up for treating vertical sides of foundation trenches, column base pits and around building plinth as per manufacturers printed instructions, quantity indicated herein is measured flat overall on net ground floor surface beds, provide ten year guarantee</u>	240	CM		
C	Premise 200 SC Chemical anti termite treatment manufactured by Bayer Environmental Science or other equal and approved, applied by an approved specialist under a ten year guarantee to surfaces of hardcore, etc. <u>DPM</u>	800	SM		
D	1000 Gauge approved polythene sheeting as damp proof membrane laid on blinded hardcore (measured separately) with welted laPP (measured net - no allowance made for laPP). <u>Concrete work</u> <u>Plain concrete 1:3:6 (class Q)</u>	800	SM		
E	50mm Plain concrete (1:3:6) blinding under strip foundation.	234	SM		
F	Ditto but to column bases. <u>Vibrated reinforced concrete 1:1.5:3 (class 25) waterproofed with and including 'Sika 1' or other equal and approved waterproofing compound in strict accordance with the manufacturer's instructions.</u>	240	SM		
G	Strip Foundation	71	CM		
H	Column bases	312	CM		
J	Columns	26	CM		
K	Steps	5	CM		
	Carried to collection				

ITEM	DESCRIPTION	QTY	UNIT	RATE	AMOUNT
A	150mm Bed laid on damp proof membrane (measured separately) in bays not exceeding 35 square metres including formwork to edge of bays . <u>Reinforcement</u> <u>Square twisted high tensile bars to B.S 4461</u>	800	SM		
B	Assorted size 8-25mm diameter <u>Fabric Mesh</u>	49680	KG		
C	Fabric mesh ref: A142 weighing 2.22Kg per square metre in ground floor slab. <u>Sawn formwork</u>	800	SM		
D	Sides of strip foundation.	144	SM		
E	Sides of column bases.	432	SM		
F	Sides of columns.	143	SM		
G	Edge of slab 150 - 225mm high. <u>Approved natural quarry stone; roughly squared; bedding, jointing and pointing in cement sand mortar (1:3) laid in regular courses; reinforced with 20 gauge x 25mm wide hoop iron reinforcement and column wall ties in every alternate course</u>	200	LM		
H	200mm Load bearing (7 N/mm ²) walling. <u>Plinth Finishes</u>	578	SM		
J	12mm thick cement/sand (1:4) render to plinth	100	SM		
K	Prepare and apply three coats black Bituminous paint on rendered plinth	100	SM		
	Carried to collection				

ITEM	DESCRIPTION	QTY	UNIT	RATE	AMOUNT
	<p style="text-align: center;"><u>COLLECTION</u></p> <p>Brought forward from Page KB/1</p> <p>Brought forward from Page KB/2</p> <p>Brought forward from Page KB/3</p>				
	<u>SUBSTRUCTURE CARRIED TO SUMMARY</u>				
	<p><u>ELEMENT NO. 1</u></p> <p><u>SUPERSTRUCTURE CONCRETE WORK</u></p>				

ITEM	DESCRIPTION	QTY	UNIT	RATE	AMOUNT
	<u>Vibrated reinforced concrete class 25 (1:1.5:3) aggregates as described in:-</u>				
A	Beams	51	CM		
B	Columns	22	CM		
C	Staircase	14	CM		
D	150mm thick suspended slab	800	SM		
E	200mm lift shaft wall	40	SM		
	<u>Reinforcement</u>				
	<u>Square twisted high tensile bars to B.S. 4461</u>				
F	Assorted size 8-25mm diameter	28110	KG		
	<u>Sawn formwork to:</u>				
G	Sides and soffits of beams	493	SM		
H	Sides of columns	261	SM		
J	Soffit of suspended slab	800	SM		
K	Sides of lift shaft	80	SM		
L	Soffits of slopping staircase	23	SM		
M	Soffits of landings	15	SM		
N	Edges of risers; 150mm high	45	LM		
P	Sloping staircase string 300mm extreme girth and cut to profile of steps	19	LM		
	<u>SUPERSTRUCTURE CONCRETE WORK</u>				
	<u>CARRIED TO SUMMARY</u>				

ITEM	DESCRIPTION	QTY	UNIT	RATE	AMOUNT
	<u>ELEMENT NO.3</u>				
	<u>SUPERSTRUCTURE WALLING</u>				
	<u>Machine cut natural stone walling in 200mm course heights, bedded and jointed in cement sand mortar (1:3), reinforced with 20 gauge x 25mm wide hoop iron reinforcement and column wall ties in every alternate course. Uneven stone block sizes shall not be acceptable</u>				
A	200mm Load bearing (7 N/mm2) External walling.	504	SM		
B	200mm thick internally	476	SM		
C	150mm ditto	70	SM		
	<u>Pluvex No. 1 or other equal and approved horizontal bitumen damp proof course to B.S. 743 (measured net - no allowance made for lap).</u>				
D	200mm Wide under walling.	350	LM		
E	150mm ditto	25	LM		
	SUPERSTRUCTURE WALLING CARRIED TO SUMMARY				

ITEM	DESCRIPTION	QTY	UNIT	RATE	AMOUNT
	<u>ELEMENT NO.4</u>				
	<u>DOORS</u>				
	<u>Mild Steel door</u>				
	<u>Supply, assemble and fix the following purpose made mild steel doors constructed from 100 x 50 x 3 mm SHS frame obtained from an approved manufacturer and primed with red oxide before delivery; complete with all necessary ironmongery including building lugs to jambs, plugging and screwing to stonework and bedding frames in waterproof cement mortar; pointing in approved mastic externally; oiling easing and adjusting.</u>				
A	1500 x 2850mm high door	8	NO		
	<u>Pannelled door</u>				
	<u>50mm thick mahogany pannelled door in , comprising 150 x 50mm top and bottom rails infilled with 50mm thick solid moulded timber panels with moulded beading around panels; edges bevelled and grooved into frames; all framed, clamped and grooved together to Architects details</u>				
B	45 x 1500 x 2400mm high door	7	NO		
C	45 x 900 x 2400mm ditto	5	NO		
	<u>Flush doors</u>				
	<u>50mm thick overall size 900 x 2100mm high solid core flush single leaf door faced both sides with 3mm thick mahogany veneered plywood and hard-wood lipped all round with 10mm thick wrot magogany timber to schedule including all iron mongery</u>				
D		12	NO		
E	50mm thick overall size 1500 x 2100mm double leaf	4	NO		
	<u>Folding door</u>				
	<u>18mm thick medium density fibre board folding door, all edges ripped inclusive of bottom and top rolling channels, all iron mongery to Project Manager details</u>				
F	6500 x 2800mm high	2	SM		
	<u>Glazing</u>				
G	5mm Thick clear sheet glass panes over 0.1 but not exceeding 0.5 square meters; fixing with putty	7	SM		
	Carried to collection				
	<u>Frames & finishings</u>				

ITEM	DESCRIPTION	QTY	UNIT	RATE	AMOUNT
	<u>In wrot cypress</u>				
A	15mm quadrant beading with one labour	195	LM		
B	45 x 20mm architrave with one labour	195	LM		
C	200 x 50mm frame with six labours plugged	195	LM		
D	Ditto but transome	41	LM		
	<u>Painting</u>				
	<u>Prepare and apply three coats of clear polyurethane lacquer on wood:-</u>				
E	General surfaces	190	SM		
F	Ditto not exceeding 100mm girth internally	390	LM		
G	Ditto exceeding 100mm but not exceeding 200mm girth internally	236	LM		
	<u>Iron mongery</u>				
	<u>Supply and fix the following to UNION catalogue or other equal and approved</u>				
H	100mm heavy duty brass butt hinges	70.5	PRS		
J	100mm double swing hinges	12.0	PRS		
K	3- lever mortice sash lock cat. No. 2237 complete with aluminium level furniture	18	NO		
L	38mm diameter, 59mm deep rubber door stop cat. No. 8400 including 32mm deep iron lug plugged to floor	18	NO		
M	150 x 25 x 6mm thick mild steel door fixing cramp one end bent and twice screwed to frame and the other fanged and built into wall	306	NO		
N	150 x 100mm "male" or "female" symbol plate cat No MSC/FSC-75	6	NO		
P	Delayed action non-reversible overhead door closer as "GLD" cat. No. 7724H	3	NO		
Q	Indicator vacant/engaged bolts	16	NO		
R	150mm D pull handle	32	NO		
	Carried to collection				

ITEM	DESCRIPTION	QTY	UNIT	RATE	AMOUNT
	<u>COLLECTION</u>				
	Brought forward from page KB/7				
	Brought forward from KB/8				
	DOORS CARRIED TO SUMMARY				

ITEM	DESCRIPTION	QTY	UNIT	RATE	AMOUNT
	<u>ELEMENT NO. 5</u>				
	<u>WINDOWS</u>				
	<u>Mild Steel Windows</u>				
	<u>Supply, assemble and fix the following purpose made windows constructed from approved standard 25mm 'Z' and 'T' steel sections primed with approved red oxide primer before delivery on site complete with welded burglar-proof in 12 mm thick mild steel grille, 16 gauge sheet metal hood 50mm high x 50mm projection to full width of window, approved brass fasteners and stays, steel hinges, catches, handles available from Kensmetal or other equal and approved, lugs cast on and built into jambs and including plugging and screwing as necessary and pointing around frame in approved mastic. The windows shall conform in every respect with drawings bracketed after every item description and to the entire satisfaction of the Architect. All windows to have permanent ventilations including mosquito gauze and all necessary paintwork</u>				
A	Window overall size 3000 x 1500mm high	30	NO		
B	Window overall size 1000 x 1800mm high	8	NO		
C	Window overall size 900 x 600mm high	24	NO		
	<u>Glazing</u>				
D	5mm Thick clear sheet glass panes over 0.1 but not exceeding 0.5 square meters; fixing with putty	150	SM		
E	Ditto but obscure	14	SM		
	<u>Window Cill</u>				
F	250 x 75mm Precast concrete (class 20) sunk, weathered and throated cill cast in convenient lengths, reinforced as necessary for handling, bedded, jointed and pointed in gauged mortar and finished fair on all exposed faces.	130	LM		
G	Horizontal bitumen dampproof course to B.S. 743 250mm wide under window cill (measured net - no allowance made for lap).	130	LM		
	WINDOWS CARRIED TO SUMMARY				

ITEM	DESCRIPTION	QTY	UNIT	RATE	AMOUNT
	<u>ELEMENT NO. 6</u>				
	<u>FINISHES</u>				
	<u>FLOOR FINISHES</u>				
	<u>Cement and sand (1:3) in</u>				
A	30mm thick cement and sand (1:3) screed paving including backing, trowelled to receive tiles (m.s)	710	SM		
B	Ditto to receive non-slip tiles	90	SM		
	<u>Approved polished tiles laid on screed (m/s)</u>				
C	400 x 400 x 10mm thick tiles	380	SM		
D	300 x 300 x 10mm ditto	330	SM		
E	Ditto;100 x 10mm thick skirting	340	LM		
	<u>Approved non-slip tiles laid on screed (m/s)</u>				
F	Approved size wall tiles	90	SM		
	<u>WALL FINISHES</u>				
	<u>Cement/sand (1:3) in:</u>				
G	12mm thick plaster to walls trowelled smooth internally	1556	SM		
H	Ditto but finished to receive tiles	380	SM		
J	12mm thick render to beams and columns trowelled rough externally to receive paint(m/s)	320	SM		
K	16mm thick rod key point externally	540	SM		
	<u>Approved coloured tiles in approved pattern</u>				
L	12mm thick tiles	380	SM		
	<u>Prepare and apply one undercoat and two finishing coats of "Crown" or other equal and approved plastic emulsion paint on</u>				
M	Plastered wall internally	1556	SM		
N	Plastered beams and columns externally	320	SM		
	Carried to collection				

ITEM	DESCRIPTION	QTY	UNIT	RATE	AMOUNT
	<u>CEILING FINISHES</u>				
	<u>Cement/sand (1:3) in:</u>				
A	12mm thick plaster to soffit trowelled smooth	760	SM		
B	Ditto to beams	294	SM		
	<u>Prepare and apply one undercoat and two finishing coats of "Crown" or other equal and approved plastic emulsion paint on</u>				
C	Ceiling surfaces	760	SM		
D	Beam surfaces	294	SM		
	<u>STAIRCASE FINISHES</u>				
	<u>Cement/sand (1:3) to receive tiles in</u>				
E	40mm thick screed to landing	15	SM		
F	Ditto to 300mm wide treads	45	LM		
G	Ditto to 150mm high risers	45	LM		
H	Ditto to 200-300mm wide edge of sloping staircase	17	LM		
J	Ditto slopping soffites	15	SM		
K	Soffites of suspended slab	15	SM		
	<u>Approved polished tiles in:</u>				
L	10mm thick tiles to landing	15	SM		
M	Ditto to 300mm wide treads	45	LM		
N	Ditto to 150mm high risers	45	LM		
P	Ditto to 200-300mm wide edge of sloping staircase	17	LM		
	Carried to collection				

ITEM	DESCRIPTION	QTY	UNIT	RATE	AMOUNT
A	<u>Balustrades</u> <u>Mild steel sections cut and welded together as directed and primed with red lead oxide after fixing</u> 900mm high mild steel balustrades comprising 50 x 50mm RHS handrail ; 25 x 25 x 3mm thick RHS balusters at 500mm centres each 900mm long the top end of bar welded to the flat bar and the bottom cast and built into concrete floor bed ; 25 x 3mm flat bar side rails and 16mm square solid bars x 600mm long wrought iron lathed mini balusters green/gold painted infilled and welded between the two side rails at 100mm centres and including all necessary paint works	16	LM		
	Carried to collection				
	<u>COLLECTION</u> Brought forward from Page KB/11 Brought forward from Page KB/12 Brought forward from Above				
	FINISHES CARRIED TO SUMMARY				

GROUND FLOOR SUMMARY

<u>ELEMENT NO.</u>	<u>DESCRIPTION</u>	<u>PAGE NO.</u>
1	SUBSTRUCTURE	KB/4
2	SUPERSTRUCTURE CONCRETE WORK	KB/5
3	SUPERSTRUCTURE WALLING	KB/6
4	DOORS	KB/9
5	WINDOWS	KB/10
6	FINISHES	KB/13

TOTAL BUILDERS WORK CARRIED TO GRAND SUMMARY

FIRST FLOOR

ITEM	DESCRIPTION	QTY	UNIT	RATE	AMOUNT
	<u>ELEMENT NO. 1</u>				
	<u>SUPERSTRUCTURE CONCRETE WORK</u>				
	<u>Vibrated reinforced concrete class 25 (1:1.5:3) aggregates as described in:-</u>				
A	Beams	51	CM		
B	Columns	22	CM		
C	Staircase	14	CM		
D	150mm thick suspended slab	800	SM		
E	200mm lift shaft wall	40	SM		
	<u>Reinforcement</u>				
	<u>Square twisted high tensile bars to B.S. 4461</u>				
F	Assorted size 8-25mm diameter	28110	KG		
	<u>Sawn formwork to:</u>				
G	Sides and soffits of beams	493	SM		
H	Sides of columns	248	SM		
J	Soffit of suspended slab	800	SM		
K	Sides of lift shaft	80	SM		
L	Soffits of sloping staircase	23	SM		
M	Soffits of landings	15	SM		
N	Edges of risers; 150mm high	45	LM		
P	Sloping staircase string 300mm extreme girth and cut to profile of steps	19	LM		
	<u>SUPERSTRUCTURE CONCRETE WORK</u>				
	<u>CARRIED TO SUMMARY</u>				

ITEM	DESCRIPTION	QTY	UNIT	RATE	AMOUNT
	<u>ELEMENT NO.2</u>				
	<u>SUPERSTRUCTURE WALLING</u>				
	<u>Machine cut natural stone walling in 200mm course heights, bedded and jointed in cement sand mortar (1:3), reinforced with 20 gauge x 25mm wide hoop iron reinforcement and column wall ties in every alternate course. Uneven stone block sizes shall not be acceptable</u>				
A	200mm Load bearing (7 N/mm ²) External walling.	504	SM		
B	200mm thick internally	476	SM		
C	150mm ditto	70	SM		
	<u>Pluvex No. 1 or other equal and approved horizontal bitumen damp proof course to B.S. 743 (measured net - no allowance made for lap).</u>				
D	200mm Wide under walling.	350	LM		
E	150mm ditto	25	LM		
	SUPERSTRUCTURE WALLING CARRIED TO SUMMARY				

ITEM	DESCRIPTION	QTY	UNIT	RATE	AMOUNT
	<u>ELEMENT NO.3</u>				
	<u>DOORS</u>				
	<u>Mild Steel door</u>				
	<u>Supply, assemble and fix the following purpose made mild steel doors constructed from 100 x 50 x 3 mm SHS frame obtained from an approved manufacturer and primed with red oxide before delivery; complete with all necessary ironmongery including building lugs to jambs, plugging and screwing to stonework and bedding frames in waterproof cement mortar; pointing in approved mastic externally; oiling easing and adjusting.</u>				
A	1500 x 2850mm high door	8	NO		
	<u>Pannelled door</u>				
	<u>50mm thick mahogany pannelled door in , comprising 150 x 50mm top and bottom rails infilled with 50mm thick solid moulded timber panels with moulded beading around panels; edges bevelled and grooved into frames; all framed, clamped and grooved together to Architects details</u>				
B	45 x 1500 x 2400mm high door	8	NO		
C	45 x 900 x 2400mm ditto	5	NO		
	<u>Flush doors</u>				
	<u>50mm thick overall size 900 x 2100mm high solid core flush single leaf door faced both sides with 3mm thick mahogany veneered plywood and hard-wood lipped all round with 10mm thick wrot magogany timber to schedule including all iron mongery</u>				
D		12	NO		
E	50mm thick overall size 1500 x 2100mm double leaf	4	NO		
	<u>Folding door</u>				
	<u>18mm thick medium density fibre board folding door, all edges ripped inclusive of bottom and top rolling channels, all iron mongery to Project Manager details</u>				
F	6500 x 2800mm high	2	SM		
	<u>Glazing</u>				
G	5mm Thick clear sheet glass panes over 0.1 but not exceeding 0.5 square meters; fixing with putty	7	SM		
	Carried to collection				
	Frames & finishings				

ITEM	DESCRIPTION	QTY	UNIT	RATE	AMOUNT
	<u>In wrot cypress</u>				
A	15mm quadrant beading with one labour	203	LM		
B	45 x 20mm architrave with one labour	203	LM		
C	200 x 50mm frame with six labours plugged	203	LM		
D	Ditto but transome	44	LM		
	<u>Painting</u>				
	<u>Prepare and apply three coats of clear polyurethane lacquer on wood:-</u>				
E	General surfaces	196	SM		
F	Ditto not exceeding 100mm girth internally	406	LM		
G	Ditto exceeding 100mm but not exceeding 200mm girth internally	247	LM		
	<u>Iron mongery</u>				
	<u>Supply and fix the following to UNION catalogue or other equal and approved</u>				
H	100mm heavy duty brass butt hinges	72.0	PRS		
J	100mm double swing hinges	12.0	PRS		
K	3- lever mortice sash lock cat. No. 2237 complete with aluminium level furniture	19	NO		
L	38mm diameter, 59mm deep rubber door stop cat. No. 8400 including 32mm deep iron lug plugged to floor	19	NO		
M	150 x 25 x 6mm thick mild steel door fixing cramp one end bent and twice screwed to frame and the other fanged and built into wall	312	NO		
N	150 x 100mm "male" or "female" symbol plate cat No MSC/FSC-75	6	NO		
P	Delayed action non-reversible overhead door closer as "GLD" cat. No. 7724H	3	NO		
Q	Indicator vacant/engaged bolts	16	NO		
R	150mm D pull handle	32	NO		
	Carried to collection				

ITEM	DESCRIPTION	QTY	UNIT	RATE	AMOUNT
	<u>COLLECTION</u>				
	Brought forward from page IB/3				
	Brought forward from page IB/4				
	DOORS CARRIED TO SUMMARY				

ITEM	DESCRIPTION	QTY	UNIT	RATE	AMOUNT
	<u>ELEMENT NO. 4</u>				
	<u>WINDOWS</u>				
	<u>Mild Steel Windows</u>				
	<u>Supply, assemble and fix the following purpose made windows constructed from approved standard 25mm 'Z' and 'T' steel sections primed with approved red oxide primer before delivery on site complete with welded burglar-proof in 12 mm thick mild steel grille, 16 gauge sheet metal hood 50mm high x 50mm projection to full width of window, approved brass fasteners and stays, steel hinges, catches, handles available from Kensmetal or other equal and approved, lugs cast on and built into jambs and including plugging and screwing as necessary and pointing around frame in approved mastic. The windows shall conform in every respect with drawings bracketed after every item description and to the entire satisfaction of the Architect. All windows to have permanent ventilations including mosquito gauze and all necessary paintwork</u>				
A	Window overall size 3000 x 1500mm high	30	NO		
B	Window overall size 1000 x 1800mm high	8	NO		
C	Window overall size 900 x 600mm high	24	NO		
	<u>Glazing</u>				
D	5mm Thick clear sheet glass panes over 0.1 but not exceeding 0.5 square meters; fixing with putty	150	SM		
E	Ditto but obscure	14	SM		
	<u>Window Cill</u>				
F	250 x 75mm Precast concrete (class 20) sunk, weathered and throated cill cast in convenient lengths, reinforced as necessary for handling, bedded, jointed and pointed in gauged mortar and finished fair on all exposed faces.	130	LM		
G	Horizontal bitumen dampproof course to B.S. 743 250mm wide under window cill (measured net - no allowance made for lap).	130	LM		
	WINDOWS CARRIED TO SUMMARY				

ITEM	DESCRIPTION	QTY	UNIT	RATE	AMOUNT
	<u>ELEMENT NO. 5</u>				
	<u>FINISHES</u>				
	<u>FLOOR FINISHES</u>				
	<u>Cement and sand (1:3) in</u>				
A	30mm thick cement and sand (1:3) screed paving including backing, trowelled to receive tiles (m.s)	710	SM		
B	Ditto to receive non-slip tiles	90	SM		
C	30mm thick cement and sand (1:3) water proofing screed trowelled smooth	800	SM		
	<u>Approved polished tiles laid on screed (m/s)</u>				
D	400 x 400 x 10mm thick tiles	380	SM		
E	300 x 300 x 10mm ditto	330	SM		
F	Ditto;100 x 10mm thick skirting	340	LM		
	<u>Approved non-slip tiles laid on screed (m/s)</u>				
G	Approved size wall tiles	90	SM		
	<u>WALL FINISHES</u>				
	<u>Cement/sand (1:3) in:</u>				
H	12mm thick plaster to walls trowelled smooth internally	1556	SM		
J	Ditto but finished to receive tiles	380	SM		
K	12mm thick render to beams and columns trowelled rough externally to receive paint(m/s)	320	SM		
L	16mm thick rod key point externally	540	SM		
	<u>Approved coloured tiles in approved pattern</u>				
M	12mm thick tiles	380	SM		
	<u>Prepare and apply one undercoat and two finishing coats of "Crown" or other equal and approved plastic emulsion paint on</u>				
N	Plastered wall internally	1556	SM		
P	Plastered beams and columns externally	320	SM		
	Carried to collection				

ITEM	DESCRIPTION	QTY	UNIT	RATE	AMOUNT
	<u>CEILING FINISHES</u>				
	<u>Cement/sand (1:3) in:</u>				
A	12mm thick plaster to soffit trowelled smooth	760	SM		
B	Ditto to beams	294	SM		
	<u>Prepare and apply one undercoat and two finishing coats of "Crown" or other equal and approved plastic emulsion paint on</u>				
C	Ceiling surfaces	760	SM		
D	Beam surfaces	294	SM		
	<u>STAIRCASE FINISHES</u>				
	<u>Cement/sand (1:3) to receive tiles in</u>				
E	40mm thick screed to landing	15	SM		
F	Ditto to 300mm wide treads	45	LM		
G	Ditto to 150mm high risers	45	LM		
H	Ditto to 200-300mm wide edge of sloping staircase	17	LM		
J	Ditto slopping soffites	15	SM		
K	Soffites of suspended slab	15	SM		
	<u>Approved polished tiles in:</u>				
L	10mm thick tiles to landing	15	SM		
M	Ditto to 300mm wide treads	45	LM		
N	Ditto to 150mm high risers	45	LM		
P	Ditto to 200-300mm wide edge of sloping staircase	17	LM		
	Carried to collection				

ITEM	DESCRIPTION	QTY	UNIT	RATE	AMOUNT
A	<p><u>Balustrades</u></p> <p><u>Mild steel sections cut and welded together as directed and primed with red lead oxide after fixing</u></p> <p>900mm high mild steel balustrades comprising 50 x 50mm RHS handrail ; 25 x 25 x 3mm thick RHS balusters at 500mm centres each 900mm long the top end of bar welded to the flat bar and the bottom cast and built into concrete floor bed ; 25 x 3mm flat bar side rails and 16mm square solid bars x 600mm long wrought iron lathed mini balusters green/gold painted infilled and welded between the two side rails at 100mm centres and including all necessary paint works</p>	16	LM		
	Carried to collection				
	<p><u>COLLECTION</u></p> <p>Brought forward from Page IB/7</p> <p>Brought forward from Page IB/8</p> <p>Brought forward from Above</p>				
	FINISHES CARRIED TO SUMMARY				

FIRST FLOOR SUMMARY**ELEMENT NO.****DESCRIPTION****PAGE NO.**

1	SUPERSTRUCTURE CONCRETE WORK	IB/1
2	SUPERSTRUCTURE WALLING	IB/2
3	DOORS	IB/5
4	WINDOWS	IB/6
5	FINISHES	IB/9

TOTAL BUILDERS WORK CARRIED TO GRAND SUMMARY

			SHS
<u>BUILDERS WORK SUMMARY</u>			
<u>ELEMENT NO.</u>	<u>DESCRIPTION</u>	<u>PAGE NO.</u>	
1	GROUND FLOOR	GFS/1	
2	FIRST FLOOR	FFS/1	
TOTAL BUILDERS WORK CARRIED TO GRAND SUMMARY			

ELECTRICAL WORKS

ITEM	DESCRIPTION	UNIT	QTY	RATE	KSH
	Constructiuon of a Tution Block Ground floor				
A	LIGHTING Supply, Install, test and commission the , following items				
	Lighting points wired in 3 x 1.5mm ² PVC/SC CU cables drawn in 20mmØ surface mounted HG/PVC conduits complete with all necessary accessories but excluding switches for:-				
1.01	i) One way switching	106	No.		
	ii) Two way switching with intermediate	27	No.		
	iii) unswitched	2	No.		
	SWITCHES				
1.02	10A, moulded ivory white architrave switch plates as MK Range or approved equivalent as follows:-				
	i) One gang one way	17	No.		
	ii) Two gang two way	2	No.		
	iii) two gang one way	2	No.		
	iv) intermediate	1	No.		
	LIGHTING FITTINGS				
1.03	Lighting fittings complete with lamps of appropriate wattage and colour rendering and fixing materials as follows:-				
	i) Type E	2	No.		
	ii) Type Exit	2	No.		
	iii) Type G	61	No.		
	iv) Type F	3	No.		
	v) Type D	35	No.		
	vi) Type C	17	No.		
	vii) Type A	15	No.		
	SOCKET OUTLET&OTHER POWER POINTS				
1.04	Raw power socket outlet power points comprising wiring in 3 x 2.5mm ² PVC/SC CU cables drawn in 25mmØ concealed HG PVC conduits/trunking including all conduit accessories but excluding plates	66	No.		
1.05	13A moulded switched socket outlet plates as MK or approved equivalent as follows: ii) Twin switched	66	No.		
1.06	Toilet extract power points comprising wiring in 3 x 2.5mm ² PVC/SC/CU cables drawn in 25mmØ concealed HG PVC conduits	4	No.		
	Total carried to collection				

ITEM	DESCRIPTION	UNIT	QTY	RATE	KSH
	<u>OTHER POWER POINTS</u>				
1.07	20A, DP control switch with neon light and cord outlet for item above as MK or approved equivalent	4	No.		
1.08	Kitchen extract power points comprising wiring in 3 x 2.5mm ² PVC/SC/CU cables drawn in 25mmØ concealed HG PVC conduits	0	No.		
1.09	20A, DP control switch with neon light and cord outlet for item above as MK or approved equivalent	0	No.		
1.10	Hand drier power points comprising wiring in 3 x 4mm ² PVC/SC/CU cables drawn in 25mmØ HG/PVC conduits complete with all necessary accessories	6	No.		
1.11	20A, DP control switch with neon light and cord outlet for item above as MK or approved equivalent	6	No.		
1.12	Cooker Unit power points comprising wiring in 3x6mm ² PVC/SC/CU cables drawn in 32mm diameter HG/PVC conduit complete with all necessary accessories	1	No.		
1.14	45A Cooker control unit complete with 13A socket outlet and pilot lamps as MK or approved equivalent.	1	No.		
	DATA/TELEPHONE/TELEVISION & ACCESS CONTROL				
1.15	250 X 50mm - 3 compartment, gauge 16 sheet Deep Powder coated metal trunking complete with bends, outlet plates and other necessary accessories As Manufactured by Power	70	LM		
1.16	Data/Telephone outlet points comprising 25mmØ concealed HG PVC conduits complete with draw wire.	46	No.		
1.17	Television cord outlet points comprising 25mmØ HG PVC conduits complete with T.V co-axial socket outlet as M.K or Approved Equivalent	1	No.		
1.18	250x250x75mm recessed galvanised sheet steel draw boxes complete with powder coated cover and all other necessary accessories	4	No		
1.19	C.C.T.V points comprising draw wire in concealed 20mm Ø HG PVC Conduits all emanating from the server room/security office	17	No.		
1.20	2x50mmØ PVC HG conduit linking the Draw Boxes	150	LM		
	Total carried to collection				

ITEM	DESCRIPTION	UNIT	QTY	RATE	KSH
	FIRE ALARM SYSTEM				
1.21	Fire Alarm points completely wired in 3x2.5mm ² heat resistant cables drawn in 20mmØ concealed HG PVC conduits including all accessories.	16	No.		
1.22	Addressable Photoelectric Smoke Detector as Menvier or Approved Equivalent	13	No.		
1.23	Addressable Manual Fire Alarm 'Break Glass' call points as	2	No.		
1.24	Addressable Electronic Fire Alarm sounder complete with	1	No.		
	POWER DISTRIBUTION				
	Supply, Install, Test and Commission the following Distribution Boards as Eaton or approved equivalent				
	RAW POWER DISTRIBUTION BOARDS				
1.25	125A, 6-Way, TPN surface/flush mounted DB/Consumer Unit as EATON or approved equivalent	2	No.		
1.26	SP Miniature circuit breakers for the distribution boards above				
	i) 10A SP MCB	7	No.		
	ii) 20A SP MCB	10	No.		
	iii) 32A SP MCB	6	No.		
	iv) TP blanking plates	4	No.		
	SUB-MAINS & FEEDER CABLES				
1.27	16 mm ² 4-C PVC/SWA/PVC copper cable to DB above c/w appropriate cable lugs	40	Lm		
	i) Cable glands for above cable	4	No.		
1.28	150x75mm, 14SWG cable tray c/w mounting row bolts and all other necessary accessories	20	Lm		
1.29	300x300x75mm recessed galvanised sheet steel draw boxes compete with powder coated cover and all other necessary	2	No.		
1.30	Allow for labelling the distribution boards under this section including all the incoming and outgoing circuits as per the	1	Item		
	Total carried to collection				

ITEM	DESCRIPTION	UNIT	QTY	RATE	KSH
	COLLECTION PAGE				
A	Total brought forward from page elc 1				
B	Total brought forward from page elc 2				
C	Total brought forward from page elc 3 above				
	TOTAL FOR GROUND FLOOR CARRIED TO SUMMARY PAGE				

ITEM	DESCRIPTION	UNIT	QTY	RATE	KSH
	<p>POWER DISTRIBUTION</p> <p>CONTROL SWITCH GEAR AND SUBMAINS CABLING.</p> <p>POWER DISTRIBUTION PANEL, LV BOARD:</p> <p>10-way modular type, free standing power distribution panel board for floor mounting with both rear and front access panels, cable manager compartments, metal clad 14SWG, 415 mains L.V</p> <p>2.00 Switch Board manufactured to BS EN60 439-1, form 2b separation and fully wired for one incoming MCCB and 10No. TP outgoing feeders as described here below with the following and all the other necessary accessories:</p> <ul style="list-style-type: none"> i) 350A TPN busbars ii) 300A TPN busbars (essential busbars) iii) 300 Amps 4 pole Automatic Transfer Switching (ATS) system as Merlin Gerin "BA" or equal and approved. iv) Voltmeter/ Ammeters meters complete with associated current transformers; v) All necessary interconnecting cables; <p>a) Incomer Adjustable TPN MCCB</p> <ul style="list-style-type: none"> i) 300A TP MCCB main Incomer, adjustable and with trip coil as Crabtree or Equal and approved for above board <p>b) Outgoing adjustable TPN MCCB</p> <ul style="list-style-type: none"> i) 8 x 80A TPN MCCB ii) 2 x Spare spaces <p>2.01 Allow for labelling the switch board under this section including all the incoming and outgoing circuits as per the specifications to</p> <p>2.02 Firemans switch including interwiring with the main incomer MCCB</p>	1	Item		
	Total carried to collection				

ITEM	DESCRIPTION	UNIT	QTY	RATE	KSH
2.03	Earthing arrangements for the LV switchboard comprising 25x3mm copper tape lead, 1800mm long x 15mm diameter copper earth electrode as Furse or approved equivalent c/w driving stud and tape to rod clamp, 300mm x 300mm x 300mm deep concrete inspection earth pit with removable waterproof cover, 900mm x 900mm copper earth mat soil conditioning agents comprising	1	Item		
2.04	70 mm ² 4-C PVC/SWA/PVC copper cable from KPLC Turret to board above c/w appropriate cable lugs	300	Lm		
	i) Cable glands for above cable	2	No.		
2.05	Allow for trenching to a depth of 750mm , back filling of trenches, and laying of "DANGER " cable tiling (for cable running along non-concrete areas), reinstatement and making of good of ground as directed by the Engineer on site	300	Lm		
2.06	Supply and lay the following uPVC ducts at 600mm below ground level across drive ways and concrete areas.				
	a) 2 x 100mm uPVC duct	40	Lm		
	c) 2 x 150mm uPVC duct with concrete surround	20	Lm		
2.07	Construct 600mm x 600mm x 600mm deep concrete telephone manhole complete with cast iron waterproof cover as per technical specifications to Engineer's approval	4	No.		
2.08	Wiring from the LV Board to Lift Distribution Board in 16mm ² 4-C PVC/SWA/PVC copper conductor cables laid in cable tray (measured elsewhere),	30	Lm		
	a) Cable gland a for above cable	2	No.		
2.09	63A TPN isolator, weatherproof IP65 rated, wall mounted, labelled "LIFT POWER SUPPLY" as manufactured by Telemecanique or KATKO.	1	No.		
2.10	150x75mm, 14SWG cable tray c/w mounting row bolts for mounting and all the other necessary accessories	15	Lm		
Total carried to collection					

ITEM	DESCRIPTION	UNIT	QTY	RATE	KSH
2.11	150x75mm, 14SWG cable tray c/w mounting row bolts for mounting and all the other necessary accessories	15	Lm		
AIR CONDITIONING/COLD ROOM OUTDOOR UNIT POWER SUPPLY					
2.12	10 mm ² 4-C PVC/SWA/PVC copper cable to power D.B's c/w appropriate cable lugs for the Outdoor AC unit	30	Lm		
	i) Cable glands for above cable	2	No.		
	ii) 63A TPN Adjustable MCCB for above cable	1	No.		
	iii) 63A TPN metalclad Isolator	1	No.		
2.13	150x75mm, 14SWG cable tray c/w mounting row bolts for mounting and all the other necessary accessories	20	Lm		
COLLECTION PAGE					
A	Total brought forward from page elc 5				
B	Total brought forward from page elc 06				
C	Total brought forward from page elc 07 above				
TOTAL CONTROL SWITCH GEAR AND SUBMAINS CABLING CARRIED TO SUMMARY PAGE					

ITEM	DESCRIPTION	UNIT	QTY	RATE	KSH
	<i>Constructiuon of a Tution Block 1st floor</i>				
	SUPPLY, DELIVER, INSTALL, TEST AND COMMISSION THE FOLLOWING:-				
	LIGHTING POINTS				
	Lighting points wired in 3 x 1.5mm ² PVC/SC CU cables drawn in 20mmØ surface mounted HG/PVC conduits complete with all necessary accessories but excluding switches for:-				
3.01	i) One way switching	89	No.		
	ii) Two way switching with intermediate	41	No.		
	iii) unswitched	2	No.		
	SWITCHES				
3.02	10A, moulded ivory white architrave switch plates as MK Range or approved equivalent as follows:-				
	i) One gang one way	15	No.		
	ii) Two gang one way	1	No.		
	iii) two gang one way	4	No.		
	LIGHTING FITTINGS				
3.03	Lighting fittings complete with lamps of appropriate wattage and colour rendering and fixing materials as follows:-				
	i) Type E	2	No.		
	ii) Type G	55	No.		
	iii) Type F	3	No.		
	iv) Type A	15	No.		
	v) Type C	16	No.		
	vi) Type Exit	2	No.		
	vii) Type D	39	No.		
	SOCKET OUTLET&OTHER POWER POINTS				
3.04	Raw power socket outlet power points comprising wiring in 3 x 2.5mm ² PVC/SC CU cables drawn in 25mmØ concealed HG PVC conduits/trunking including all conduit accessories but excluding plates	79	No.		
3.05	13A moulded switched socket outlet plates as MK or approved equivalent as follows:				
	ii) Twin switched	79	No.		
	Total carried to collection				

ITEM	DESCRIPTION	UNIT	QTY	RATE	KSH
<u>OTHER POWER POINTS</u>					
3.06	Toilet extract power points comprising wiring in 3 x 2.5mm ² PVC/SC/CU cables drawn in 25mmØ concealed HG PVC	4	No.		
3.07	20A, DP control switch with neon light and cord outlet for item above as MK or approved equivalent	4	No.		
3.08	Kitchen extract power points comprising wiring in 3 x 2.5mm ² PVC/SC/CU cables drawn in 25mmØ concealed HG PVC	0	No.		
3.09	20A, DP control switch with neon light and cord outlet for item above as MK or approved equivalent	0	No.		
3.10	Hand drier power points comprising wiring in 3 x 4mm ² PVC/SC/CU cables drawn in 25mmØ HG/PVC conduits complete with all necessary accessories	6	No.		
3.11	20A, DP control switch with neon light and cord outlet for item above as MK or approved equivalent	6	No.		
3.12	Air Conditioning Unit power points comprising wiring in 3 x 4mm ² PVC/SC CU cables drawn in 32mmØ concealed HG PVC conduits	0	No.		
3.13	20A DP control switch with neon light and cord outlet for item above as MK or approved equivalent	0	No.		
DATA/TELEPHONE/TELEVISION & ACCESS CONTROL					
3.14	250 X 50mm - 3 compartment, gauge 16 sheet Deep Powder coated metal trunking complete with bends, outlet plates and other necessary accessories As Manufactured by Power	80	LM		
3.15	Data/Telephone outlet points comprising 25mmØ concealed HG PVC conduits complete with draw wire.	40	No.		
3.16	Television cord outlet points comprising 25mmØ HG PVC conduits complete with T.V co-axial socket outlet as M.K or Approved Equivalent	0	No.		
3.17	250x250x75mm recessed galvanised sheet steel draw boxes compete with powder coated cover and all other necessary accessories	6	No		
Total carried to collection					

ITEM	DESCRIPTION	UNIT	QTY	RATE	KSH
3.18	C.C.T.V points comprising draw wire in concealed 20mm Ø HG PVC Conduits all emanating from the server room/security office	5	No		
3.19	2x50mmØ PVC HG conduit linking the Draw Boxes	100	LM		
FIRE ALARM SYSTEM					
3.20	Fire Alarm points completely wired in 3x2.5mm ² heat resistant cables drawn in 20mmØ concealed HG PVC conduits including all accessories.	11	No.		
3.21	Addressable Photoelectric Smoke Detector as Menvier or Approved Equivalent	8	No.		
3.23	Addressable Manual Fire Alarm 'Break Glass' call points as	2	No.		
3.24	Addressable Electronic Fire Alarm sounder complete with Red	1	No.		
<u>POWER DISTRIBUTION</u>					
Supply, Install, Test and Commission the following Distribution Boards as Eaton or approved equivalent					
RAW POWER DISTRIBUTION BOARDS					
3.25	100A, 6-Way, SPN surface/flush mounted DB/Consumer Unit as EATON or approved equivalent	2	No.		
3.26	SP Miniature circuit breakers for the distribution boards above				
	i) 10A SP MCB	7	No.		
	ii) 20A SP MCB	8	No.		
	iii) 32A SP MCB	8	No.		
	iv) TP blanking plates	4	No.		
SUB-MAINS & FEEDER CABLES					
3.27	16 mm ² 4-C PVC/SWA/PVC copper cable to DB above c/w appropriate cable lugs	50	Lm		
	i) Cable glands for above cable	2	No.		
3.28	150x75mm, 14SWG cable tray c/w mounting row bolts and all other necessary accessories	15	Lm		
3.29	300x300x75mm recessed galvanised sheet steel draw boxes complete with powder coated cover and all other necessary accessories	1	No.		
3.30	Allow for labelling the distribution boards under this section including all the incoming and outgoing circuits as per the specifications	1	Item		
Total carried to collection					

ITEM	DESCRIPTION	UNIT	QTY	RATE	KSH
	COLLECTION PAGE				
A	Total brought forward from page elc 08				
B	Total brought forward from page elc 09				
C	Total brought forward from page elc 10 above				
	TOTAL FOR FIRST FLOORS ELECTRICAL WORKS CARRIED TO SUMMARY PAGE				

ITEM	DESCRIPTION	UNIT	QTY	RATE	KSH
	<u>SUMMARY PAGE</u>				
1.00	TOTAL FOR GROUND FLOOR ELECTRICAL FROM PAGE ELC/4				
2.00	TOTAL FOR CONTROL SWITCH GEAR FROM PAGE ELC/7				
3.00	TOTAL FOR FIRST FLOORS FROM PAGE ELC/11				
	TOTAL FOR ELECTRICAL WORKS CARRIED TO GRAND SUMMARY				

ITEM	DESCRIPTION	UNIT	QTY	RATE	KSH
	<p>SCHEDULE OF LIGHT FITTINGS</p>				
	<p style="text-align: center;">Description</p>				
	<p style="text-align: center;">LIGHTING FITTINGS</p>				
	<p>Light Fittings complete with all accessories and lamps as follows:</p>				
	<p>Type A 1200mm, 1X36W, 6500K 100Lm/W Slim section, 1P 20 LED batten fitting with as PHILIPS Cozy TMS018 C or approved equivalent.</p>				
	<p>Type C 105mm dia. Circular recessed ceiling LED decorative Downlight 9w,4000k, 115lm/W, 50000hrs lamp life, PHILIPS or approved equivalent.</p>				
	<p>Type D 200mm dia. Circular recessed Ceiling LED Downlight 11W, 4000K, 115Lm/W, 50000 hrs Lamp Life, Plastic Housing and Polycarbonate Diffuser with Integral Control Gear as PHILIPS or approved equivalent.</p>				
	<p>Type E 200mm dia.Circular 11W, 4000K, 115Lm/W, 50000 hrs Lamp Life, Surfaced Ceiling Light with Plastic Housing and Polycarbonate Diffuser as PHILIPS for Washrooms.</p>				
	<p>Type Exit Self-contained single sided EXIT Sign for viewing up to 30m distance,maintained operation, 3W, 3 hours emergency duration with LED strip and ISO Exit legends As THORN or approved equivalent.</p>				
	<p>Type F LED Mirror Strip Luminaire 8W, 4000K, 95Lm/W, 50000 hrs Lamp Life Complete with Diffuser cw pull cord as PHILIPS or approved equivalent. or approved equivalent.</p>				
	<p>Type G Standard Recessed 600 X 600mm Panel Light, 41W, 100Lm/W, 6500K LED, 50000 hrs Lamp Life, Steel Housing and Aluminum Rim, Polystyrene Diffuser with Integral Control Gear as PHILIPS or approved equivalent.</p>				

MECHANICAL WORKS

KARUMO TECHNICAL TRAINING INSTITUTE PROPOSED TUTION BLOCK-

SPECIFIC PRELIMINARIES

Item	Description	Qty	Unit	Rate (Kshs)	Cost (Kshs)
A	Samples and Materials Generally clause	1	item		
B	Setting to work and Regulating system clause	1	item		
C	Working Drawings clause	1	item		
D	Record Drawings (As Installed) and Instructions clause	1	item		
E	Maintenance Manual clause	1	item		
F	Allow a Provisional Sum of KShs. 50,000 for tender documentation	1	item		50,000.00
G	Allow a Provisional Sum of KShs. 100,000 for Supervision by Project Engineer	1	item		100,000.00
H	Testing and Inspection – manufactured plant clause	1	item		
I	Testing and Inspection – Installation clauses	1	item		
Total for preliminaries c/f to mechanical works sumary page					

Item	Description	Qty	Unit	Rate (Kshs)	Cost (Kshs)
------	-------------	-----	------	-------------	-------------

GROUND FLOOR-MECHANICAL WORKS BILLS

	<p>SANITARY APPLIANCES</p> <p>Supply, deliver, install, test and commission the following sanitary appliances complete with all the accessories including all connections to the services, waste, jointing to water supply overflows, supports and all plugging and screwing to walls and floors.</p> <p>(i) All sanitary fittings shall be in approved colour. (ii) The Model and Ref No. indicated is only a guide to the type and quality of fittings. (iii) Equivalent and Approved models may be acceptable.</p> <p>Squatting Water Closet (WC)</p> <p>A Squatting water closet suite in vitreous china comprising of water closet bowl with top plate and integral foot threads, S-trap connector. The Wc suite to include a 7.5 Litres, high pressure high level cistern including all accessories and connections for its proper functioning. All to be as "Twyford's Oriental" or approved equivalent.</p> <p>Wash hand basin (WHB)-Contertop</p> <p>B White countertop ceramic wash hand basin with single taphole. Preferred dimension: 590 x 455mm x 185mm. with press delay (metering) pillar tap as Docol or approved equivalent and other necessary fittings Basin to be as Twyford or approved equivalent</p> <p>Urinals bowls</p> <p>C Ceramic urinal bowl complete with 40mm heavy duty plastic bottle trap and 40mm diameter chrome plated outlet with grating, top inlet and firmly fixed on the wall with chrome plated screws. The fittings shall be as Lecico or approved equivalent.</p>	11	No		
		10	No		
		1	No.		
	Sub-Total c/f to next page				

Item	Description	Qty	Unit	Rate (Kshs)	Cost (Kshs)
Total b/f from previous page					
A	Urinal Bowl Flush Valves 25mm urinal bowl flush valve for the above urinal bowls complete with, back entry with integral vacuum breaker, non-hold-open features and non-return valve, inlet control stop and wall plate comprising flush valve, bent chrome plated flush pipe and rubber pipe connector. The flush valve to be push button type. The fittings shall be as <i>Docol</i> or approved equivalent.	1	No		
B	Mirror 6mm thick polished plate glass silver backed mirror with bevelled edges, size 610 x 610mm, Plugged and screwed to wall with 4No. chrome plated dome capped screws. The mirror shall rest against a layer of 5mm thick foam.	10	No.		
Sub-Total c/f to next page					
Total b/f from previous page					

Item	Description	Qty	Unit	Rate (Kshs)	Cost (Kshs)
A	<p><u>Disabled Persons Water Closet and Wash Hand Basin facility Comprising of the following:</u></p> <p>A completely assembled unit of wheel chair-accessible toilet combination facility comprising:-</p> <p>1) A close-coupled white in colour WC bowl with horizontal outlet, complete with a 7.5litres cistern with fittings and additional cover clip for additional security, 100mm high 'Avalon' seat ring with chrome-plated metal hinges.</p> <p>2) Wall- mounted wash hand basin with one left-hand or right-hand offset taphole and chainstay hole, wall brackets, lever action chrome-plated 15mm dia. tap, chrome plated chain waste 32mm.</p> <p>3) 4No. 600mm long grabrails.</p> <p>4) 1No. hinged support rail with toilet Roll Holder, and a back support rail, all in nylon-coated aluminium.</p> <p>5) Mirror 400mm wide by 900mm high fixed 900mm above floor level. The whole facility to conform in all aspects to the requirements of LANTAC certificate, Ref. NR35-T-10. To be as TWYFORDS AVALON - DOC.M pac or equal and approved equivalent.</p> <p>iii) Hinged support rail with toilet roll holder 770mm long manufactured in nylon coated aluminium and mounted on a wall fixing plate plate size 230x100 mm, 4No 600mm grab rails with covered wall plates. The set shall be as Twyfords DOC.M wheelchair accessible W.C. facility or approved equivalent.</p>	Set	4		
B	<p>Robe Hook</p> <p>Chrome plated robe hook mounted with concealed screws. To be as Ideal Standard or equal and approved.</p>	12	No.		
B	<p><u>Water Closet (WC)</u></p> <p>Floor standing WC suite in approved colour complete with horizontal outlet to BS 3402 and heavy duty soft close plastic (thin) seat and cover with stainless steel hinges and high level cistern. As Twyford or approved equivalent.</p>	1	No.		
	Sub-Total c/f to next page				
	Total b/f from previous page				

Item	Description	Qty	Unit	Rate (Kshs)	Cost (Kshs)
A	<p>Toilet Roll Holder Semi recessed toilet roll holder in Vitreous China of size 165 x 165mm in approved colour as Twyford or equal and approved</p> <p>INTERNAL PLUMBING PPR Pipes</p> <p>Supply, deliver and install Polypropylene Random (PP-R) 20 pipework to DIN 8077 with joints, couplings, reducers, tees, adaptors, pipe fixing clips etc all to DIN 16962 and DIN 16928 .Pipe jointing shall be by polyfusion or use of electric coupling. Where pipework is not chased proper anchoring using approved fixtures shall be done. No pipework shall be left exposed to the sun. Rates must allow for all Metal/plastic threaded adaptors where required for the connection of sanitary fixtures, valves, sockets, sliding and fixed joints, support raceways, isolating sheaths, elastic materials, expansion arms and bends, crossovers, couplings, clippings, connectors, joints etc. as required in the running lengths of pipework and also where necessary, for pipe fixing clips, holder bats plugged and screwed for the proper and satisfactory functioning of the system.</p>	12	No.		
	PPR PN 20 PIPEWORK				
B	20mm diameter pipework	24	Lm		
C	25mm diameter pipework	18	Lm		
D	32mm diameter pipework	42	Lm		
E	40mm diameter pipework	12	Lm		
F	50mm diameter pipework	0	Lm		
	Bends				
G	20mm diameter bend	22	No.		
H	25mm diameter bend	28	No.		
	Sub-Total c/f to next page				
	Total b/f from previous page				

Item	Description	Qty	Unit	Rate (Kshs)	Cost (Kshs)
A	32mm diameter bend	20	No.		
B	40mm diameter bend	12	No.		
C	50mm diameter bend	0	No.		
	Tees				
D	25mm equal tee	18	No.		
E	32mm equal tee	18	No.		
F	40mm equal tee	10	No.		
G	50mm equal tee	0	No.		
	Reducers				
H	25 x 20mm diameter reducer	16	No.		
J	32 x 20mm diameter reducer	18	No.		
K	32 x 25mm diameter reducer	15	No.		
L	40 x 32mm diameter reducer	10	No.		
M	50 x 32mm diameter reducer	0	No.		
	Valves				
N	25mm gate valve	6	No.		
P	32mm gate valve	4	No.		
Q	40mm gate valve	1	No.		
R	50mm gate valve	0	No.		
	Unions				
S	25mm diameter pipe unions	12	No.		
T	32mm diameter pipe unions	8	No.		
	Sub-Total c/f to next page				
	Total b/f from previous page				

Item	Description	Qty	Unit	Rate (Kshs)	Cost (Kshs)
A	40mm diameter pipe unions	2	No.		
B	50mm diameter pipe unions	0	No.		
	Male/Female Adapters (Brass threaded)				
C	20mmx1/2 brass threaded adapter	22	No.		
	Adaptor Union / Brass Female Threaded				
D	25mmX3/4" threaded brass coupling	16	No.		
	Flexible Tubing				
E	15mm diameter x 300mm long flexible connectors complete with integral chrome plated angle valve as Cobra or equal and approved.	22	No.		
	Pipe Sleeves				
F	65mm diameter heavy duty PVC pipe sleeves for crossing over columns and beams.	12	Lm		
	Ground Water Tank				
	Supply, deliver and install cylindrical plastic moulded tank of capacity 10,000 litres. The tank to be assembled complete with cover and having screwed connections for inlet, outlet, overflow, drain pipes and any other necessary item for its proper functioning. The tank shall be mounted on a flat slab and shall be as Roto or approved equivalent	2	No.		
	Roof Water tanks				
	Supply, deliver and install cylindrical plastic moulded tank of capacity 5,000 litres. The tank to be assembled complete with cover and having screwed connections for inlet, outlet, overflow, drain pipes and any other necessary item for its proper functioning. The tank shall be mounted on a flat slab and shall be as Roto or approved equivalent	2	No.		
	Sub-Total c/f to next page				
	Total b/f from previous page				

Item	Description	Qty	Unit	Rate (Kshs)	Cost (Kshs)
A	Booster Pump Set Pedrollo water booster pump set: Pedrollo Nkm 2/3, Duty 4.0m ³ /hr or equal and approved, complete with pressure gauge, pressure switch (or complete hydrostat), non return valves, isolating valves, 1phase 230V 50Hz motor power 0.75KW.	1	NO.		
B	Booster Pump Set Pedrollo water booster pump set: Pedrollo Nkm 2/3, Duty 4.0m ³ /hr or equal and approved, complete with pressure gauge, pressure switch (or complete hydrostat), non return valves, isolating valves, 1phase 230V 50Hz motor power 0.75KW.	1	NO.		
C	Excavate trench for 50mm pipe not exceeding 1500mm deep and average 250mm deep, part return in, fill & surplus cut away.	30	Lm		
D	Testing and commissioning Allow for testing and commissioning of the Internal plumbing installations	1	Item		
FOUL WATER INTERNAL DRAINAGE					
Supply ,deliver and install the following UPVC, MUPVC, soil and waste systems respectively to B.S 5255 with fittings fixed to Manufactures Printed instructions and manufactured by reputable manufacturers. Tenderers must allow in their pipework prices for all the couplings, clippings, connectors, joints etc. as required in the running lengths of pipework and also where necessary, for pipe fixing clips, holder bats plugged and screwed for the proper and satisfactory functioning of the system.					
MuPVC and uPVC Waste and Soil pipework					
E	150mm diameter heavy gauge golden brown UPVC pipe	130	Lm		
F	100mm diameter heavy gauge golden brown UPVC pipe	42	Lm		
Sub-Total c/f to next page					

Item	Description	Qty	Unit	Rate (Kshs)	Cost (Kshs)
Total b/f from previous page					
A	100mm diameter heavy gauge grey mUPVC pipe	28	Lm		
B	50mm diameter waste pipe	42	Lm		
C	40mm diameter waste pipe	24	Lm		
D	32mm diameter waste pipe	18	Lm		
Bends					
E	100mm diameter long radius bend	12	No.		
F	100mm diameter short radius bend	12	No.		
G	100mm diameter bend with access	12	No.		
H	100mm diameter sweep bend	14	No.		
J	50mm diameter sweep bend	8	No.		
K	40mm diameter sweep bend	12	No.		
L	32mm diameter sweep bend	16	No.		
Tees					
M	100mm diameter sweep tee	14	No.		
N	50mm diameter sweep tee	6	No.		
P	40mm diameter sweep tee	8	No.		
Q	32mm diameter sweep tee	12	No.		
Access Caps					
R	100mm diameter access cap	10	No.		
S	40mm diameter access cap	10	No.		
T	32mm diameter access cap	12	No.		
Boss Connectors					
U	100 x 50mm diameter boss connector	14	No.		
Sub-Total c/f to next page					

Item	Description	Qty	Unit	Rate (Kshs)	Cost (Kshs)
Total b/f from previous page					
A	100x 40mm diameter boss connector	14	No.		
Single Branches					
B	100mm diameter single branch	10	No.		
WC Connectors					
C	100mm diameter WC connector	13	No.		
Traps					
D	100 x 50mm diameter floor trap and grating	10	No.		
E	Allow for a standard 300 x 300 x 450mm masonry gully trap complete with concrete cover.	6	No.		
Manholes and Inspection Chambers					
F	Construct inspection chamber size 600 x 450mm and averaging 750mm deep constructed in 100mm thick concrete base (1:3:6), approved 150mm block sides rendered all around in cement and sand (1:4). It shall have an approved heavy duty cast iron cover and frame as manufactured by E.A Foundry works. Include all necessary excavations, disposal and form work. To be as manhole type 'A'.	10	No.		
Weathering Slates and Vent Cows					
G	100mm diameter weathering slate and apron.	14	No.		
H	100mm diameter vent cowl	14	No.		
J	Excavate trench for 150mm pipe not exceeding 1500mm deep and average 250mm deep, part return in, fill & surplus cut away.	80	Lm		
K	Allow for connection to the existing drainage	1	item		
Testing and commissioning					
L	Allow for testing and commissioning of the Internal drainage installations	1	Item		
Sub-Total c/f to next page					

Item	Description	Qty	Unit	Rate (Kshs)	Cost (Kshs)
Total b/f from previous page					
	Portable Fire Extinguishers Supply, deliver, install, test and commission the following portable fire extinguishers and conforming to BS EN 3 / BS 1449.				
A	Water Fire Extinguisher 9 litres water portable fire extinguisher complete with pressure gauge, initial charge and mounting brackets.	2	No		
B	Carbon Dioxide Gas Fire Extinguisher 9 litres carbon dioxide gas portable fire extinguisher complete with pressure gauge, initial charge and mounting brackets.	2	No		
C	DCP Fire Extinguisher Dry Chemical Powder fire extinguisher complete with initial charge and mounting brackets.	2	No		
D	Manual Bell Manual Bell	2	No		
E	Fire cabinets to accommodate a set of fire portables and horsereel	2	No		
F	Fire Notices Allow for fire signage for the hose reel system, fire exits, fire instructions as directed by engineer	2	No		
G	Testing and commissioning Allow for testing and commissioning of the Fire fighting equipment installations	1	Item		
Total for ground floor C/F to Mechanical works summary page					

Item	Description	Qty	Unit	Rate (Kshs)	Cost (Kshs)
------	-------------	-----	------	-------------	-------------

FIRST FLOOR

	<p>SANITARY APPLIANCES Supply, deliver, install, test and commission the following sanitary appliances complete with all the accessories including all connections to the services, waste, jointing to water supply overflows, supports and all plugging and screwing to walls and floors. (i) All sanitary fittings shall be in approved colour. (ii) The Model and Ref No. indicated is only a guide to the type and quality of fittings. (iii) Equivalent and Approved models may be acceptable.</p> <p>Squatting Water Closet (WC) A Squatting water closet suite in vitreous china comprising of water closet bowl with top plate and integral foot threads, S-trap connector. The Wc suite to include a 7.5 Litres, high level cistern including all accesories and conections for its proper functioning.All to be as "Twyfords Oriental" or approved equivalent.</p> <p>Wash hand basin (WHB)- Countertop B White countertop ceramic wash hand basin with single taphole. Prefered dimension: 590 x 455mm x 185mm.with press delay(metering) pillar tap as Docol or approved equivalent and other necessary fittings Basin to be as Twyford or approved equivalent</p>	<p>11</p> <p>10</p>	<p>No</p> <p>No</p>		
Sub-Total c/f to next page					

Item	Description	Qty	Unit	Rate (Kshs)	Cost (Kshs)
Total b/f from previous page					
	<p>Disabled Persons Water Closet and Wash Hand Basin Facility, Wheel chair accessible W.C facility Comprising of the following:</p> <p>A completely assembled unit of wheel chair-accessible toilet combination facility comprising:-</p> <p>1) A close-coupled white in colour WC bowl with horizontal outlet, complete with a 7.5litres cistern with fittings and additional cover clip for additional security, 100mm high 'Avalon' seat ring with chrome-plated metal hinges.</p> <p>2) Wall- mounted wash hand basin with one left-hand or right-hand offset taphole and chainstay hole, wall brackets, lever action chrome-plated 15mm dia. tap, chrome plated chain waste 32mm.</p> <p>3) 4No. 600mm long grabrails.</p> <p>4) 1No. hinged support rail with toilet Roll Holder, and a back support rail, all in nylon-coated aluminium.</p> <p>5) Mirror 400mm wide by 900mm high fixed 900mm above floor level. The whole facility to conform in all aspects to the requirements of LANTAC certificate, Ref. NR35-T-10. To be as TWYFORDS AVALON - DOC.M pac or equal and approved equivalent.</p> <p>iii) Hinged support rail with toilet roll holder 770mm long manufactured in nylon coated aluminium and mounted on a wall fixing plate plate size 230x100 mm, 4No 600mm grab rails with covered wall plates. The set shall be as Twyfords DOC.M wheelchair accessible W.C. facility or approved equivalent.</p>				
A		Set	4		
B	<p>Robe Hook Chrome plated robe hook mounted with concealed screws. To be as Ideal Standard or equal and approved.</p>	12	No.		
C	<p>Urinals bowls Ceramic urinal bowl complete with 40mm heavy duty plastic bottle trap and 40mm diameter chrome plated outlet with grating, top inlet and firmly fixed on the wall with chrome plated screws. The fittings shall be as Lecico or approved equivalent.</p>	1	No.		
Sub-Total c/f to next page					

Item	Description	Qty	Unit	Rate (Kshs)	Cost (Kshs)
Total b/f from previous page					
A	Urinal Bowl Flush Valves				
	25mm urinal bowl flush valve for the above urinal bowls complete with, back entry with integral vacuum breaker, non-hold-open features and non-return valve, inlet control stop and wall plate comprising flush valve, bent chrome plated flush pipe and rubber pipe connector. The flush valve to be push button type. The fittings shall be as <i>Docol</i> or approved equivalent.	1	No		
B	Toilet Roll Holder				
	Semi recessed toilet roll holder in Vitreous China of size 165 x 165mm in approved colour as Twyford or equal and approved	12	No.		
C	Mirror				
	6mm thick polished plate glass silver backed mirror with bevelled edges, size 610 x 610mm, Plugged and screwed to wall with 4No. chrome plated dome capped screws. The mirror shall rest against a layer of 5mm thick foam.	10	No.		
Sub-Total c/f to next page					

Item	Description	Qty	Unit	Rate (Kshs)	Cost (Kshs)
Total b/f from previous page					
INTERNAL PLUMBING					
PPR Pipes					
Supply, deliver and install Polypropylene Random (PP-R) 20 pipework to DIN 8077 with joints, couplings, reducers, tees, adaptors, pipe fixing clips etc all to DIN 16962 and DIN 16928 .Pipe jointing shall be by polyfusion or use of electric coupling. Where pipework is not chased proper anchoring using approved fixtures shall be done. No pipework shall be left exposed to the sun. Rates must allow for all Metal/plastic threaded adaptors where required for the connection of sanitary fixtures, valves, sockets, sliding and fixed joints, support raceways, isolating sheaths, elastic materials, expansion arms and bends, crossovers, couplings, clippings, connectors, joints etc. as required in the running lengths of pipework and also where necessary, for pipe fixing clips, holder bats plugged and screwed for the proper and satisfactory functioning of the system.					
PPR PN 20 PIPEWORK					
A	20mm diameter pipework	24	Lm		
B	25mm diameter pipework	18	Lm		
C	32mm diameter pipework	30	Lm		
D	40mm diameter pipework	16	Lm		
E	50mm diameter pipework	10	Lm		
F	63mm diameter pipework	10	Lm		
Bends					
G	20mm diameter bend	42	No.		
H	25mm diameter bend	36	No.		
J	32mm diameter bend	24	No.		
Sub-Total c/f to next page					

Item	Description	Qty	Unit	Rate (Kshs)	Cost (Kshs)
Total b/f from previous page					
A	40mm diameter bend	12	No.		
B	50mm diameter bend	6	No.		
C	63mm diameter bend	6	No.		
Tees					
D	25mm equal tee	30	No.		
E	32mm equal tee	18	No.		
F	40mm equal tee	14	No.		
G	50mm equal tee	2	No.		
H	63mm equal tee	2	No.		
Reducers					
J	25 x 20mm diameter reducer	32	No.		
K	32 x 20mm diameter reducer	18	No.		
L	32 x 25mm diameter reducer	15	No.		
M	40 x 32mm diameter reducer	10	No.		
N	50 x 32mm diameter reducer	2	No.		
P	50 x 40mm diameter reducer	2	No.		
Q	63 x 50mm diameter reducer	2	No.		
Valves					
R	25mm gate valve	6	No.		
S	32mm gate valve	4	No.		
T	40mm gate valve	3	No.		
U	50mm gate valve	2	No.		
Sub-Total c/f to next page					

Item	Description	Qty	Unit	Rate (Kshs)	Cost (Kshs)
Total b/f from previous page					
A	63mm gate valve	2	No.		
Unions					
B	25mm diameter pipe unions	12	No.		
C	32mm diameter pipe unions	8	No.		
D	40mm diameter pipe unions	6	No.		
E	50mm diameter pipe unions	4	No.		
F	63mm diameter pipe unions	4	No.		
Male/Female Adapters (Brass threaded)					
G	20mmx1/2 brass threaded adapter	30	No.		
Adaptor Union / Brass Female Threaded					
H	25mmX3/4" threaded brass coupling	21	No.		
Flexible Tubing					
J	15mm diameter x 300mm long flexible connectors complete with integral chrome plated angle valve as Cobra or equal and approved.	24	No.		
Pipe Sleeves					
K	65mm diameter heavy duty PVC pipe sleeves for crossing over columns and beams.	10	Lm		
L	Testing and commissioning Allow for testing and commissioning of the Internal plumbing installations	1	Item		
Sub-Total c/f to next page					

Item	Description	Qty	Unit	Rate (Kshs)	Cost (Kshs)
Total b/f from previous page					
FOUL WATER INTERNAL DRAINAGE					
Supply ,deliver and install the following UPVC, MUPVC, soil and waste systems respectively to B.S 5255 with fittings fixed to Manufactures Printed instructions and manufactured by reputable manufacturers. Tenderers must allow in their pipework prices for all the couplings, clippings, connectors, joints etc. as required in the running lengths of pipework and also where necessary, for pipe fixing clips, holder bats plugged and screwed for the proper and satisfactory functioning of the system.					
MuPVC and uPVC Waste and Soil pipework					
A	100mm diameter heavy gauge golden brown UPVC pipe	30	Lm		
B	100mm diameter heavy gauge grey mUPVC pipe	24	Lm		
C	50mm diameter waste pipe	30	Lm		
D	40mm diameter waste pipe	24	Lm		
E	32mm diameter waste pipe	18	Lm		
Bends					
F	100mm diameter long radius bend	6	No.		
G	100mm diameter short radius bend	6	No.		
H	100mm diameter bend with access	6	No.		
J	100mm diameter sweep bend	4	No.		
K	50mm diameter sweep bend	8	No.		
L	40mm diameter sweep bend	10	No.		
M	32mm diameter sweep bend	16	No.		
Tees					
N	100mm diameter sweep tee	8	No.		
Sub-Total c/f to next page					

Item	Description	Qty	Unit	Rate (Kshs)	Cost (Kshs)
Total b/f from previous page					
A	50mm diameter sweep tee	6	No.		
B	40mm diameter sweep tee	8	No.		
C	32mm diameter sweep tee	12	No.		
Access Caps					
D	100mm diameter access cap	12	No.		
E	40mm diameter access cap	12	No.		
F	32mm diameter access cap	12	No.		
Boss Connectors					
G	100 x 50mm diameter boss connector	14	No.		
H	100x 40mm diameter boss connector	14	No.		
Single Branches					
J	100mm diameter single branch	14	No.		
WC Connectors					
K	100mm diameter WC connector	15	No.		
Traps					
L	100 x 50mm diameter floor trap and grating	10	No.		
Weathering Slates and Vent Cows					
M	100mm diameter weathering slate and apron.	6	No.		
N	100mm diameter vent cowl	8	No.		
P	Testing and commissioning Allow for testing and commissioning of the Internal drainage installations	1	Item		
Sub-Total c/f to next page					

Item	Description	Qty	Unit	Rate (Kshs)	Cost (Kshs)
	Total b/f from previous page				
	Portable Fire Extinguishers <u>Supply, deliver, install, test and commission the following portable fire extinguishers and conforming to BS EN 3 / BS 1449.</u>				
A	Water Fire Extinguisher 9 litres water portable fire extinguisher complete with pressure gauge, initial charge and mounting brackets.	2	No		
B	Carbon Dioxide Gas Fire Extinguisher 9 litres carbon dioxide gas portable fire extinguisher complete with pressure gauge, initial charge and mounting brackets.	2	No		
C	DCP Fire Extinguisher Dry Chemical Powder fire extinguisher complete with initial charge and mounting brackets.	2	No		
D	Manual Bell Manual Bell	2	No		
E	Fire cabinets to accommodate a set of fire portables	2	No		
F	Fire Notices Allow for fire signage for the hose reel system, fire exits, fire instructions as directed by engineer	2	No		
G	Testing and commissioning Allow for testing and commissioning of the Fire fighting equipment installations	1	Item		
	Total for 1 No. typical floor				
	Total amount for First Floor c/f to mechanical works summary page				

Item	Description	Qty	Unit	Rate (Kshs)	Cost (Kshs)
------	-------------	-----	------	----------------	-------------

SUMMARY PAGE FOR MECHANICAL WORKS

1	Total for special preliminaries B/F from page Mech				
1	Total for ground floor B/F from page Mech				
2	Total amount for First Floor B/F from page Mech				
Total Amount for Mechanical works C/F to main document summary					

PROVISIONAL SUMS

ITEM	DESCRIPTION	QTY	UNIT	RATE	AMOUNT
	<u>PROVISIONAL SUMS</u>				
	<u>The following provisional sums are to be measured on completion and priced in accordance with the rates contained in these bills of quantities or prorata thereto or deducted in whole if not required</u>				
A	Allow a provisional sum of Kenya Shillings Two Million (Kshs 2,000,000.00) only for Contingencies		ITEM		2,000,000.00
B	Allow a provisional sum of Kenya Shillings Five Hundred Thousand (Kshs 500,000.00) only for Civil Works		ITEM		500,000.00
TOTAL FOR PROVISIONAL SUMS CARRIED TO GRAND SUMMARY					2,500,000.00

GRAND SUMMARY

**PROPOSED CONSTRUCTION OF ADMINISTRATION AND TUITION COMPLEX -
PHASE 1 AT KARUMO TECHNICAL TRAINING INSTITUTE**

GRAND SUMMARY

ITEM	DESCRIPTION	Page No.	FOR TENDERER USE ONLY	FOR OFFICIAL USE ONLY
			K.SHS.	K.SHS.
A	PARTICULAR PRELIMINARIES	PP/7		
B	GENERAL PRELIMINARIES	GP/19		
C	BUILDER'S WORKS	BWS/1		
D	ELECTRICAL WORKS	ELC/16		
E	MECHANICAL WORKS	MECH/21		
F	PROVISIONAL SUMS	PS/1		
	SUB-TOTAL			
	GRAND TOTAL (IN KSHS) CARRIED TO FORM OF TENDER			

Amount in words. Kenya shillings

.....Cents

Tenderer's Signature and stamp

Address

Date

Witness Signature

Address

Date

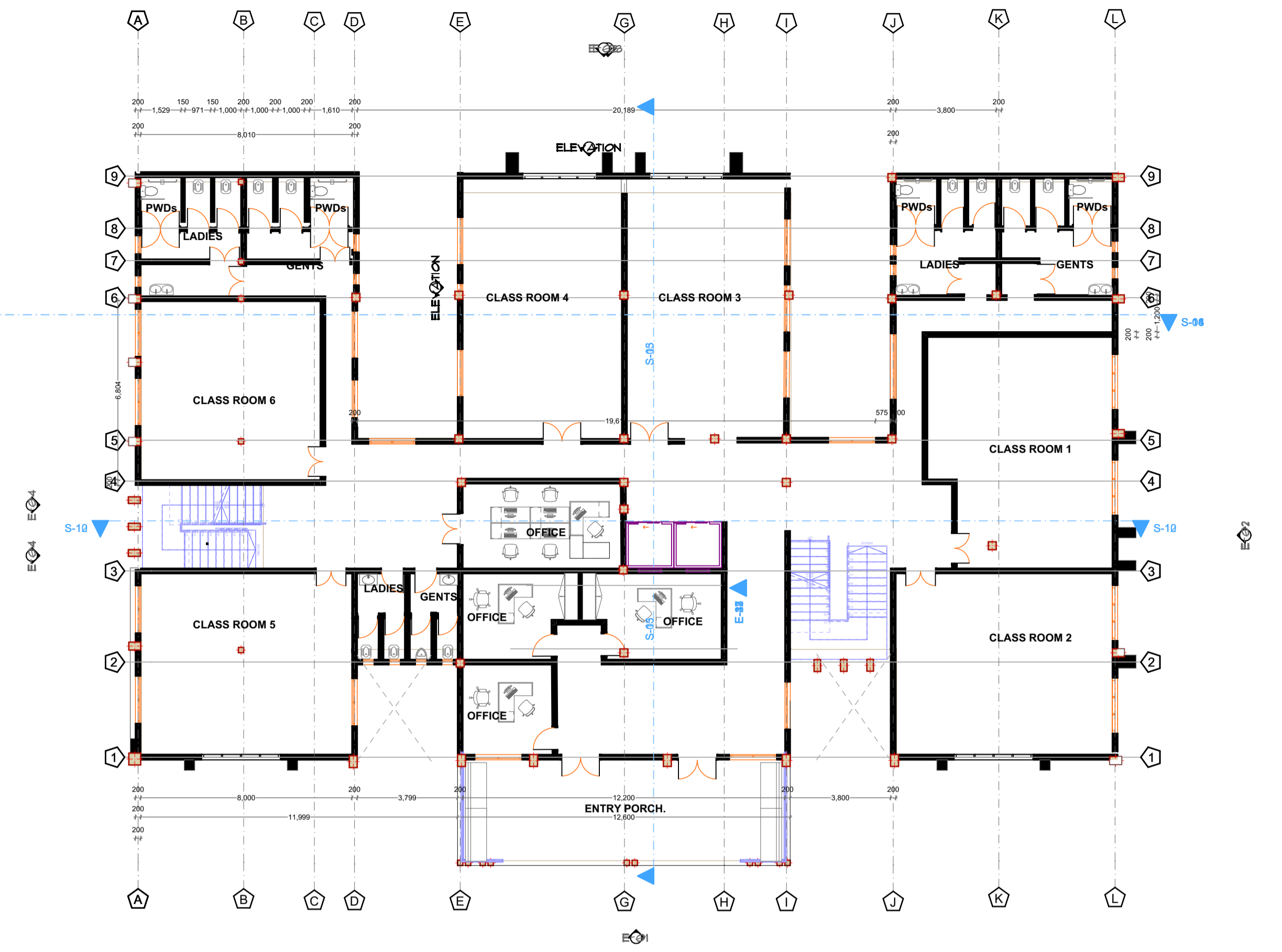
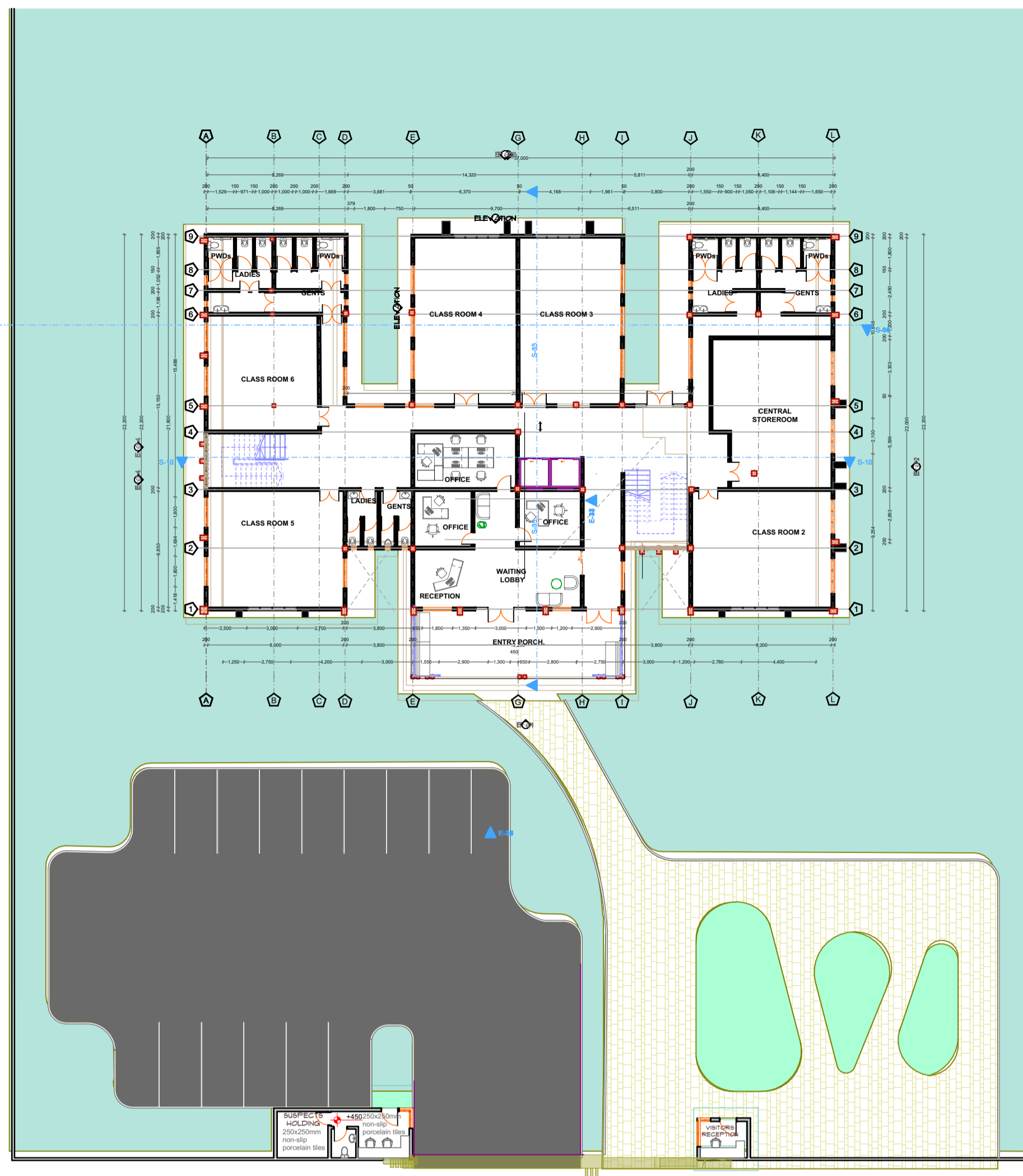

Story 1 /Story 2/story3/Story 4Typical

1.

Story

1:150

0. Ground Floor 1:250

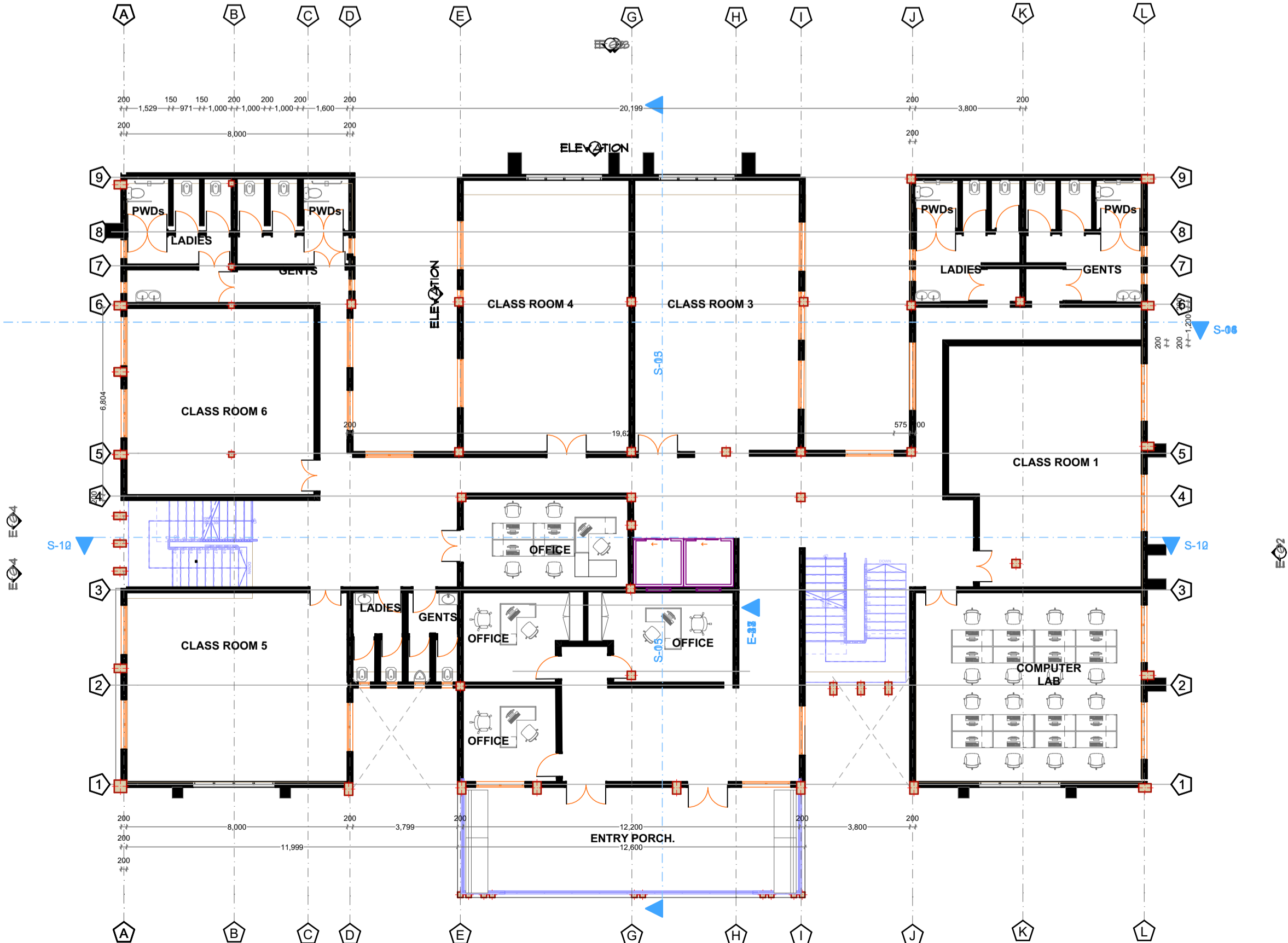

Story 5/story6 Typical

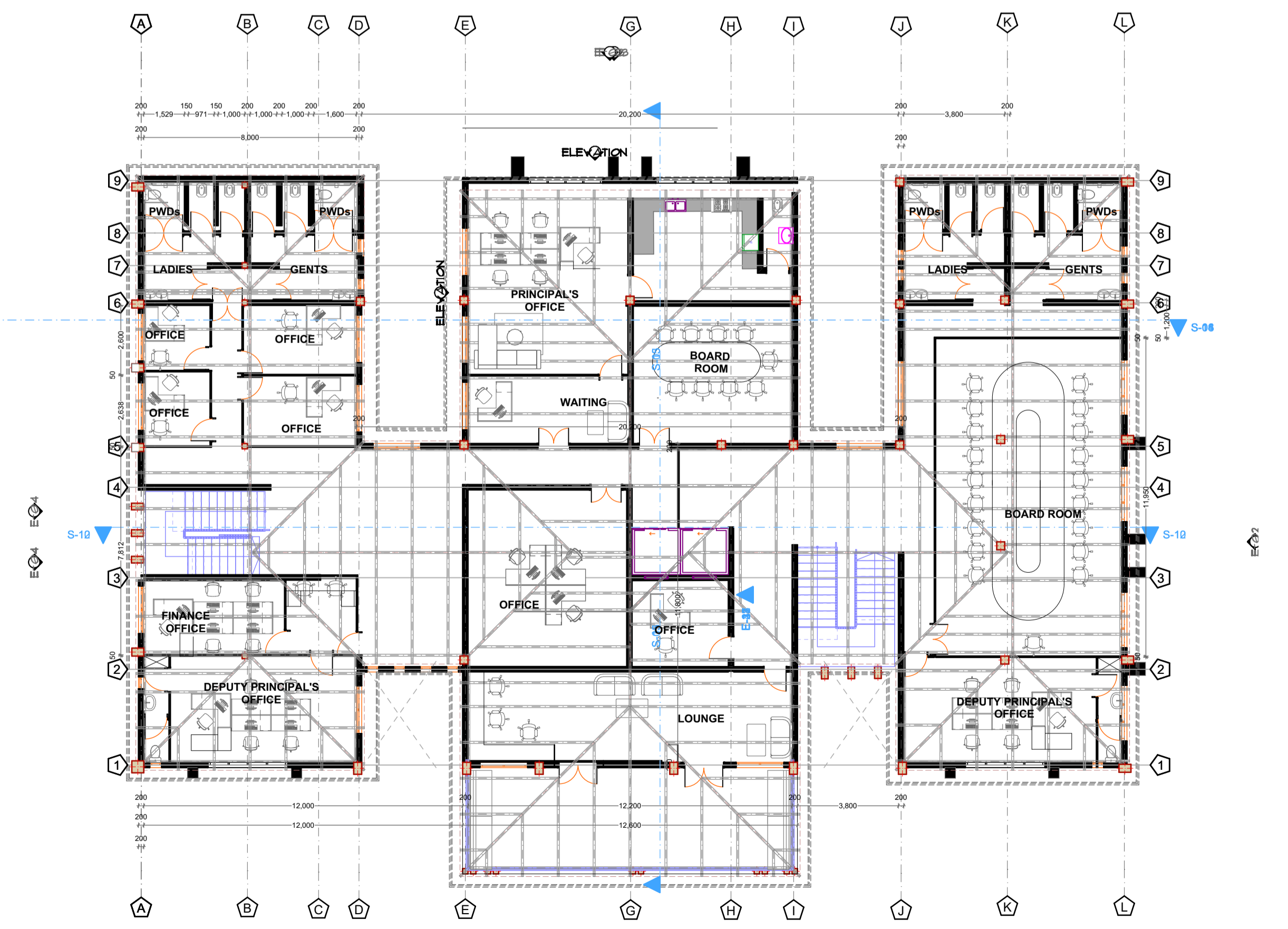

Story 7

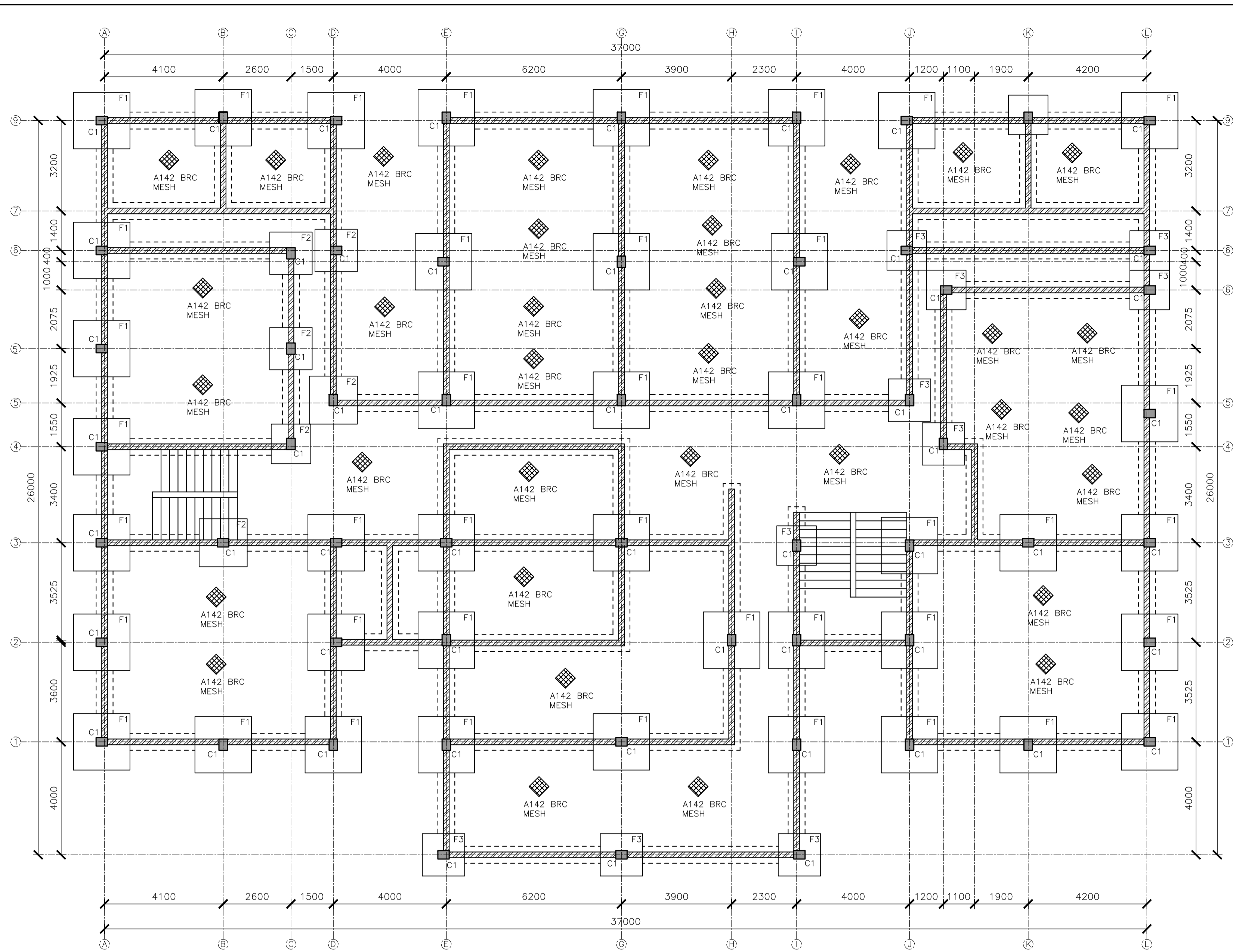

FOUNDATION LAYOUT

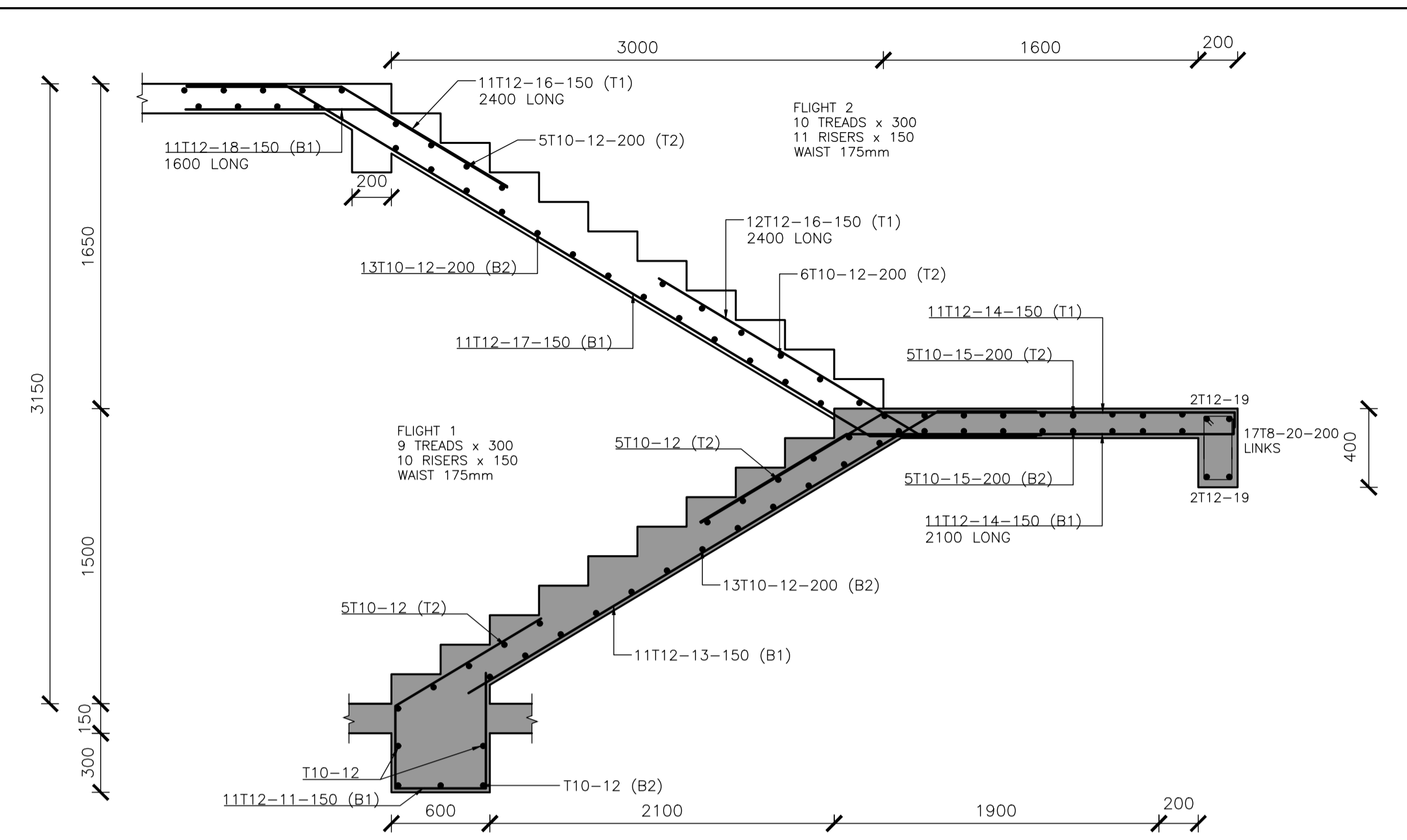

SECTION THRO' GROUND FLOOR STAIRCASE

- NOTES**
- ALL DIMENSIONS AND LEVELS TO BE VERIFIED AND CONFIRMED ON SITE
 - CONCRETE SHALL BE 1:1.5:3 MIX, CLASS 25 / 25
 - COVER SHALL BE AS FOLLOWS (UNLESS OTHERWISE SHOWN)
SLAB - 20mm, BEAMS - 25mm, STAIRS - 20mm, HOLLOW POT SLAB - 20mm
COLUMNS AND GROUND BEAMS - 40mm, FOOTINGS - 50mm
WALLS (TO VERTICAL BARS) - 25mm.
 - FOUNDATIONS ARE DESIGNED FOR A SAFE BEARING PRESSURE OF 200 kN/m² AND SHALL BE SUBJECT TO VERIFICATION ON SITE
 - 50mm BLINDING SHALL BE PROVIDED UNDER ALL R.C FOOTINGS AND GROUND BEAMS
 - SYMBOLS:
T1- TOP BARS UPPER LAYER
T2- TOP BARS LOWER LAYER
B1- BOTTOM BARS LOWER LAYER
B2- BOTTOM BARS UPPER LAYER
NF- NEAR FACE EF- EACH FACE
FF- FAR FACE BF- BOTH FACES
D.O.S - DETERMINED ON SITE
 - REINFORCEMENT LAPPING TO BE 50D

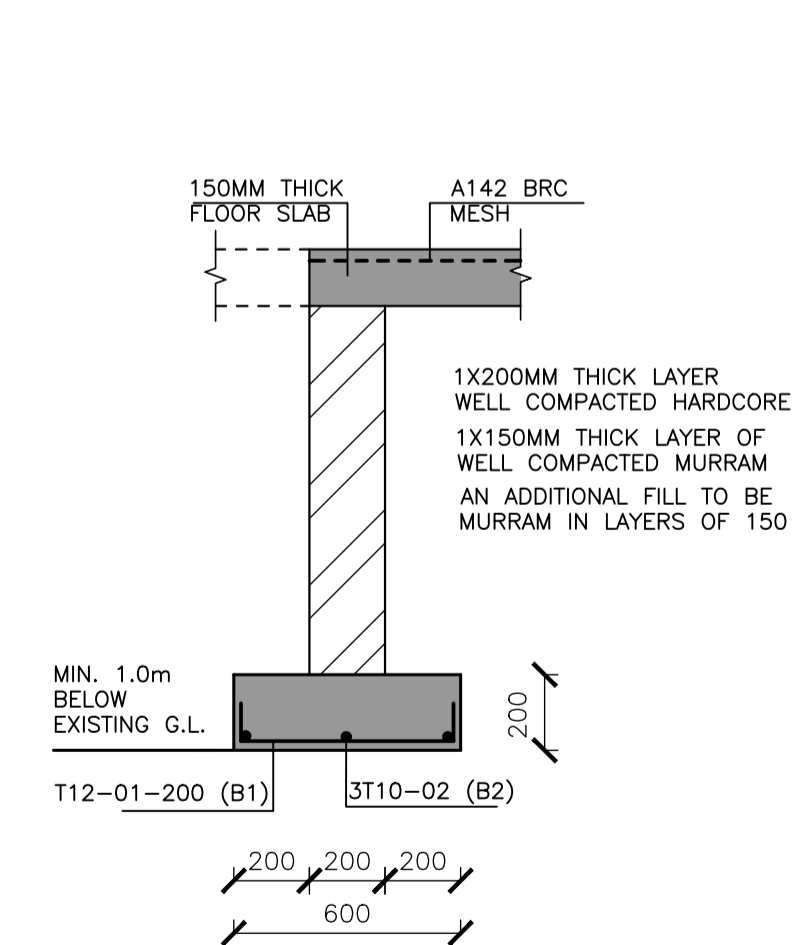

TYPICAL WALL STRIP FOOTING

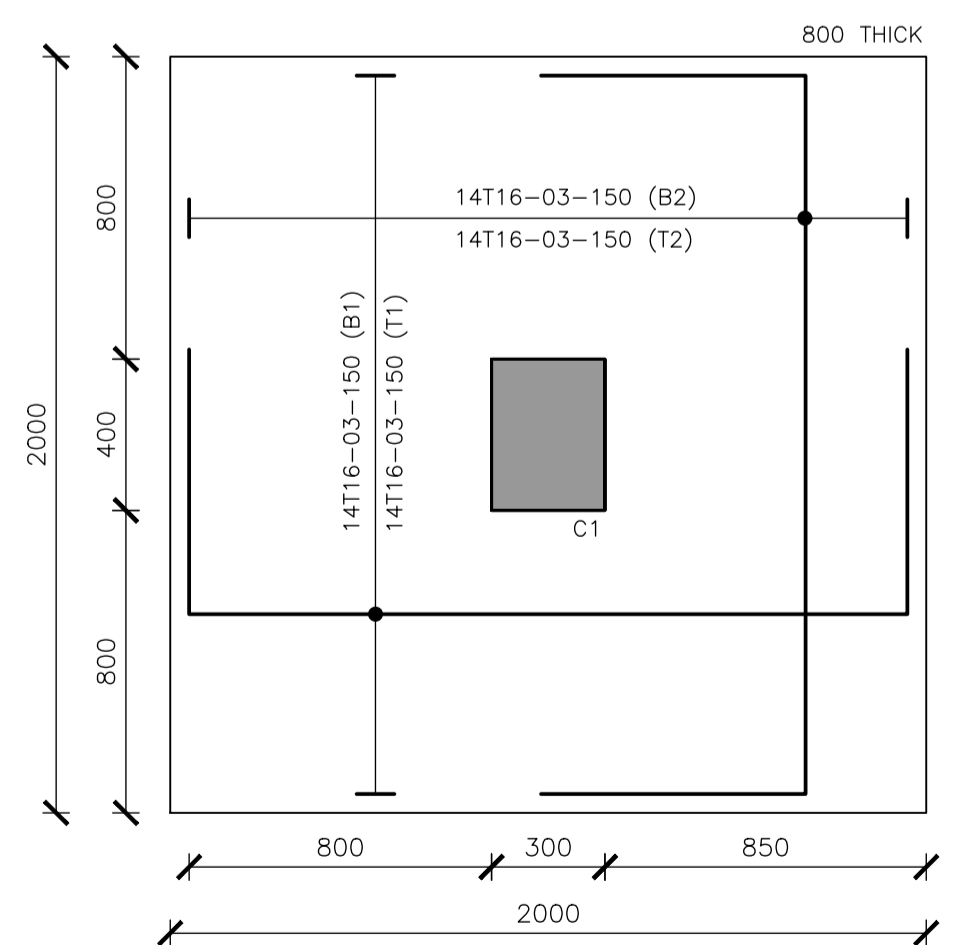

FOOTING F1

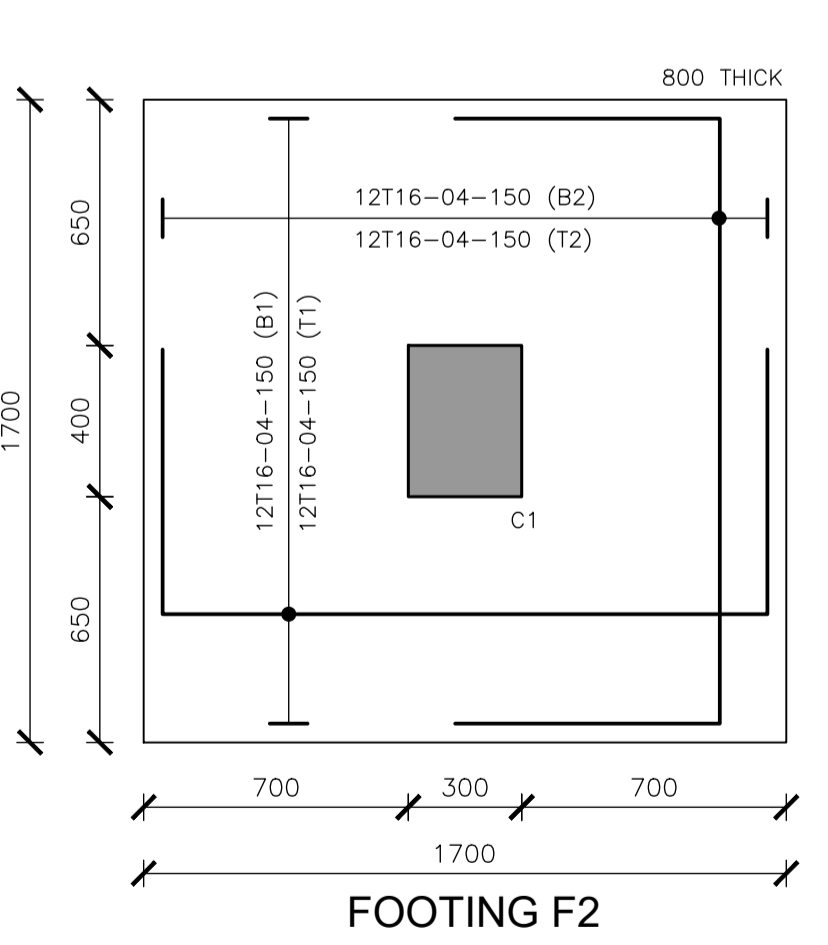

FOOTING F2

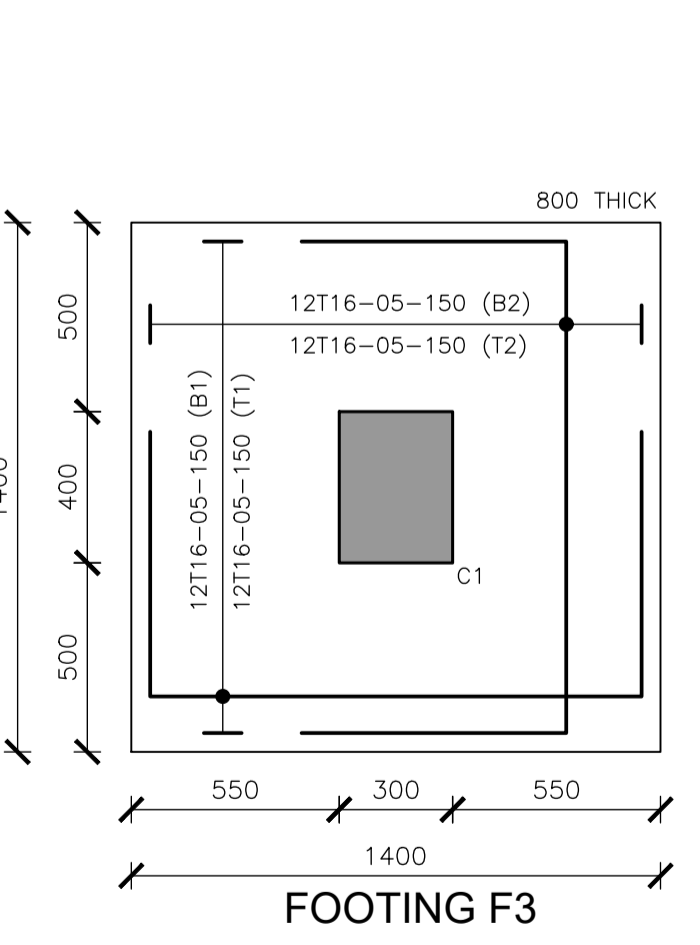

FOOTING F3

REVISIONS			
No	DATE	BY	DESCRIPTION
PROJECT TITLE			
PROPOSED CHAIRMAN COMPLEX BLOCK			
CLIENT			
KARUMO TECHNICAL TRAINING INSTITUTE			
CLIENT'S APPROVAL:..... DATE:.....			
DRG TITLE			
FOUNDATION LAYOUT, FOOTING BASES REINFORCEMENT DETAILS AND SECTION THROUGH GROUND FLOOR STAIRCASE.			
SCALES:		DRG SIZE:	
1:100, 1:25, 1:20		A1	
PROJECT NO		DRAWING NO:	
		01	
	NAME	SIGNATURE	DATE
DRAWN	R. MWANDOE		30TH APRIL, 2024
DESIGNED	R. MWANDOE		30TH APRIL, 2024
CHECKED	ENG. NICHOLAS N.		30TH APRIL, 2024
APPROVED			
ENG. NICHOLAS NGUGI REGIONAL WORKS OFFICER - EASTERN REGION			

STATE DEPARTMENT FOR PUBLIC WORKS
REGIONAL WORKS OFFICE - EASTERN
P.O. BOX 455-60100 EMBU
STRUCTURAL DEPARTMENT

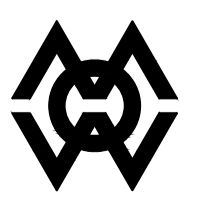

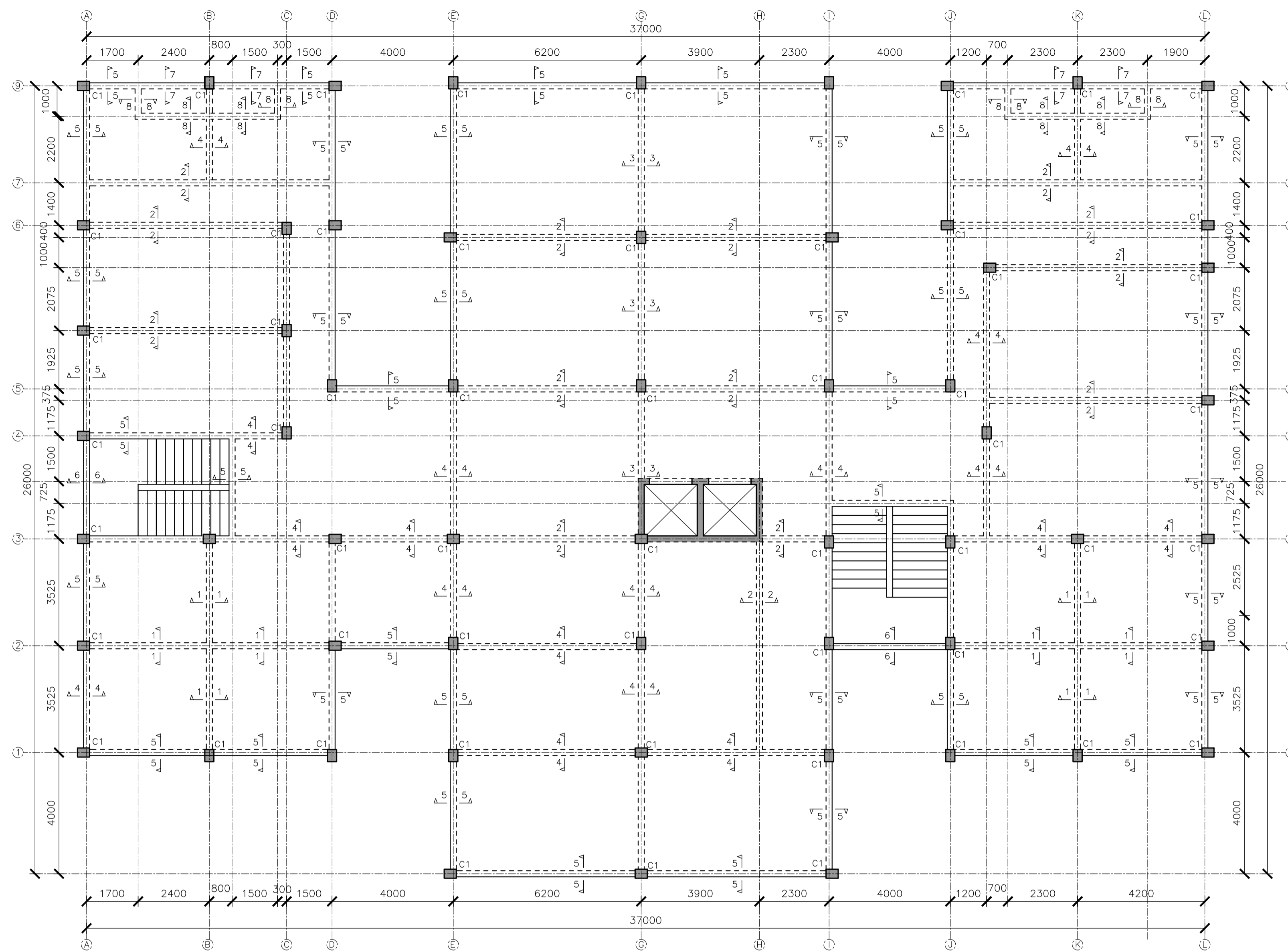

TYPICAL FIRST TO SIXTH FLOOR SLAB LAYOUT

150mm THICK SLAB THROUGHOUT UNLESS OTHERWISE SHOWN

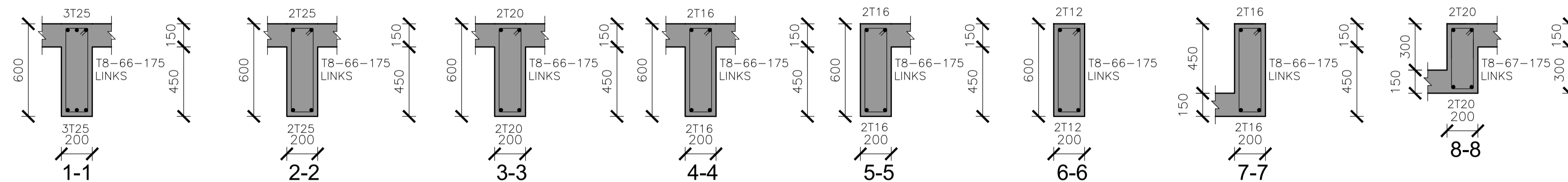

NOTES

- ALL DIMENSIONS AND LEVELS TO BE VERIFIED AND CONFIRMED ON SITE
- CONCRETE SHALL BE 1:1.5:3 MIX, CLASS 25 / 25
- COVER SHALL BE AS FOLLOWS (UNLESS OTHERWISE SHOWN)
SLAB - 20mm, BEAMS - 25mm, STAIRS - 20mm, HOLLOW POT SLAB - 20mm
COLUMNS AND GROUND BEAMS - 40mm, FOOTINGS - 50mm
WALLS (TO VERTICAL BARS) - 25mm.
- FOUNDATIONS ARE DESIGNED FOR A SAFE BEARING PRESSURE OF 200 kN/m² AND SHALL BE SUBJECT TO VERIFICATION ON SITE
- 50mm, BLINDING SHALL BE PROVIDED UNDER ALL R.C FOOTINGS AND GROUND BEAMS
- SYMBOLS:
T1- TOP BARS UPPER LAYER
T2- TOP BARS LOWER LAYER
B1- BOTTOM BARS LOWER LAYER
B2- BOTTOM BARS UPPER LAYER
NF- NEAR FACE EF- EACH FACE
FF- FAR FACE BF- BOTH FACES
D.O.S- DETERMINED ON SITE
- REINFORCEMENT LAPPING TO BE 50D

REVISIONS

No	DATE	BY	DESCRIPTION

PROJECT TITLE

PROPOSED CHAIRMAN COMPLEX BLOCK

CLIENT

KARUMO TECHNICAL TRAINING INSTITUTE

CLIENT'S APPROVAL:..... DATE:.....

DRG TITLE

TYPICAL FIRST TO 6TH FLOOR SLAB LAYOUT AND BEAMS REINFORCEMENT DETAILS

SCALES: 1:100, 1:20	DRG SIZE: A1
------------------------	-----------------

PROJECT NO	DRAWING NO: 03
------------	-------------------

	NAME	SIGNATURE	DATE
DRAWN	R. MWANDOE		30TH APRIL, 2024
DESIGNED	R. MWANDOE		30TH APRIL, 2024
CHECKED	ENG. NICHOLAS N.		30TH APRIL, 2024

APPROVED
ENG. NICHOLAS NGUGI
REGIONAL WORKS OFFICER – EASTERN REGION

STATE DEPARTMENT FOR PUBLIC WORKS

REGIONAL WORKS OFFICE – EASTERN

P.O. BOX 455-60100 EMBU

STRUCTURAL DEPARTMENT

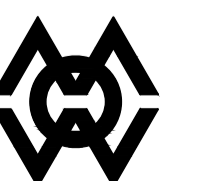

ELECTRICAL DEVICE SCHEDULE		DESCRIPTION
Quantity	KEY	
14	⚡	BULLET TYPE CCTV CAMERA
3	📹	DOMED TYPE CCTV CAMERA
10	⚡	DOUBLE POLE SWITCH
17	⚡	1G1W SWITCH
1	X	INTERMEDIATE SWITCH
13	🔥	SMOKE DETECTOR
17	🔦	SURFACE MOUNTED CIRCULAR 18W DOWNLIGHT
66	🔦	13A TWIN SOCKET
35	🔦	200MM DIA. CIRCULAR RECESSED CEILING LED DOWNLIGHT 11W,
61	🔦	600 X 600 36W LED PANNEL
14	📶	TWIN DATA POINTS
7	📶	WIRELESS ACCESS POINT
3	🔦	MIRROR LIGHT
2	🔦	200MM DIA. SURFACE MOUNTAIN CIRCULAR 20W LAMPS
2	🚪	EXIT LIGHT
2	🚪	BREAK GLASS
1	🔊	FIRE ALARM SOUND
1	🔊	FIRE ALARM PANEL
2	⚡	2G1W SWITCH
15	🔦	1200MM, 1X36W, 4000K 100LM/W SLIM SECTION, 1P 20 LED BATTEN FITTING WITH AS PHILIPS COZY TMS018 C OR APPROVED EQUIVALENT.
2	⚡	2 GANG 2 WAY SWITCH

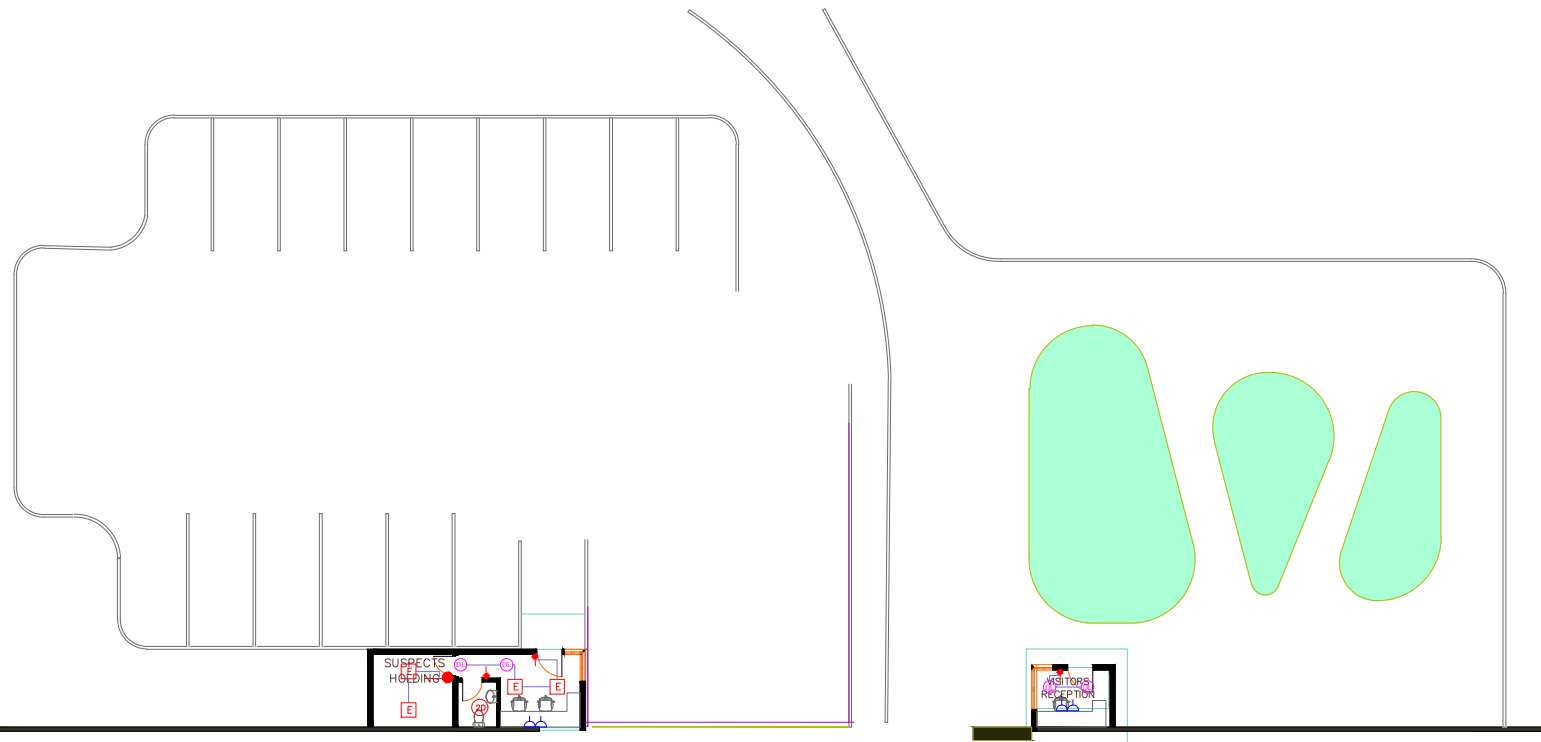
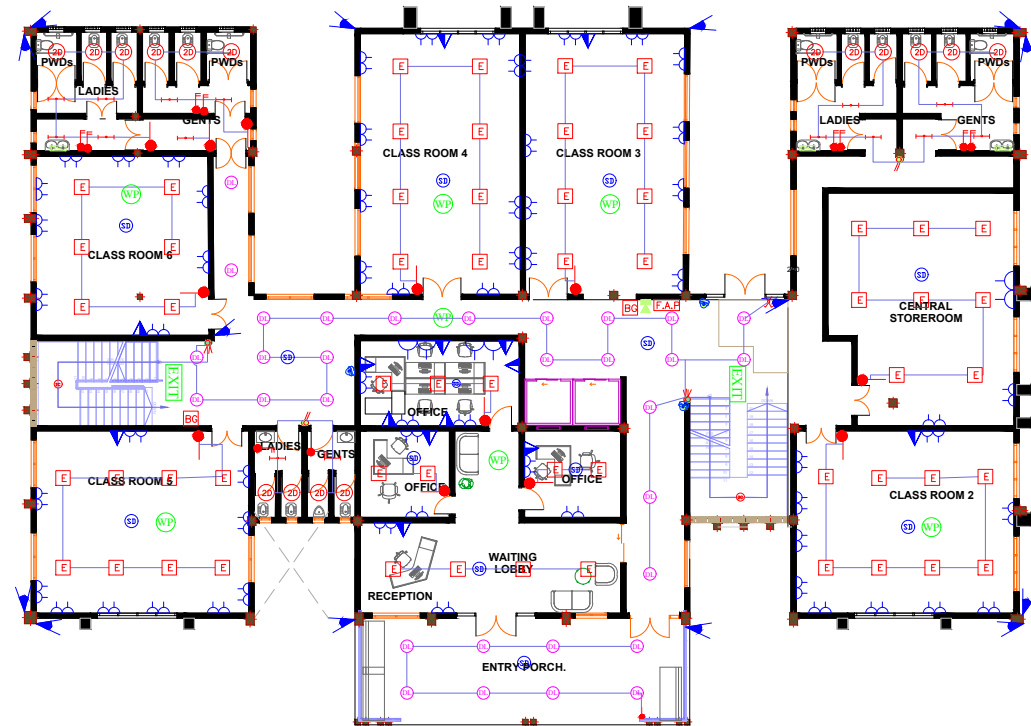

GROUND FLOOR

ELECTRICAL DEVICE SCHEDULE		DESCRIPTION
Quantity	KEY	
3		BULLET TYPE CCTV CAMERA
3		DOME TYPE CCTV CAMERA
13		TWIN DATA POINTS
15		1200MM, 1X36W, 4000K 100LM/W SLIM SECTION, 1P 20 LED BATTEN FITTING WITH AS PHILIPS COZY TMS018 C OR APPROVED EQUIVALENT.
15		1G1W SWITCH
16		SURFACE MOUNTED CIRCULAR 18W DOWNLIGHT
79		13A TWIN SOCKET
8		WIRELESS ACCESS POINT
55		600 X 600 36W LED PANNEL
4		1GANG 2 WAY SWITCH
39		200MM DIA. CIRCULAR RECESSED CEILING LED DOWNLIGHT 11W,
3		MIRROW LIGHT
2		200MM DIA. SURFACE MOUNTAIN CIRCULAR 20W LAMPS
2		EXIT LIGHT
1		INTERMEDIATE SWITCH
2		BREAK GLASS
1		FIRE ALARM SOUND
4		DOUBLE POLE SWITCH
1		2G1W SWITCH
8		SMOKE DETECTOR

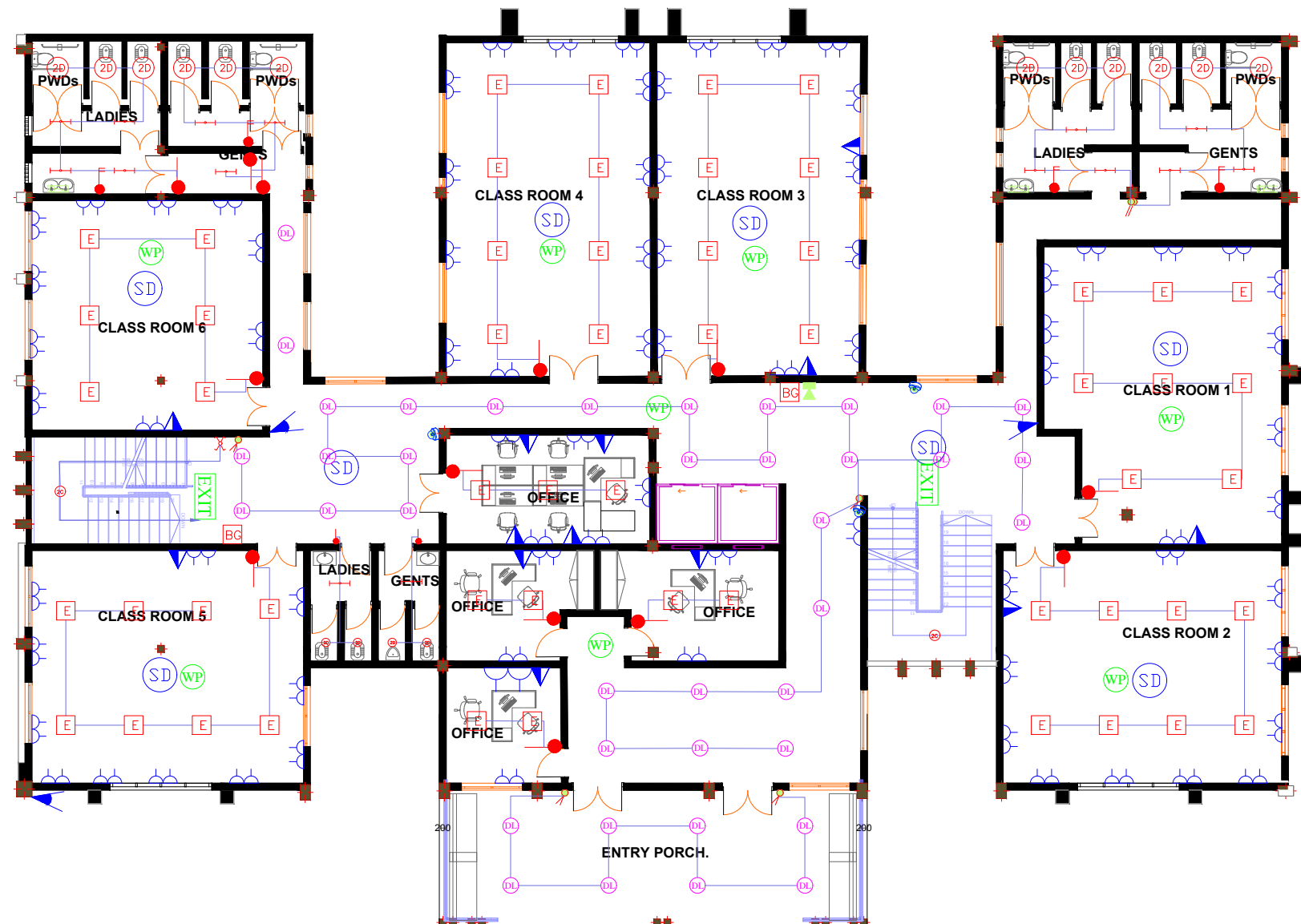

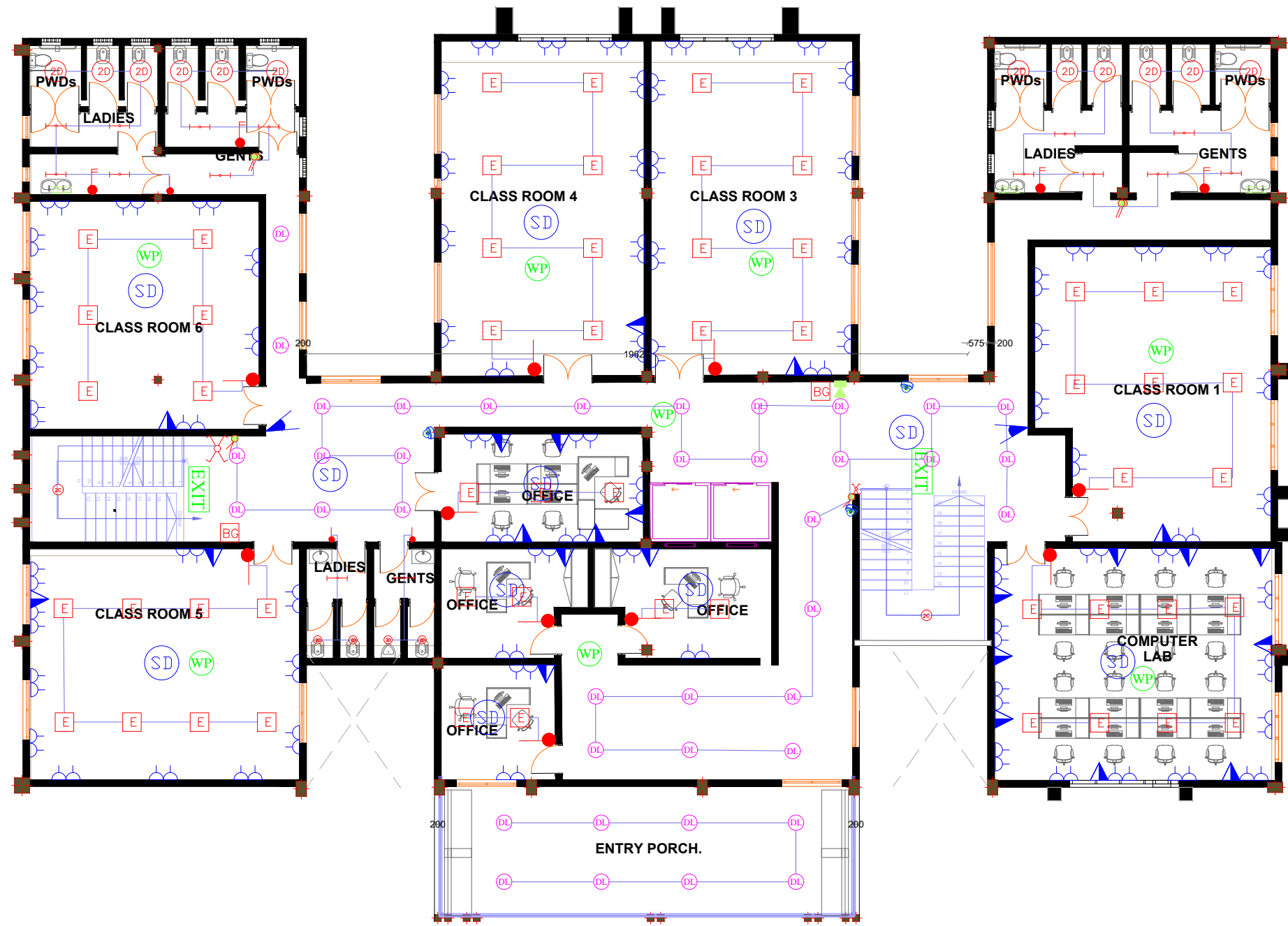

ELECTRICAL DEVICE SCHEDULE		
Quantity	KEY	DESCRIPTION
3		DOME TYPE CCTV CAMERA
2		BULLET TYPE CCTV CAMERA
8		WIRELESS ACCESS POINT
55		600 X 600 36W LED PANNEL
13		1G1W SWITCH
15		1200MM, 1X36W, 4000K 100LM/W SLIM SECTION, 1P 20 LED BATTEN FITTING WITH AS PHILIPS COZY TMS018 C OR APPROVED EQUIVALENT.
16		SURFACE MOUNTED CIRCULAR 18W DOWNLIGHT
23		TWIN DATA POINTS
80		13A TWIN SOCKET
2		INTERMEDIATE SWITCH
39		200MM DIA. CIRCULAR RECESSED CEILING LED DOWNLIGHT 11W,
3		MIRROW LIGHT
2		200MM DIA. SURFACE MOUNTAIN CIRCULAR 20W LAMPS
2		EXIT LIGHT
2		1GANG 2 WAY SWITCH
2		BREAK GLASS
1		FIRE ALARM SOUND
4		DOUBLE POLE SWITCH
2		2G1W SWITCH
12		SMOKE DETECTOR

GROUND FLOOR

ELECTRICAL DEVICE SCHEDULE	
Quantity	KEY
3	●
1	●
2	●
36	▲
4	●
18	●
18	●
50	■
49	■
58	▲
4	■
2	●
2	■
2	■
1	■
4	■
2	■
2	■
13	■
15	●

DESCRIPTION
3 DOME TYPE CCTV CAMERA
1 HEAT DETECTOR
2 BULLET TYPE CCTV CAMERA
36 TWIN DATA POINTS
4 WIRELESS ACCESS POINT
18 1G1W SWITCH
18 SURFACE MOUNTED CIRCULAR 18W DOWNLIGHT
50 600 X 600 36W LED PANNEL
49 200MM DIA. CIRCULAR RECESSED CEILING LED DOWNLIGHT 11W,
58 13A TWIN SOCKET
4 MIRROR LIGHT
2 200MM DIA. SURFACE MOUNTAIN CIRCULAR 20W LAMPS
2 EXIT LIGHT
2 BREAK GLASS
1 FIRE ALARM SOUND
4 DOUBLE POLE SWITCH
2 2 GANG 2 WAY SWITCH
2 2G1W SWITCH
13 1200MM, 1X36W, 4000K 100LM/W SLIM SECTION, 1P 20 LED BATTEN FITTING WITH AS PHILIPS COZY TMS018 C OR APPROVED EQUIVALENT.
15 SMOKE DETECTOR

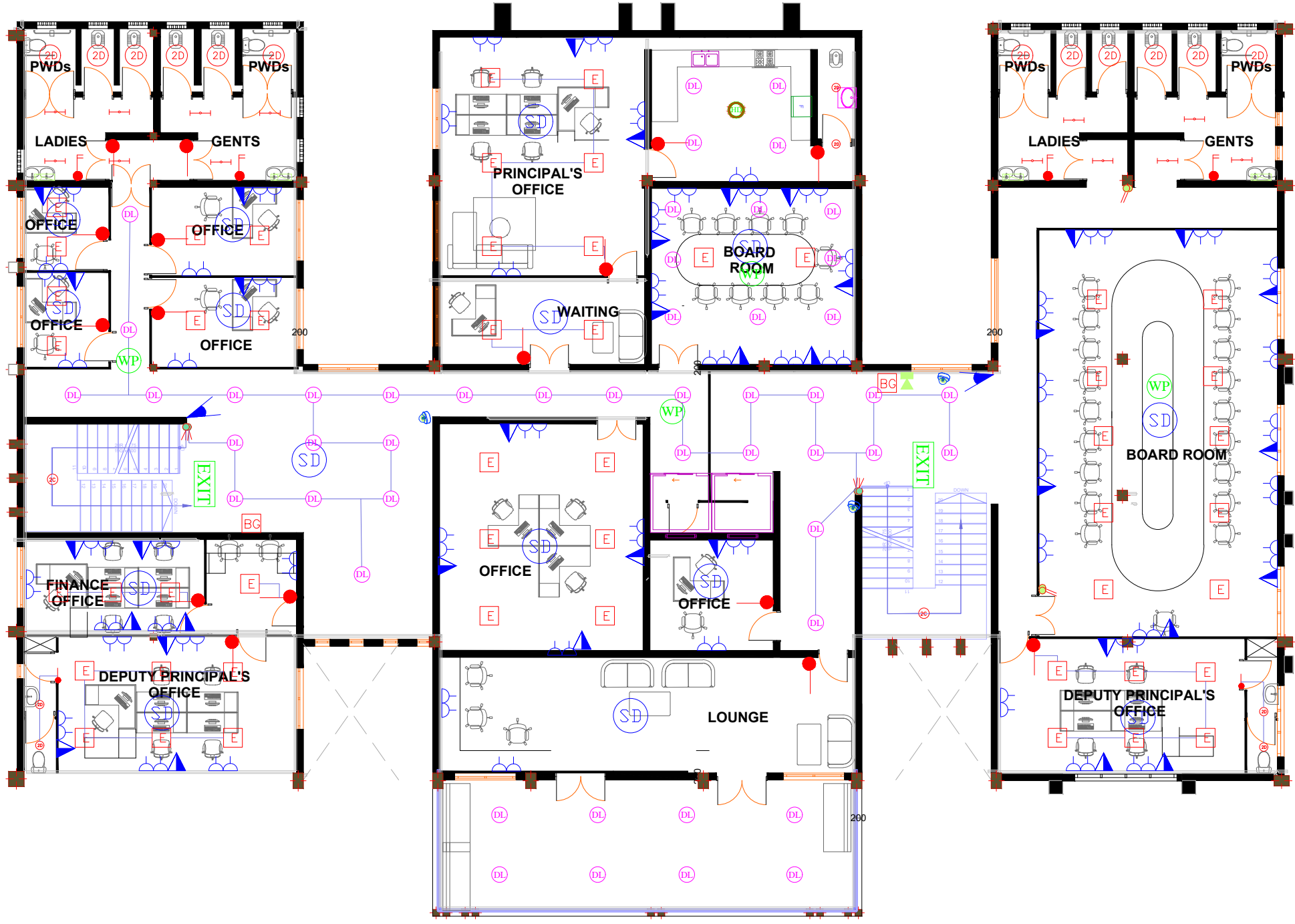

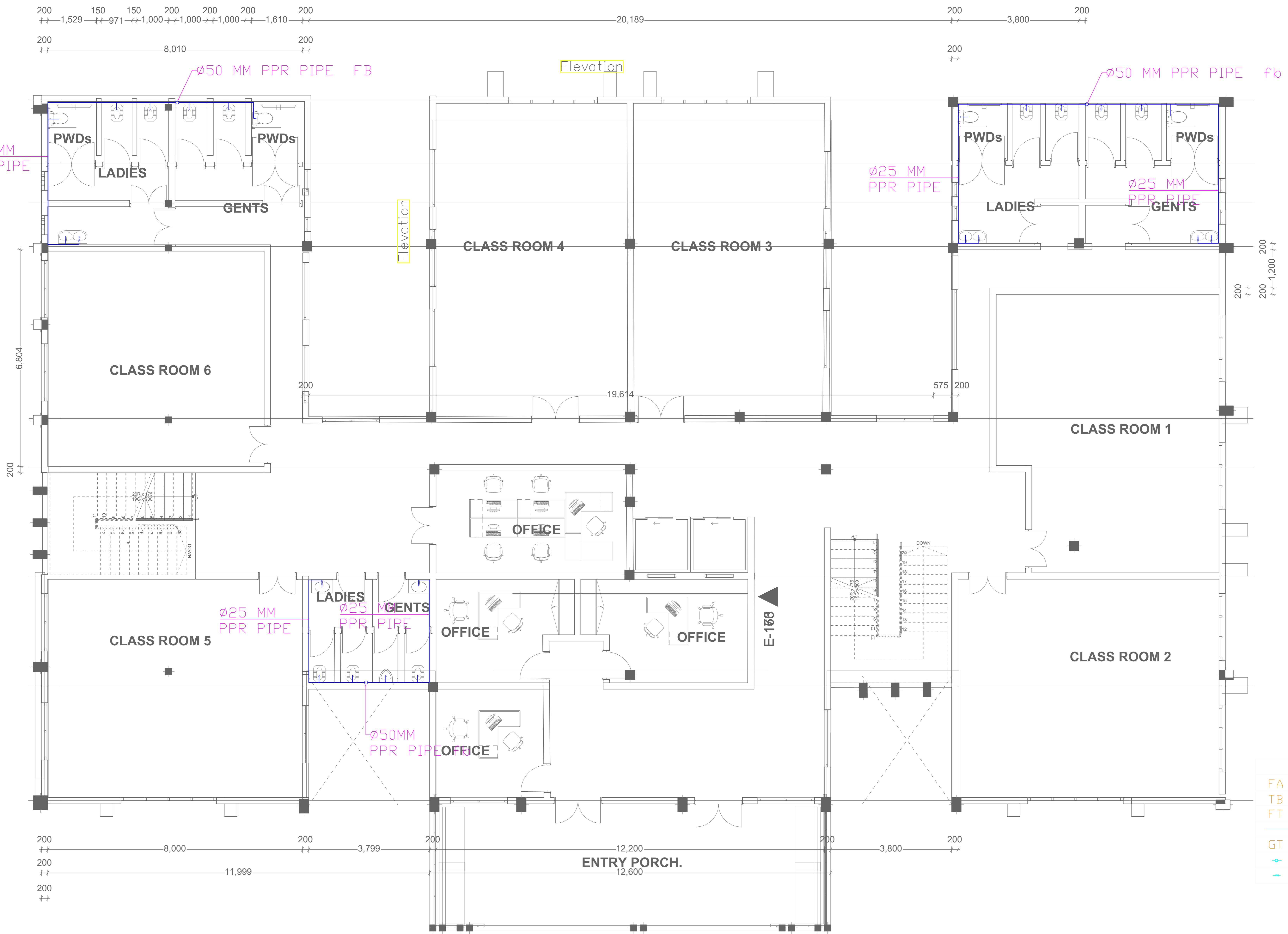

1ST TO 4TH FLOOR PLUMBING

PROJECT NAME:
PROPOSED CONSTRUCTION OF CHAIRMAN'S COMPLEX BLOCK
 CLIENT:
KARUMO TECHNICAL TRAINING COLLEGE

DRAWING	NAME	SIGN	DATE
	Drawn By:	NEWTON NJAGI.	
SCALE	Proj. Dep. T. Leader		
As shown	Proj. Team Leader		

Ministry of Lands, Public Works, Housing and Urban Development

State Department for Public Works.
 Mechanical Department- Eastern Region



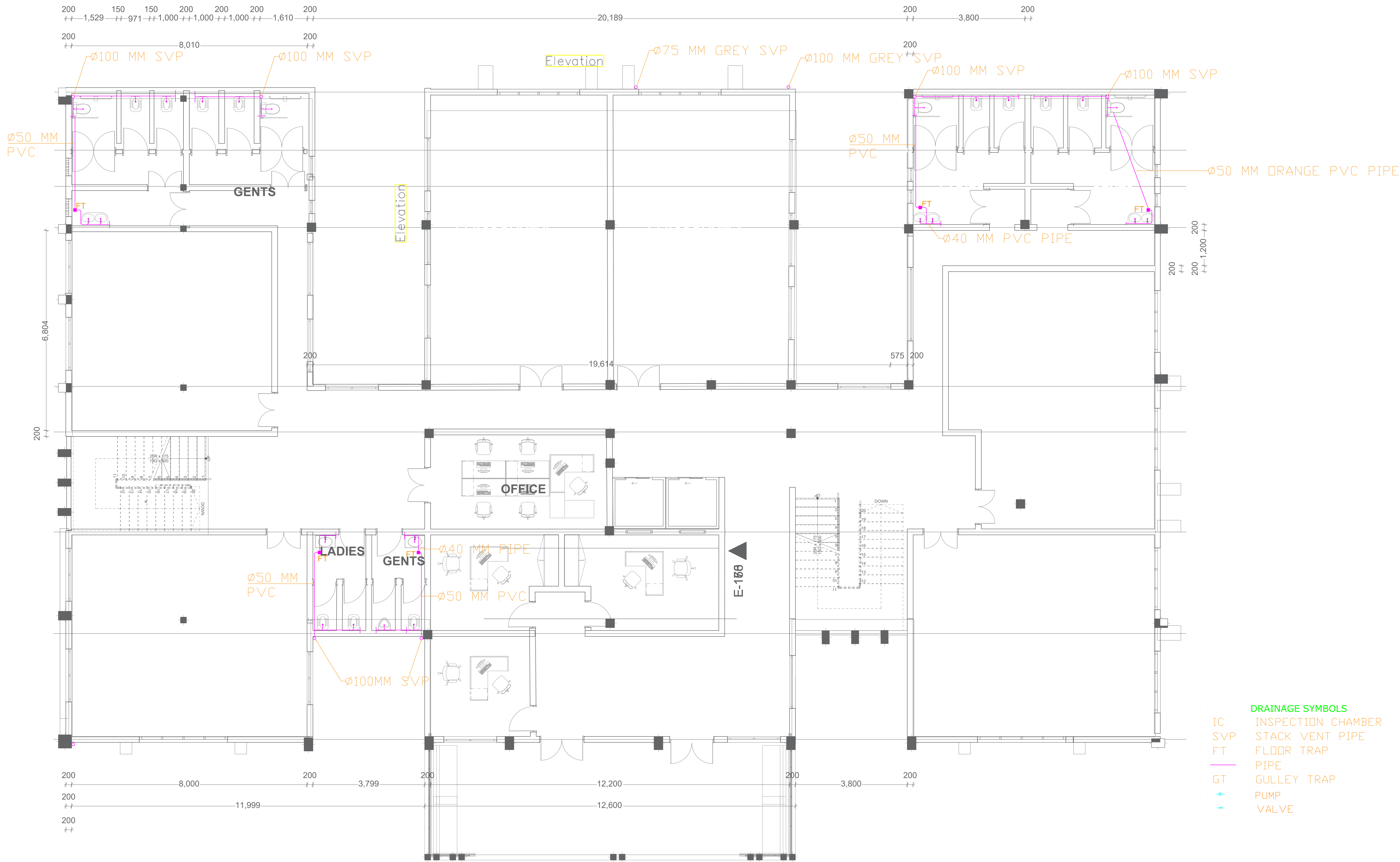

DRAINAGE SYMBOLS	
IC	INSPECTION CHAMBER
SVP	STACK VENT PIPE
FT	FLOOR TRAP
—	PIPE
GT	GULLY TRAP
⊕	PUMP
+	VALVE

1ST TO 4TH FLOOR DRAINAGE

PROJECT NAME:
PROPOSED CONSTRUCTION OF CHAIRMAN'S COMPLEX BLOCK

CLIENT:
KARUMO TECHNICAL TRAINING COLLEGE

DRAWING	NAME	SIGN	DATE
	Drawn By:	NEWTON NJAGI.	
SCALE	Proj. Dep. T. Leader		
As shown	Proj. Team Leader		

Ministry of Lands, Public Works, Housing and Urban Development

State Department for Public Works.
 Mechanical Department- Eastern Region

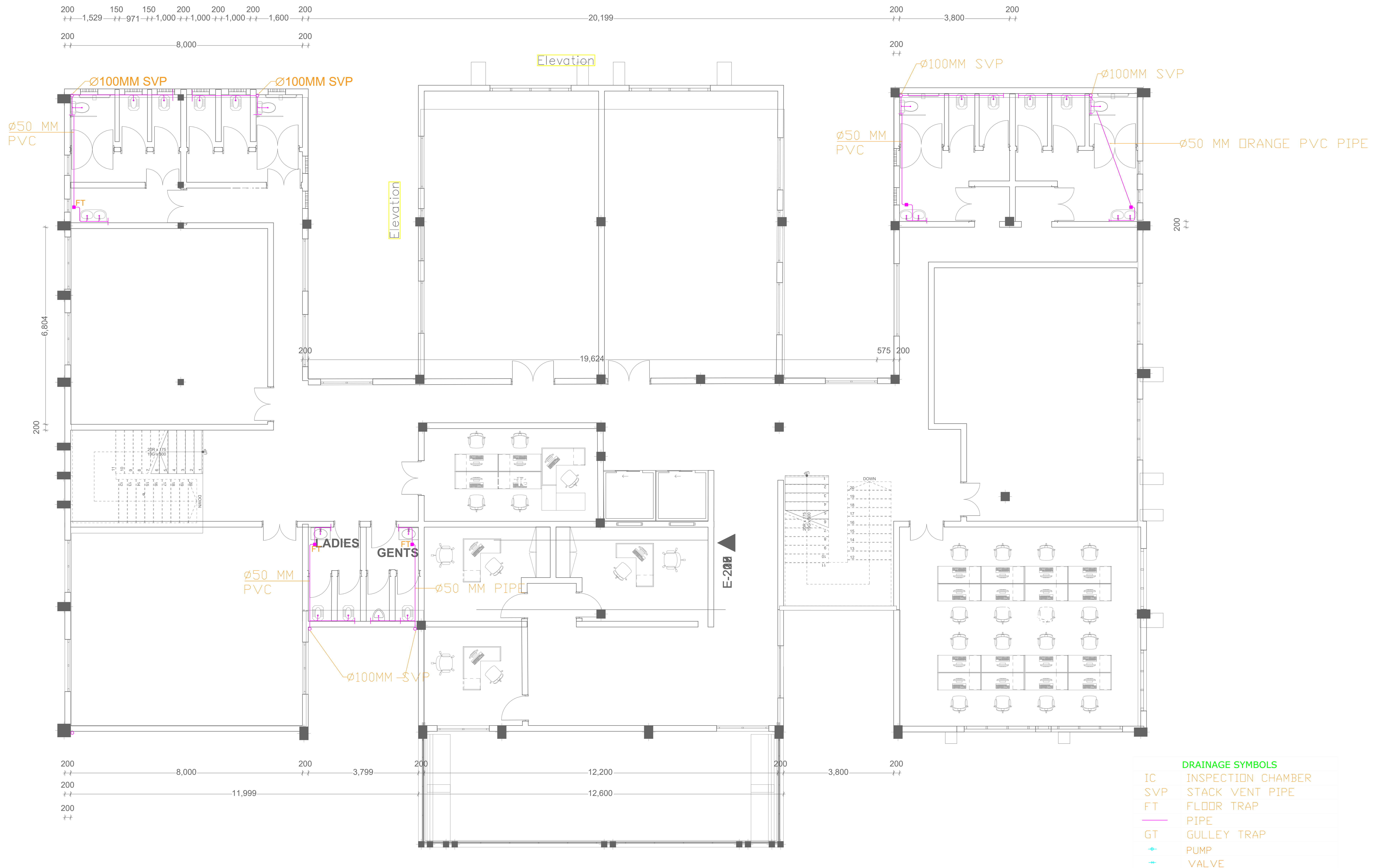

STOREY 5/6 FLOOR DRAINAGE

PROJECT NAME:
PROPOSED CONSTRUCTION OF CHAIRMAN'S COMPLEX BLOCK

CLIENT:
KARUMO TECHNICAL TRAINING COLLEGE

DRAWING	NAME	SIGN	DATE
Drawn By:	NEWTON NJAGI.		
SCALE	Proj. Dep. T. Leader		
As shown	Proj. Team Leader		

Ministry of Lands, Public Works, Housing and Urban Development

State Department for Public Works.

Mechanical Department- Eastern Region





5TH & 6TH FLOOR PLUMBING

PROJECT NAME:
PROPOSED CONSTRUCTION OF CHAIRMAN'S COMPLEX BLOCK
 CLIENT:
KARUMO TECHNICAL TRAINING COLLEGE

DRAWING	NAME	SIGN	DATE
Drawn By:	NEWTON NJAGI.		
SCALE	Proj. Dep. T. Leader		
As shown	Proj. Team Leader		

Ministry of Lands, Public Works, Housing and Urban Development

State Department for Public Works.
 Mechanical Department- Eastern Region



GROUND FLOOR PLUMBING

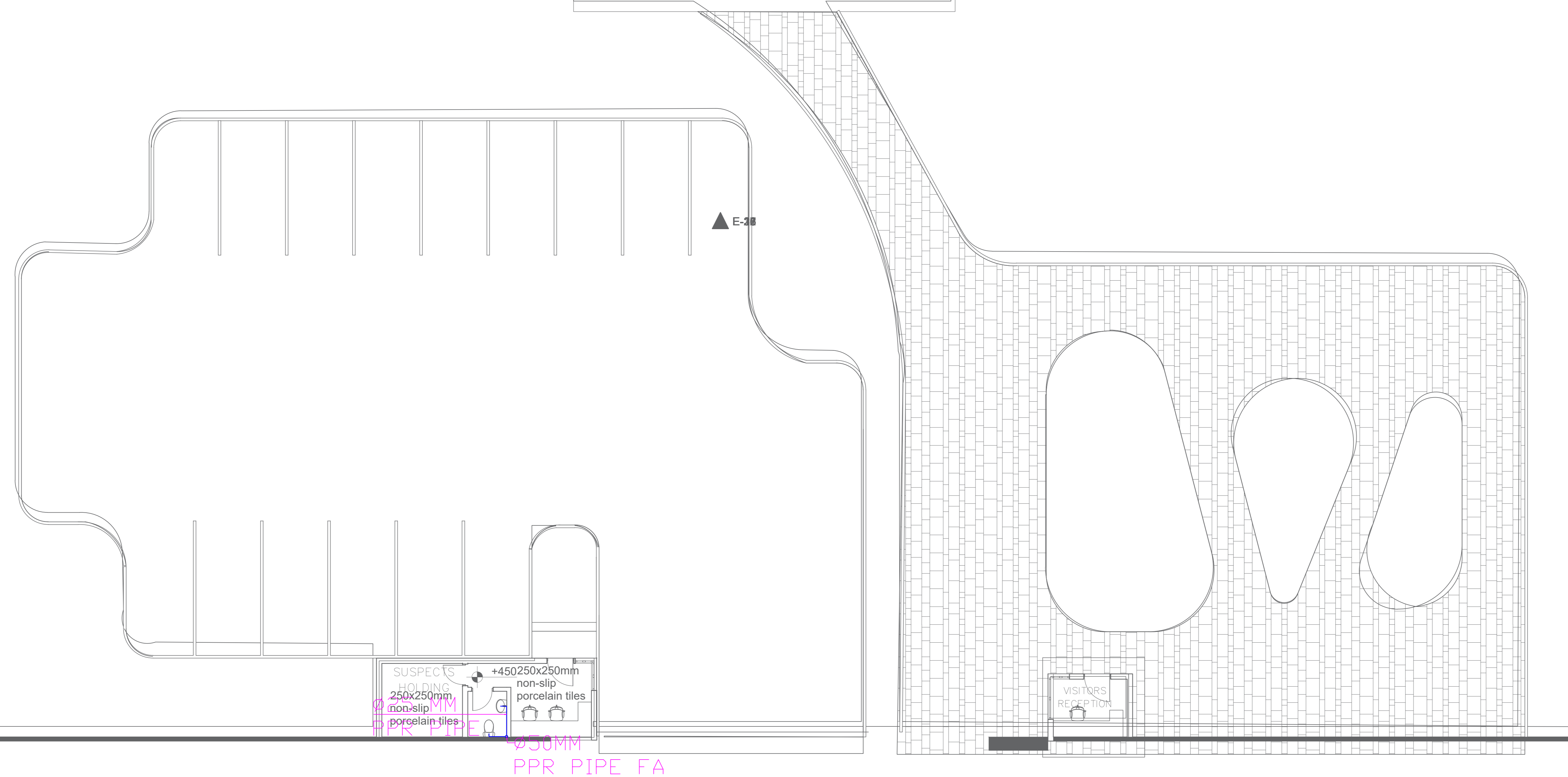
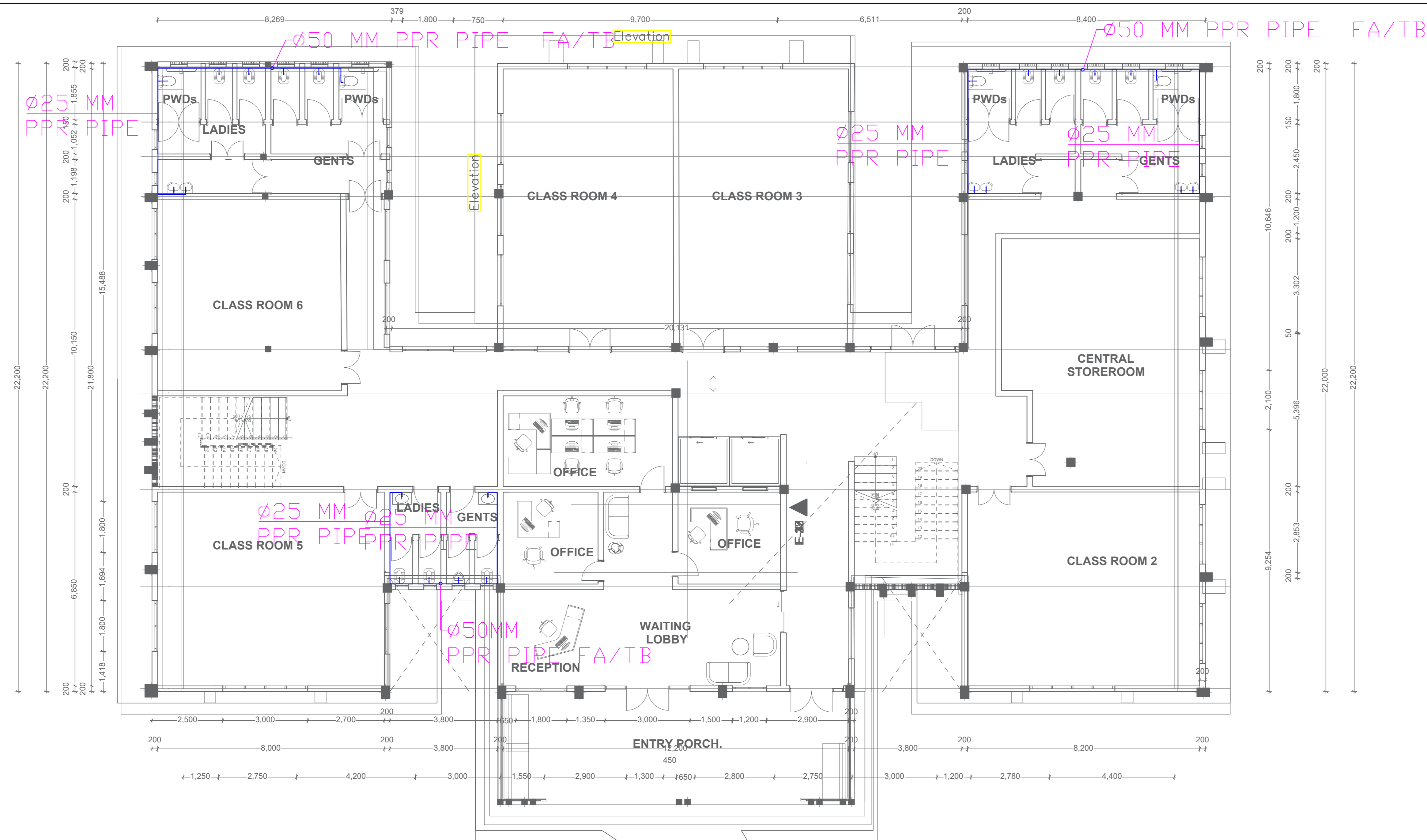

PLUMBING SYMBOLS	
FA	FROM ABOVE
TB	TO BELOW
FT	FLOOR TRAP
—	PIPE
GT	GULLEY TRAP
⊕	PUMP
+	VALVE

PROJECT NAME:
PROPOSED CONSTRUCTION OF CHAIRMAN'S COMPLEX BLOCK

CLIENT:
KARUMO TECHNICAL TRAINING COLLEGE

DRAWING	NAME	SIGN	DATE
Drawn By:	NEWTON NJAGI.		
SCALE	Proj. Dep. T. Leader		
As shown	Proj. Team Leader		

Ministry of Lands, Public Works, Housing and Urban Development

State Department for Public Works.
 Mechanical Department- Eastern Region



PLUMBING SYMBOLS	
FA	FROM ABOVE
TB	TO BELOW
FT	FLOOR TRAP
—	PIPE
GT	GULLEY TRAP
⊕	PUMP
+	VALVE

7TH FLOOR PLUMBING

PROJECT NAME:
PROPOSED CONSTRUCTION OF CHAIRMAN'S COMPLEX BLOCK

CLIENT:
KARUMO TECHNICAL TRAINING COLLEGE

DRAWING	NAME	SIGN	DATE
Drawn By:	NEWTON NJAGI.		
SCALE	Proj. Dep. T. Leader		
As shown	Proj. Team Leader		

Ministry of Lands, Public Works, Housing and Urban Development

State Department for Public Works.
 Mechanical Department- Eastern Region



AIR CONDITIONING SYMBOLS	
	T CONNECTOR
	REFRIGERANT PIPE
	DRAIN PIPE
	DRAIN CAP

7TH FLOOR

7TH FLOOR AIR CONDITIONING

PROJECT NAME:
PROPOSED CONSTRUCTION OF CHAIRMAN'S COMPLEX BLOCK

CLIENT:
KARUMO TECHNICAL TRAINING COLLEGE

DRAWING	NAME	SIGN	DATE
Drawn By:	NEWTON NJAGI.		
SCALE	Proj. Dep. T. Leader		
As shown	Proj. Team Leader		

Ministry of Lands, Public Works, Housing and Urban Development

State Department for Public Works.
 Mechanical Department- Eastern Region

